



EN

Control

T 4.02 - AC/DC Comfort 2.0 (Tetrix 230)

099-00T402-EW501

Observe additional system documents!

04.09.2017

**Register now
and benefit!**
**Jetzt Registrieren
und Profitieren!**

www.ewm-group.com



General instructions

WARNING



Read the operating instructions!

The operating instructions provide an introduction to the safe use of the products.

- Read and observe the operating instructions for all system components, especially the safety instructions and warning notices!
- Observe the accident prevention regulations and any regional regulations!
- The operating instructions must be kept at the location where the machine is operated.
- Safety and warning labels on the machine indicate any possible risks. Keep these labels clean and legible at all times.
- The machine has been constructed to state-of-the-art standards in line with any applicable regulations and industrial standards. Only trained personnel may operate, service and repair the machine.
- Technical changes due to further development in machine technology may lead to a differing welding behaviour.



In the event of queries on installation, commissioning, operation or special conditions at the installation site, or on usage, please contact your sales partner or our customer service department on +49 2680 181-0.

A list of authorised sales partners can be found at www.ewm-group.com.

Liability relating to the operation of this equipment is restricted solely to the function of the equipment. No other form of liability, regardless of type, shall be accepted. This exclusion of liability shall be deemed accepted by the user on commissioning the equipment.

The manufacturer is unable to monitor whether or not these instructions or the conditions and methods are observed during installation, operation, usage and maintenance of the equipment.

An incorrectly performed installation can result in material damage and injure persons as a result. For this reason, we do not accept any responsibility or liability for losses, damages or costs arising from incorrect installation, improper operation or incorrect usage and maintenance or any actions connected to this in any way.

© **EWM AG**

Dr. Günter-Henle-Straße 8

56271 Mündersbach

Germany

The copyright to this document remains the property of the manufacturer.

Copying, including extracts, only permitted with written approval.

The content of this document has been prepared and reviewed with all reasonable care. The information provided is subject to change; errors excepted.

1 Contents

1	Contents	3
2	For your safety	5
2.1	Notes on the use of these operating instructions	5
2.2	Explanation of icons	6
2.3	Part of the complete documentation	7
3	Machine control – Operating elements	8
3.1	Overview of control sections	8
3.1.1	Control section A	9
3.1.2	Control section B	10
3.1.3	Control section C	11
3.2	Machine display	12
3.2.1	Setting the welding current (absolute/percentage)	12
3.3	Operating the machine control	12
3.3.1	Main screen	12
3.3.2	Welding power setting	12
3.3.3	Welding parameter setting in the operation sequence	13
3.3.4	Setting advanced welding parameters (Expert menu)	13
3.3.5	Changing basic settings (machine configuration menu)	13
4	Functional characteristics	14
4.1	TIG welding	14
4.1.1	Gas test – setting the shielding gas volume	14
4.1.2	Welding task selection	15
4.1.2.1	Recurring welding tasks (JOB 1–7)	16
4.1.3	AC welding	16
4.1.3.1	AC balance (optimise cleaning effect and penetration characteristics)	16
4.1.3.2	Tungsten balling function	17
4.1.3.3	Alternating current waveforms	18
4.1.3.4	Automatic AC frequency	18
4.1.4	Arc ignition	19
4.1.4.1	HF ignition	19
4.1.4.2	Liftarc	20
4.1.4.3	Automatic cut-out	20
4.1.5	Operating modes (functional sequences)	21
4.1.5.1	Explanation of symbols	21
4.1.5.2	Non-latched mode	22
4.1.5.3	Latched mode	23
4.1.5.4	spotArc	24
4.1.5.5	spotmatic	26
4.1.6	TIG activArc welding	27
4.1.7	TIG antistick	27
4.1.8	Pulse welding	28
4.1.8.1	Automated pulses	28
4.1.8.2	Thermal pulsing	28
4.1.8.3	Pulsed welding in the upslope and downslope phases	29
4.1.8.4	Average value pulse welding	30
4.1.8.5	Metallurgical pulsing (kHz pulsing)	30
4.1.8.6	AC special	31
4.1.9	Welding torch (operating variants)	32
4.1.9.1	Tapping function (tap torch trigger)	32
4.1.9.2	Torch mode setting	32
4.1.9.3	Up/down speed	32
4.1.9.4	Current jump	32
4.1.9.5	Standard TIG torch (5-pole)	33
4.1.9.6	TIG up/down torch (8-pole)	35
4.1.9.7	Potentiometer torch (8-pole)	36
4.1.9.8	Configuring the TIG potentiometer torch connection	38
4.1.9.9	RETOX TIG torch (12-pole)	38
4.1.10	Expert menu (TIG)	39

4.2	MMA welding.....	40
4.2.1	Welding task selection.....	40
4.2.2	Hotstart.....	40
4.2.2.1	Hotstart current.....	40
4.2.2.2	Hotstart time.....	41
4.2.3	Antistick.....	41
4.2.4	Welding current polarity reversal (polarity reversal).....	41
4.2.5	Average value pulse welding.....	42
4.3	Power-saving mode (Standby).....	42
4.4	Access control.....	43
4.5	Voltage reducing device.....	43
4.6	Machine configuration menu.....	44
4.6.1	Selecting, changing and saving parameters.....	44
5	Rectifying faults.....	47
5.1	Error messages (power source).....	47
5.2	Dynamic power adjustment.....	47
5.3	Resetting welding parameters to the factory settings.....	48
5.4	Display machine control software version.....	48
6	Appendix A.....	49
6.1	Parameter overview – setting ranges.....	49
6.1.1	TIG welding.....	49
6.1.2	MMA welding.....	50
7	Appendix B.....	51
7.1	Overview of EWM branches.....	51

2 For your safety

2.1 Notes on the use of these operating instructions

DANGER

Working or operating procedures which must be closely observed to prevent imminent serious and even fatal injuries.

- Safety notes include the "DANGER" keyword in the heading with a general warning symbol.
- The hazard is also highlighted using a symbol on the edge of the page.

WARNING

Working or operating procedures which must be closely observed to prevent serious and even fatal injuries.

- Safety notes include the "WARNING" keyword in the heading with a general warning symbol.
- The hazard is also highlighted using a symbol in the page margin.

CAUTION

Working or operating procedures which must be closely observed to prevent possible minor personal injury.

- The safety information includes the "CAUTION" keyword in its heading with a general warning symbol.
- The risk is explained using a symbol on the edge of the page.



Special technical points which users must observe.

Instructions and lists detailing step-by-step actions for given situations can be recognised via bullet points, e.g.:

- Insert the welding current lead socket into the relevant socket and lock.

2.2 Explanation of icons

Symbol	Description	Symbol	Description
	Indicates technical aspects which the user must observe.		Activate and release/tap/tip
	Switch off machine		Release
	Switch on machine		Press and keep pressed
			Switch
	Wrong		Turn
	Correct		Numerical value – adjustable
	Menu entry		Signal light lights up in green
	Navigating the menu		Signal light flashes green
	Exit menu		Signal light lights up in red
	Time representation (e.g.: wait 4 s/activate)		Signal light flashes red
	Interruption in the menu display (other setting options possible)		
	Tool not required/do not use		
	Tool required/use		

2.3 Part of the complete documentation

 **These operating instructions are part of the complete documentation and valid only in combination with all other parts of these instructions! Read and observe the operating instructions for all system components, especially the safety instructions!**

The illustration shows a general example of a welding system.

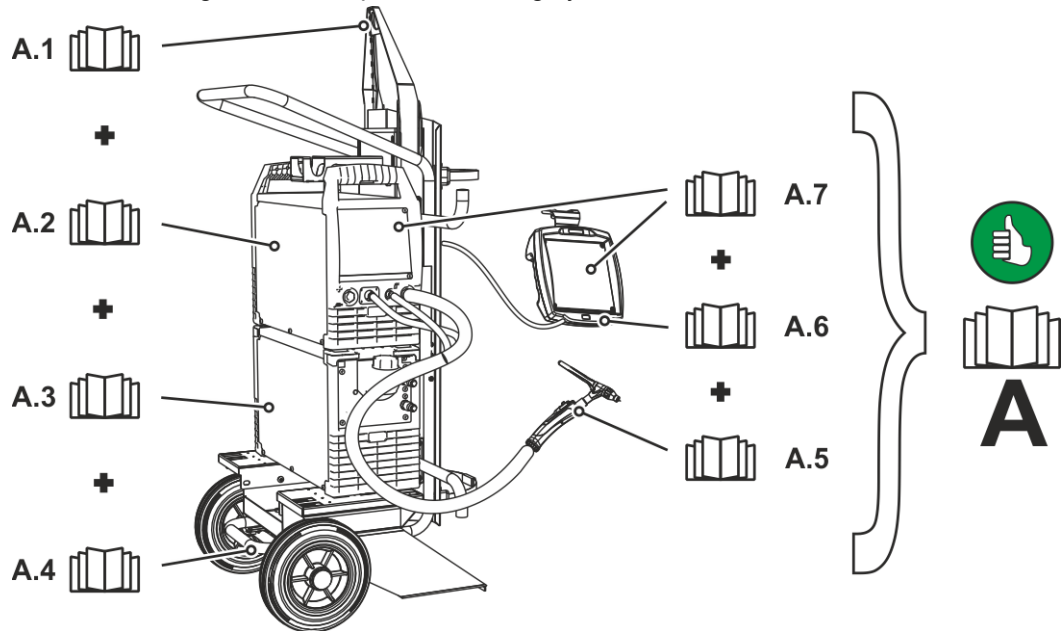

Figure 2-1

Item	Documentation
A.1	Options conversion instructions
A.2	Power source
A.3	Cooling unit, voltage converter, tool box etc.
A.4	Transport cart
A.5	Welding torch
A.6	Remote control
A.7	Control
A	Complete documentation

3 Machine control – Operating elements

3.1 Overview of control sections

For description purposes, the machine control has been divided into three sections (A, B, C) to ensure maximum clarity. The setting range for the parameter values are summarised in the parameter overview section > see 6.1 chapter.

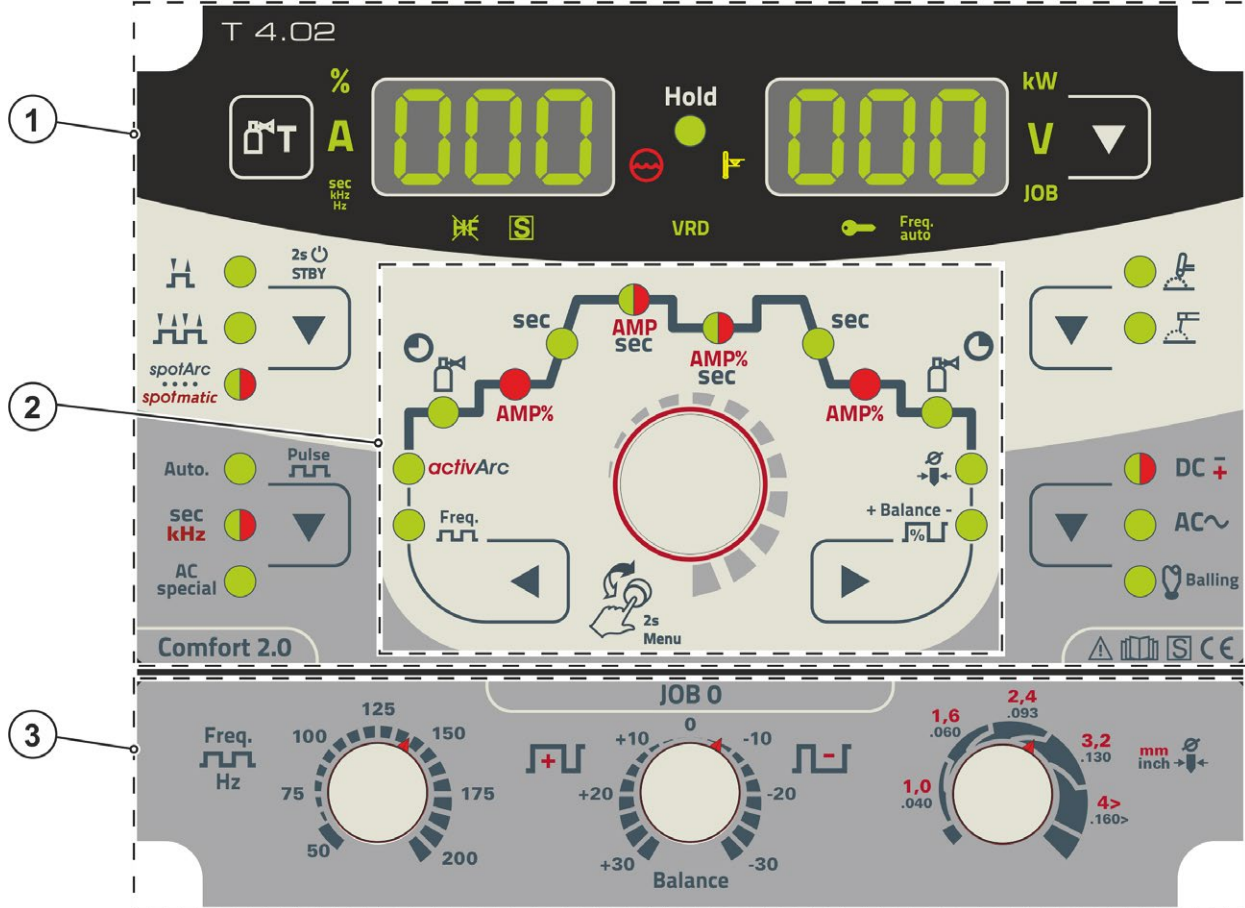

Figure 3-1

Item	Symbol	Description
1		Control section A > see 3.1.1 chapter
2		Control section B > see 3.1.2 chapter
3		Control section C > see 3.1.3 chapter

3.1.1 Control section A

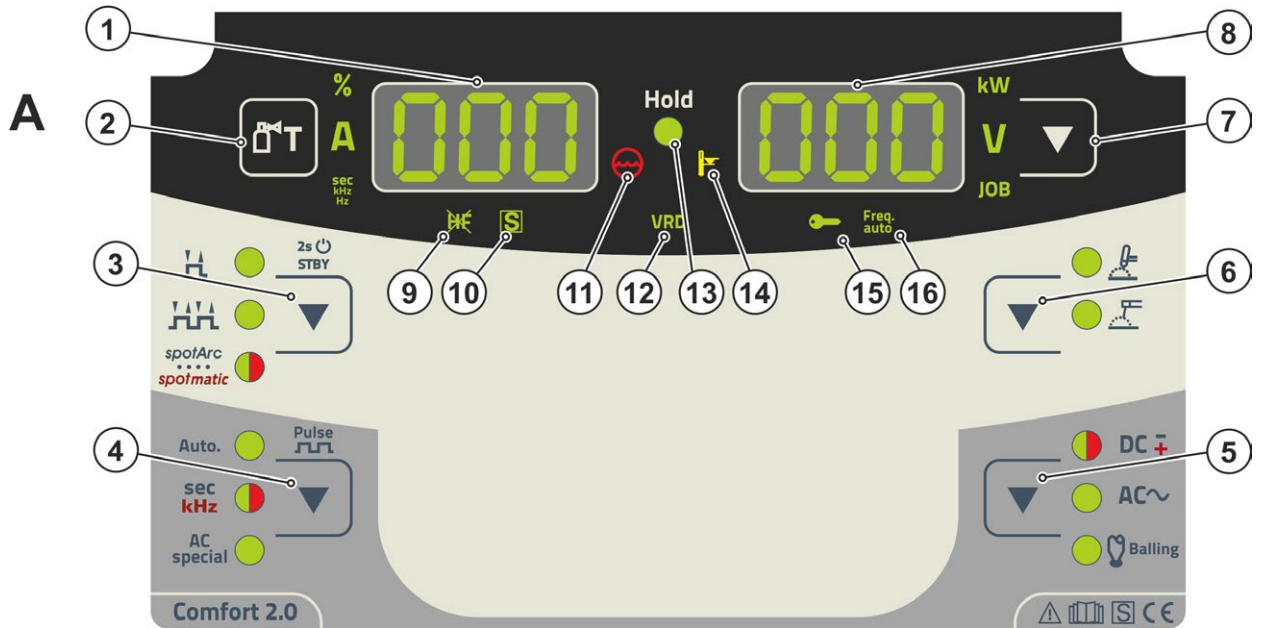

Figure 3-2

Item	Symbol	Description
1		Welding data display (3-digit) Displays the welding parameters and the corresponding values > see 3.2 chapter
2		Gas test push-button > see 4.1.1 chapter
3		Operating mode > see 4.1.5 chapter / power-saving mode push-button > see 4.3 chapter ----- Latched ----- Non-latched ----- spotArc spot welding procedure – signal light turns green ----- spotmatic spot welding procedure –signal light turns red ----- Press button for long interval to put machine into power-saving mode. Activate one of the operating elements to reactivate.
4		Pulsing push-button > see 4.1.8 chapter ----- Automated pulsing (frequency and balance) ----- Signal light turns green: Thermal pulsed TIG welding/MMA pulse welding/average value pulsing ----- Signal light turns red: Metallurgical pulsed TIG welding (kHz pulsing) ----- Special TIG AC
5		Welding current polarity/tungsten balling push-button ----- Signal light turns green: DC welding with negative polarity on the electrode holder or welding torch. ----- Signal light turns red: MMA DC welding with positive polarity on the electrode holder > see 4.2.4 chapter. ----- Alternating current welding/alternating current forms > see 4.1.3.3 chapter ----- Tungsten balling current > see 4.1.3.2 chapter
6		Welding procedure push-button ----- TIG welding ----- MMA welding

Item	Symbol	Description
7	▼	Display switching push-button kW ----- Welding power display V ----- Welding voltage display JOB ----- Display and setting of the JOB number with the control button
8	000	Welding data display (3-digit) Displays the welding parameters and the corresponding values > see 3.2 chapter
9	⚡	TIG ignition type signal light Signal light on: Lift arc ignition active/HF start off. You can switch the ignition type in the Expert menu (TIG) > see 4.1.10 chapter.
10	S	Character S function signal light Indicates that it is possible to weld in an environment with major electric hazards, such as in boilers. Service must be informed if this signal light is not on.
11	⊙	Coolant fault signal light Signals pressure loss or low coolant level in the coolant circuit.
12	VRD	Voltage reduction device (VRD) signal light The VRD signal light is illuminated when the voltage reduction device is operating without fault and the output voltage is reduced to a value specified in the relevant standard (see technical data) > see 4.5 chapter. The voltage reduction device is only active on VRD machine versions.
13	Hold	Signal light Status display After each completed welding task, the last values used in the welding process for the welding current and welding voltage are shown on the displays, and the signal light will be on
14	🔥	Excess temperature signal light In case of excess temperature, temperature monitors de-activate the power unit, and the excess temperature control lamp comes on. Once the machine has cooled down, welding can continue without any further measures.
15	🔑	Access control active signal light Signal light is on when access control is active on the machine control > see 4.4 chapter.
16	Freq. auto	Automatic AC frequency > see 4.1.3.4 chapter

3.1.2 Control section B

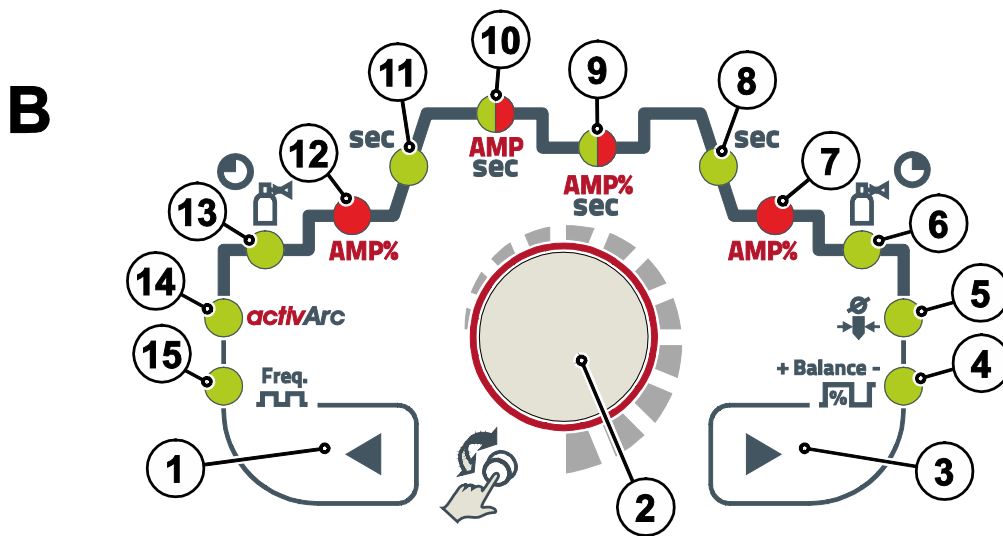

Figure 3-3

Item	Symbol	Description
1	◀	Parameter selection push-button, left The welding sequence parameters are selected one after another in an anti-clockwise direction.

Item	Symbol	Description
2		Control button Central control button to be pressed or turned > see 3.3 chapter.
3		Parameter selection push-button, right The welding sequence parameters are selected one after another in a clockwise direction.
4		Balance signal light \overline{bAL} AC balance (JOBS 1–7), pulse balance
5		Electrode diameter signal light \overline{ndR} Ignition optimisation (TIG)/tungsten balling basic setting (JOB 1-100)
6		Gas post-flow time \overline{GPE}
7	AMP%	End current signal light \overline{Ed}
8	sec	Down-slope time \overline{Edn} signal light
9	AMP% sec	Signal light, two colour Red: Secondary or pulse pause current \overline{Ez} (% of AMP) Green: Pulse pause time \overline{Ez}
10	AMP sec	Signal light, two colour Red: Main current \overline{Ei} /pulse current \overline{EPL} Green: Pulse time \overline{Ei}
11	sec	Signal light Up-slope time \overline{EUP} (TIG)/hot start time \overline{EhE} (MMA)
12	AMP%	Signal light Ignition current $\overline{E5E}$ (TIG)/hot start current \overline{EhE} (MMA)
13		Gas pre-flow time signal light \overline{GPr}
14	activArc	Signal light activArc \overline{AR} > see 4.1.6 chapter
15		\overline{FrE} signal light AC frequency (TIG, JOBS 1–7)/pulse frequency (TIG, average value pulsing)/pulse frequency (MMA)

3.1.3 Control section C

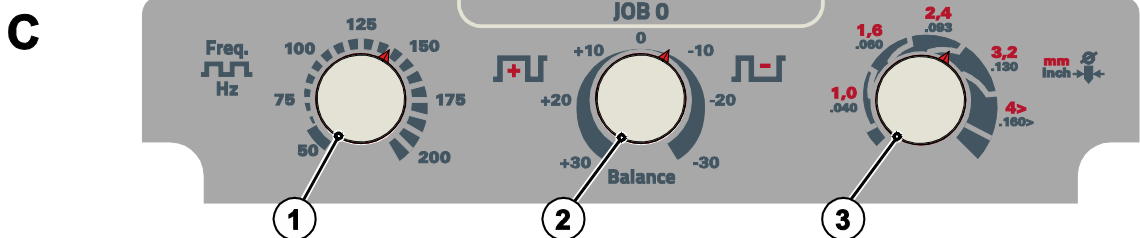

Figure 3-4

Item	Symbol	Description
1		AC frequency rotary knob (JOB 0)
2	Balance	AC balance rotary knob (JOB 0)
3		Tungsten electrode diameter rotary knob (JOB 0)

3.2 Machine display

The following welding parameters can be displayed before (nominal values), during (actual values) or after welding (hold values):

"left display"			
Parameter	Before welding (nominal values)	During welding (actual values)	After welding (hold values)
Welding current	<input checked="" type="checkbox"/>	<input checked="" type="checkbox"/>	<input checked="" type="checkbox"/>
Parameter times	<input checked="" type="checkbox"/>	<input type="checkbox"/>	<input type="checkbox"/>
Parameter currents	<input checked="" type="checkbox"/>	<input type="checkbox"/>	<input type="checkbox"/>
Frequency, balance	<input checked="" type="checkbox"/>	<input type="checkbox"/>	<input type="checkbox"/>
JOB number	<input checked="" type="checkbox"/>	<input type="checkbox"/>	<input type="checkbox"/>
"right display"			
Welding power	<input type="checkbox"/>	<input checked="" type="checkbox"/>	<input checked="" type="checkbox"/>
Welding voltage	<input checked="" type="checkbox"/>	<input checked="" type="checkbox"/>	<input checked="" type="checkbox"/>

When the hold values are displayed after welding and the settings are then changed (e.g. welding current), the display will switch to the relevant nominal values.

possible

not possible

The parameters that can be set in the function sequence of the machine control depend on the selected welding task. This means that if for example you have not selected a pulse variant, then you cannot set any pulse times in the function sequence.

3.2.1 Setting the welding current (absolute/percentage)

The welding current for the ignition, secondary, end and hot start current can be set as a percentage of the main current AMP or as an absolute value. To select, use the parameter [F55](#) in the configuration menu_ref_source_inline>Gerätekonfigurationsmenü</dg_ref_source_inline>.

> see 4.6 chapter

3.3 Operating the machine control

3.3.1 Main screen

The machine control switches to the main screen after it has been turned on or a setting has been completed. This means that the previously selected settings (indicated by signal lights where applicable) and the nominal value for the current (A) are displayed in the left-hand welding data display. Depending on the selection, the right-hand display shows the welding voltage (V) nominal value or the welding power (kW) actual value. The control always switches back to the main screen after 4 sec. of inactivity.

3.3.2 Welding power setting

The welding power is set using the control button. You can also adjust the parameters in the operation sequence or settings in the different machine menus.

3.3.3 Welding parameter setting in the operation sequence

A welding parameter can be set in two ways in the operation sequence.

1. Push the "left" or "right" arrow keys (flashing signal light will indicate your selection). Turn the control button to set the parameter value.
2. Press briefly on the control button (operation sequence selection) and then turn the button (navigate to the required parameter). Press again to apply the selected parameter as the setting (corresponding parameter value and signal light flash). Turn the button to set the parameter value.

During welding parameter setting, the parameter value to be set flashes in the left hand display. A parameter abbreviation or a deviation in the specified parameter value upwards or downwards is shown on the right-hand display:

Display	Meaning
	Increase the parameter value To return to the factory settings.
	Factory setting (example value = 20) Parameter is set to optimum value
	Decrease the parameter value To return to the factory settings.

3.3.4 Setting advanced welding parameters (Expert menu)

The Expert menu contains functions and parameters which cannot be set directly in the machine control or which do not need to be set on a regular basis. The number and display of these parameters depends on the previously selected welding procedure or the functions.

To select them hold the control button for more than 2 sec. Select the required parameter/menu item by turning (navigate) and pressing (confirm) the control button.

You can also or alternatively use the push-buttons to the left and right of the control button to navigate.

3.3.5 Changing basic settings (machine configuration menu)

The basic welding system functions can be adjusted in the machine configuration menu. Only experienced users should change the settings > see 4.6 chapter.

4 Functional characteristics

4.1 TIG welding

4.1.1 Gas test – setting the shielding gas volume

- Slowly open the gas cylinder valve.
- Open the pressure regulator.
- Switch on the power source at the main switch.
- Set the relevant gas quantity for the application on the pressure regulator.
- The gas test can be activated at the machine control by pressing the "Gas test"  push-button > see 3.1.1 chapter.

Setting the shielding gas quantity (gas test)

- Shielding gas flows for approx. 20 seconds or until the push-button is pressed again.

If the shielding gas setting is too low or too high, this can introduce air to the weld pool and may cause pores to form. Adjust the shielding gas quantity to suit the welding task!

Setting instructions

Welding process	Recommended shielding gas quantity
MAG welding	Wire diameter x 11.5 = l/min
MIG brazing	Wire diameter x 11.5 = l/min
MIG welding (aluminium)	Wire diameter x 13.5 = l/min (100 % argon)
TIG	Gas nozzle diameter in mm corresponds to l/min gas throughput

Helium-rich gas mixtures require a higher gas volume!

The table below can be used to correct the gas volume calculated where necessary:

Shielding gas	Factor
75% Ar/25% He	1.14
50% Ar/50% He	1.35
25% Ar/75% He	1.75
100% He	3.16



For connecting the shielding gas supply and handling the shielding gas cylinder refer to the power source operating instructions.

4.1.2 Welding task selection

The setting of the tungsten electrode diameter has a direct influence on the machine functionality, TIG ignition behaviour and minimum current limits. The ignition energy is controlled by the set electrode diameter. Smaller electrode diameters requires less ignition current and less ignition current time than greater electrode diameters. The set value should correspond to the tungsten electrode diameter. The value can also be set to meet individual requirements, e.g. for thin panels a smaller diameter is recommended to reduce the ignition energy.

The following welding task is an example of use:

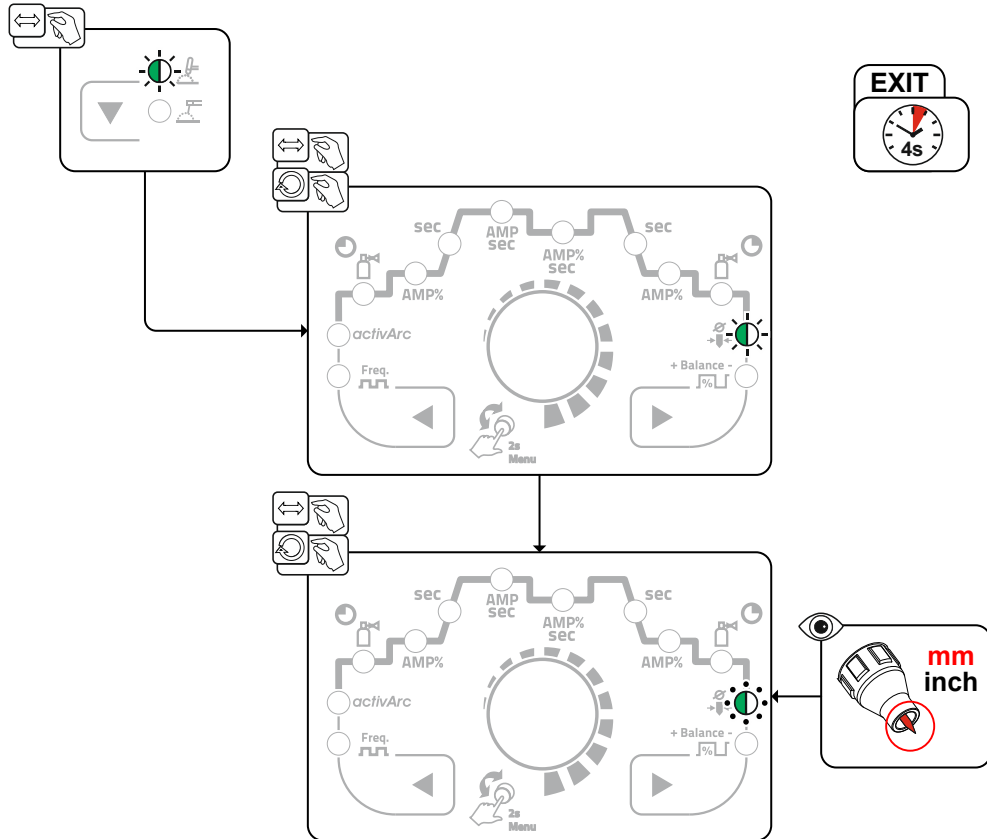

Figure 4-1

4.1.2.1 Recurring welding tasks (JOB 1–7)

The user has 7 more memory locations at their disposal to save recurring or different welding tasks on a permanent basis. To do so, simply select the required memory location (JOB 1–7) and the welding task is set as described previously.

The three rotary knobs for AC frequency, AC balance and the tungsten electrode diameter are exceptions. These settings are made in the operation sequence (signal lights with same name).

Switching a JOB is only possible if no welding current flows. Up-slope and down-slope times can be set individually for latched and non-latched operation.

Selection

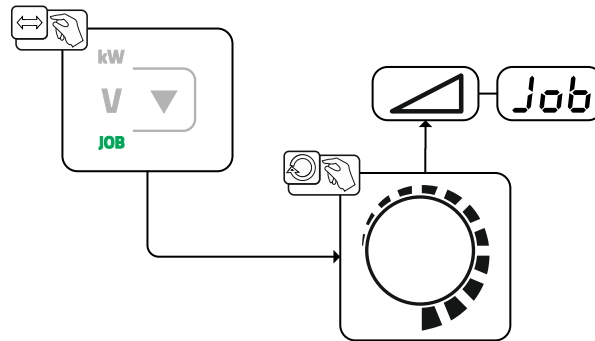

Figure 4-2

When one or more of the recurring welding tasks (JOB 1–7) has been selected the JOB signal light comes on.

4.1.3 AC welding

4.1.3.1 AC balance (optimise cleaning effect and penetration characteristics)

To weld aluminium and aluminium alloys, AC welding is used in combination with a continuous change in polarity of the tungsten electrode. The process encompasses two phases (half-waves): a positive and a negative one. The positive phase cracks the aluminium oxide layer on the material surface (so called cleaning effect).

At the same time, tungsten balling occurs at the tip of the tungsten electrode. The size of this balled end depends on the length of the positive phase. Please note that an excessively big balled end will cause the arc to become unstable and diffuse, with low penetration. In the negative phase, the tungsten electrode is cooled and the required penetration is realised. Make sure to select the correct durations (balance) for positive phase (cleaning effect, balled end size) and negative phase (penetration depth) by setting the AC balance. The default (zero setting) balance setting is 65%, referring to the duration of the negative half-wave.

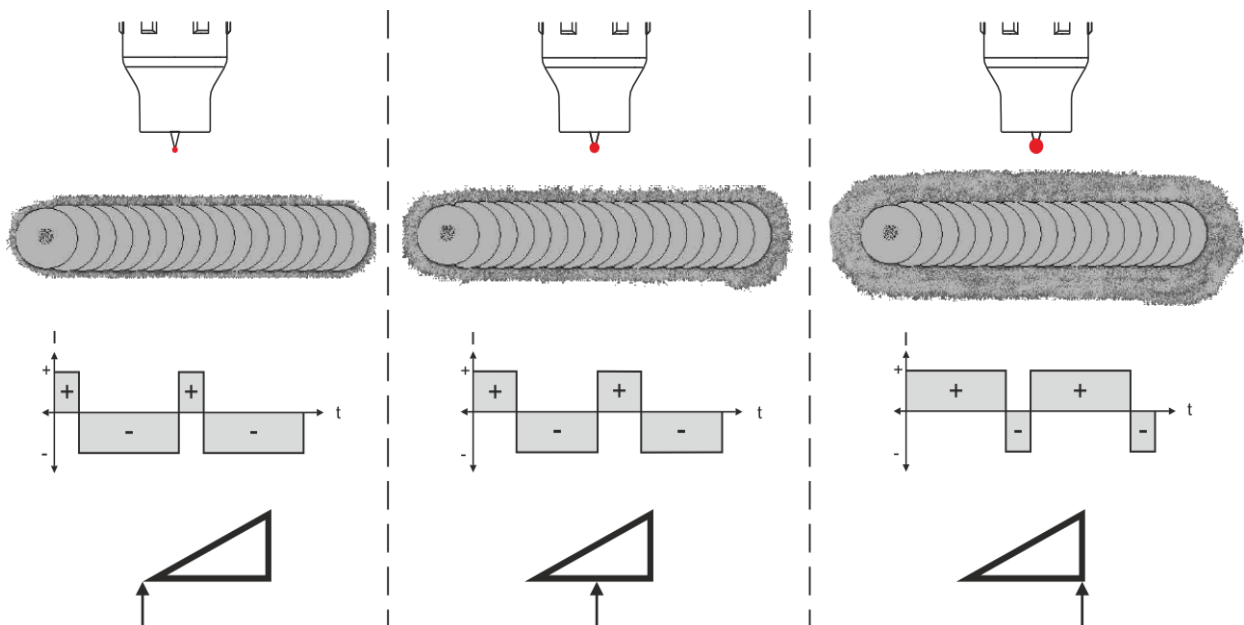

Figure 4-3

4.1.3.2 Tungsten balling function

The tungsten balling function provides optimum tungsten balling, ensuring that the best ignition and welding results are achieved during AC welding.

Optimum tungsten balling requires a sharpened electrode (about 15–25°) and the set electrode diameter on the machine control. The set electrode diameter affects the current for tungsten balling and, consequently, also the ball size.

Press the tungsten balling push-button to activate the function. If required, this current can be adjusted on an individual basis using the I_c parameter (+/- 30 A). The user presses the torch trigger and the function is started by non-contact ignition (HF start). The balled end is formed and the function then ends.

Tungsten balling should be performed on a test component as surplus tungsten may be melted and this may lead to impurities on the weld seam.

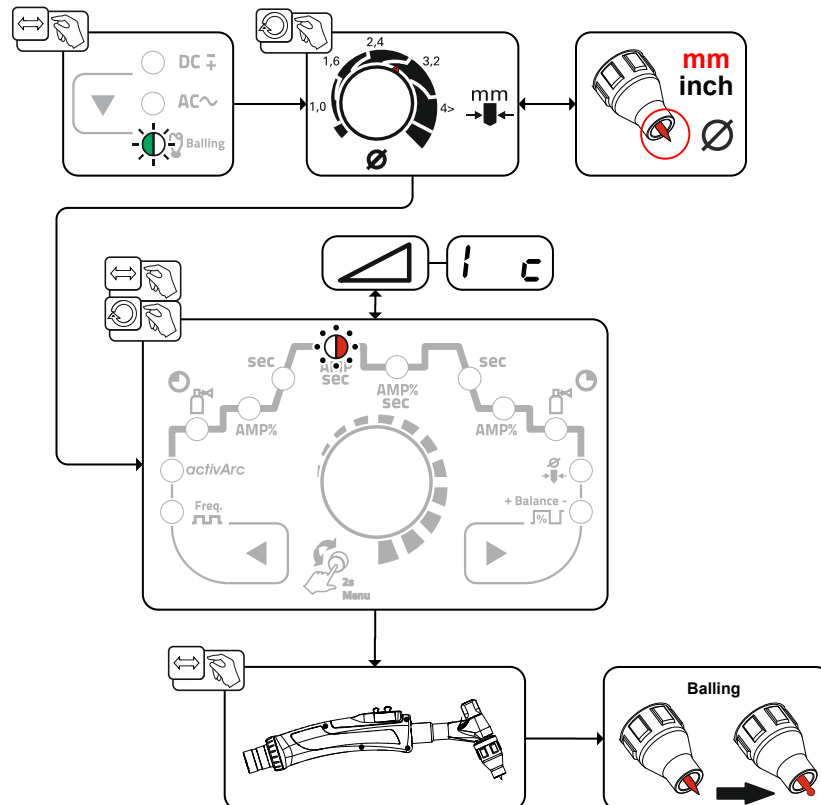

Figure 4-4

4.1.3.3 Alternating current waveforms Selection

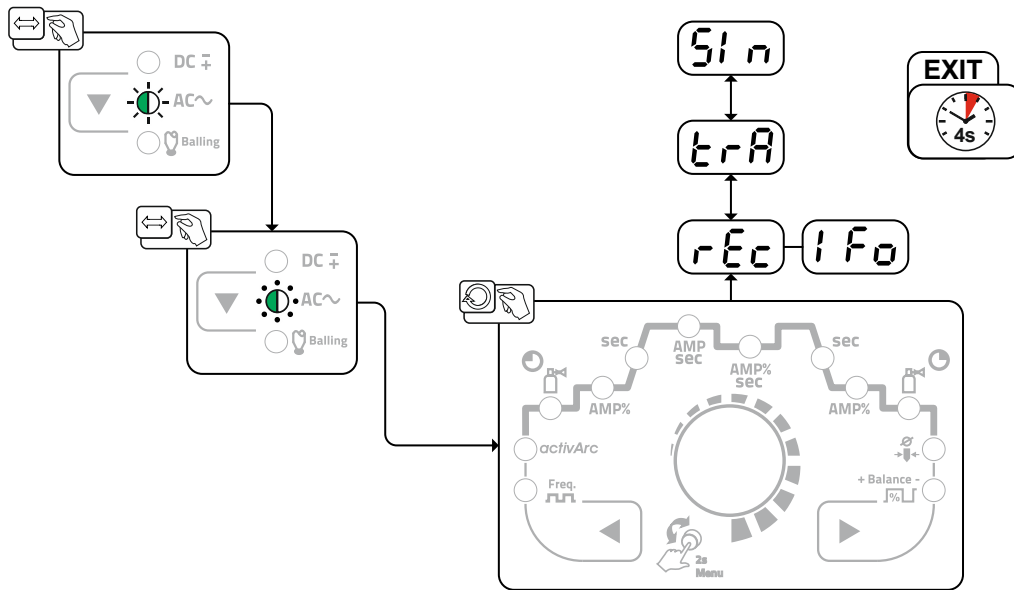

Figure 4-5

Display	Setting/selection
I Fo	Alternating current waveforms ¹
rEc	----- Rectangular - Highest energy input (ex works)
t r A	----- Trapezoidal - An all-rounder, suitable for most applications
S i n	----- Sine - Low noise level

4.1.3.4 Automatic AC frequency

Automatic AC frequency can be selected for JOB 1-100 only. The left stop in the frequency functional sequence **Freq. auto** is used for activation, displayed as **Auto**.

The signal light **Freq. auto** comes on when the function is activated.

The machine control adjusts or sets the AC frequency in relation to the set main current. The lower the welding current, the higher the frequency and vice versa. This ensures a concentrated, directionally stable arc is achieved when welding currents are low. The load from the tungsten electrode is minimised when the welding currents are high, ensuring a longer service life.

The use of a foot-operated remote control with this function reduces manual intervention by the user during the welding process to a minimum.

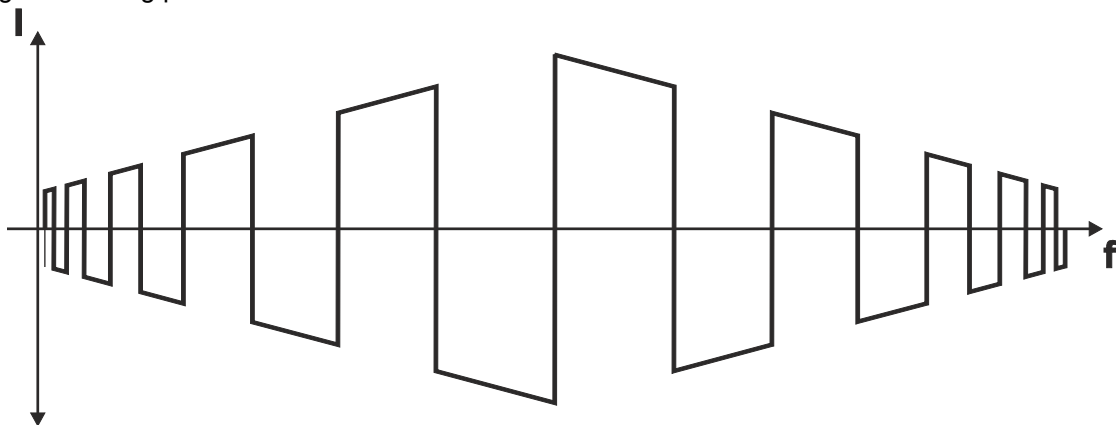

Figure 4-6

Selection

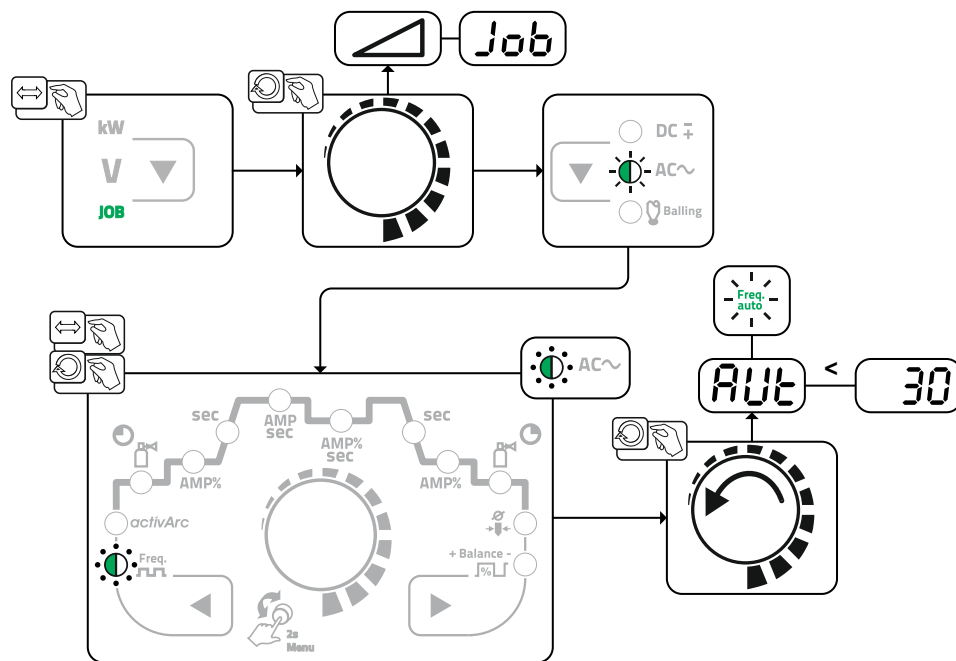

Figure 4-7

4.1.4 Arc ignition

To change the ignition type, use parameter **hF** to switch between HF start (**on**) and lift arc (**off**) in the Expert menu > see 4.1.10 chapter.

4.1.4.1 HF ignition

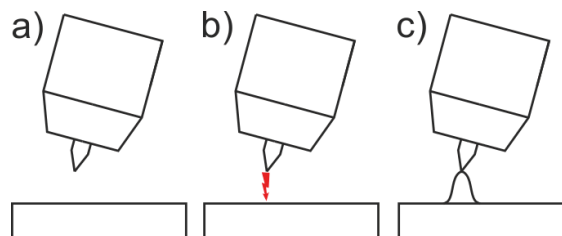

Figure 4-8

The arc is started without contact from high-voltage ignition pulses.

- Position the welding torch in welding position over the workpiece (distance between the electrode tip and workpiece should be approx. 2-3mm).
- Press the torch trigger (high voltage ignition pulses ignite the arc).
- Ignition current flows, and the welding process is continued depending on the operating mode selected.

End the welding process: Release or press the torch trigger depending on the operating mode selected.

4.1.4.2 Liftarc

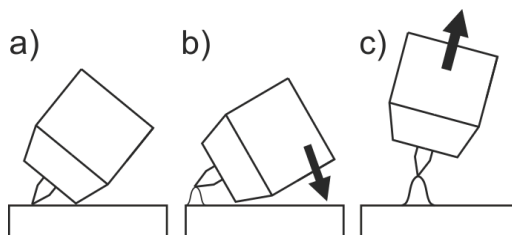

Figure 4-9

The arc is ignited on contact with the workpiece:

- a) Carefully place the torch gas nozzle and tungsten electrode tip onto the workpiece and press the torch trigger (liftarc current flowing, regardless of the main current set).
- b) Incline the torch over the torch gas nozzle to produce a gap of approx. 2-3 mm between the electrode tip and the workpiece. The arc ignites and the welding current is increased, depending on the operating mode set, to the ignition or main current set.
- c) Lift off the torch and swivel to the normal position.

Ending the welding process: Release or press the torch trigger depending on the operating mode selected.







4.1.4.3 Automatic cut-out

Once the fault periods have elapsed, the automatic cut-out stops the welding process when it has been triggered by one of two states:

- During ignition
3 s after the start of the welding process, no welding current flows (ignition error).
- During welding
The arc is interrupted for more than 3 s (arc interruption).

4.1.5 Operating modes (functional sequences)

4.1.5.1 Explanation of symbols

Symbol	Meaning
	Press torch trigger 1
	Release torch trigger 1
I	Current
t	Time
  GPr	Gas pre-flow
I _{SE}	Ignition current
t _{UP}	Up-slope time
t _P	Spot time
I ₁ AMP	Main current (minimum to maximum current)
I ₂ AMP%	Secondary current
t ₁	Pulse time
t ₂	Pulse pause time
t _{dn}	Down-slope time
I _{Ed}	End-crater current
  GPE	Gas post-flow
bAL	Balance
FrE	Frequency

4.1.5.2 Non-latched mode Selection

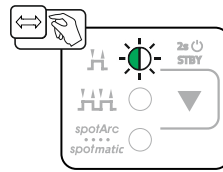

Figure 4-10

Sequence

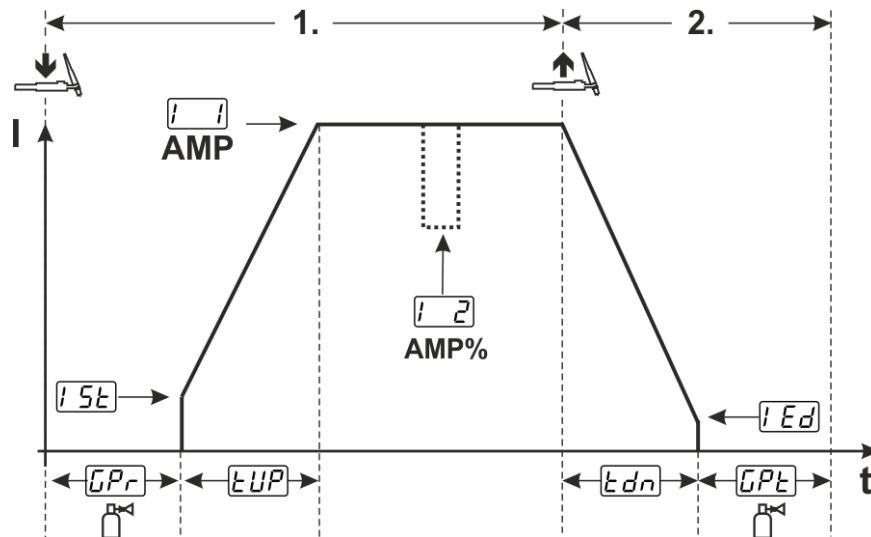

Figure 4-11

1st cycle:

- Press torch trigger 1 and hold down.
- Gas pre-flow time GPr elapses.
- HF ignition pulses jump from the electrode to the workpiece. The arc ignites.
- The welding current flows and immediately assumes the value of the ignition current iSt .
- HF switches off.
- The welding current ramps up to the main current I_1 (AMP) in the selected up-slope time tUP .

If torch trigger 2 is pressed together with torch trigger 1 during the main current phase, the welding current decreases to the secondary current I_2 (AMP%).

If torch trigger 2 is released, the welding current increases again to the main current AMP.

2nd cycle:

- Release torch trigger 1.
 - The main current falls to the end-crater current IEd (minimum current) in the set down-slope time tdn .
- If the 1st torch trigger is pressed during the down-slope time, the welding current returns to the set main current AMP.
- Main current reaches the end-crater current IEd ; the arc is extinguished.
 - Set gas post-flow time $GPEt$ elapses.

When the foot-operated remote control is connected, the machine switches automatically to non-latched operation. The up- and down-slopes are switched off.

4.1.5.3 Latched mode
Selection

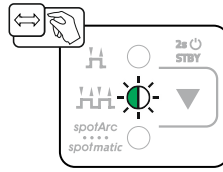

Figure 4-12

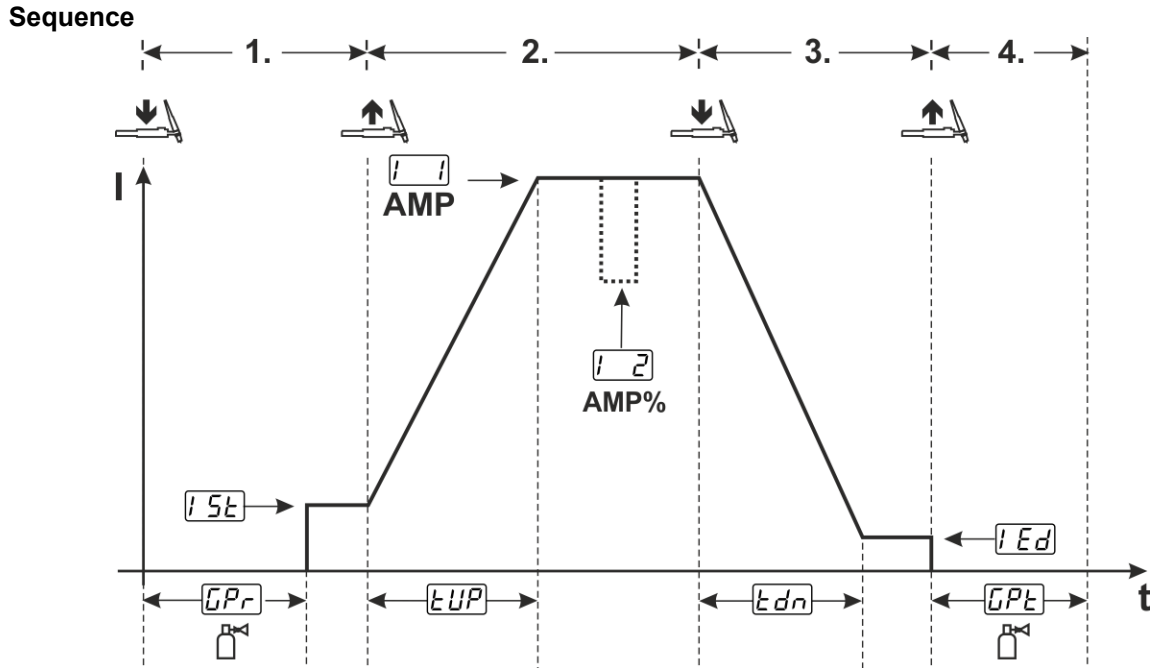

Figure 4-13

1st cycle

- Press torch trigger 1; gas pre-flow time t_{Pr} elapses.
- HF ignition pulses jump from the electrode to the workpiece. The arc ignites.
- Welding current flows and immediately assumes the set ignition current I_{SE} (search arc at minimum setting). HF switches off.

2nd cycle

- Release torch trigger 1.
- The welding current ramps up to the main current I_{A} (AMP) in the selected up-slope time t_{UP} .

Switching from the main current AMP to secondary current I_{2} (AMP%):

- Press torch trigger 2 or
- Tap torch trigger 1 (torch modes 1–6).

3rd cycle

- Press torch trigger 1.
- The main current decreases to the end-crater current I_{Ed} within the set down-slope time t_{dn} .

4th cycle

- Release torch trigger 1; arc is extinguished.
- Set gas post-flow time t_{PE} runs.

Ending the welding process immediately without a down-slope or end-crater current:

- Press the 1st torch trigger briefly > 3rd and 4th cycles (torch modes 11–16).
Current drops to zero and the gas post-flow time begins.

When the foot-operated remote control is connected, the machine switches automatically to non-latched operation. The up- and down-slopes are switched off.



A double-digit torch mode (11-x) needs to be set at the welding machine control to use the alternative welding start (tapping start). The number of torch modes available depends on the machine type.

4.1.5.4 spotArc

This process is suitable for tack welding or joint welding of metal sheets made from steel and CrNi alloys up to a thickness of approximately 2.5 mm. Metal sheets of different thicknesses can also be welded on top of one another. As this is a one-sided process, it is also possible to weld metal sheets onto tubular sections such as round or square pipes. In arc spot welding, the arc melts through the upper metal sheet and the lower metal sheet is melted onto it. This produces flat, fine-textured welding tacks which require little or no post weld work, even in visible areas.

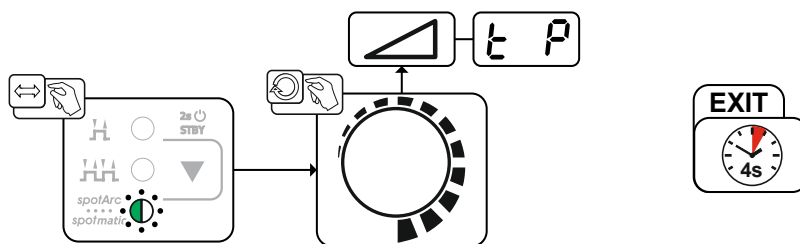

Figure 4-14



The up-slope and down-slope times should be set to "0" to achieve an effective result.

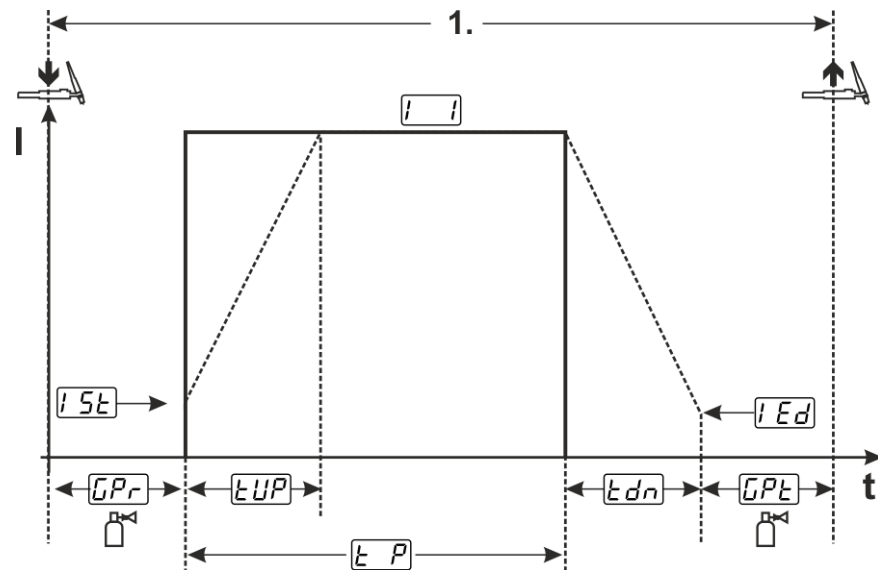

Figure 4-15

As an example the process is shown with HF ignition. Arc ignition with lift arc is also possible, however > see 4.1.4 chapter.

Sequence:

- Press torch trigger and hold down.
- The gas pre-flow time elapses.
- HF start pulses jump from the electrode to the workpiece. The arc ignites.

The welding current flows and immediately assumes the value of the ignition current I_{5t}

- HF switches off.
- The welding current ramps up to the main current I_p (AMP) within the set up-slope time t_{UP} .

The process ends when the set spotArc.time elapses or by releasing the torch trigger. With the spotArc function enabled, the Automatic Puls pulse variant is activated as well. If required, the function can be disabled by pressing the pulsed welding push-button.

4.1.5.5 spotmatic

In contrast to the spotArc operating mode, the arc is not ignited by pressing the torch trigger as is usual, but by briefly touching the tungsten electrode against the workpiece. The torch trigger is used for welding process activation. Activation is indicated by flashing of the spotArc/spotmatic signal light. The process can be activated separately for each spot or also on a permanent basis. The setting is controlled using the $[55P]$ process activation parameter in the configuration menu > see 4.6 chapter.

- Separate process activation ($[55P] > [on]$):
The welding process has to be reactivated for every arc ignition by pressing the torch trigger. Process activation is automatically terminated after 30 s of inactivity.
- Permanent process activation ($[55P] > [off]$):
The welding process is activated by pressing the torch trigger once. The following arc ignitions are initiated by shortly touching the tungsten electrode against the workpiece. Process activation is terminated either by pressing the torch trigger again or automatically after 30 s of inactivity.

For spotmatic the separate process activation and the short spot time setting range are enabled by default.

Ignition by touching the tungsten electrode against the workpiece can be disabled in the machine configuration menu with parameter $[577]$. In this case the function works as with spotArc, but the spot time setting range can be selected in the machine configuration menu.

The duration is set in the machine configuration menu using parameter $[5t5]$ > see 4.6 chapter

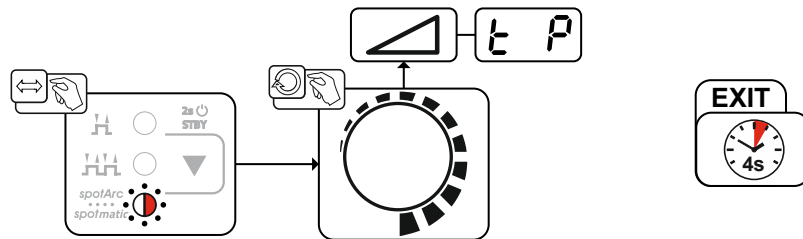

Figure 4-16

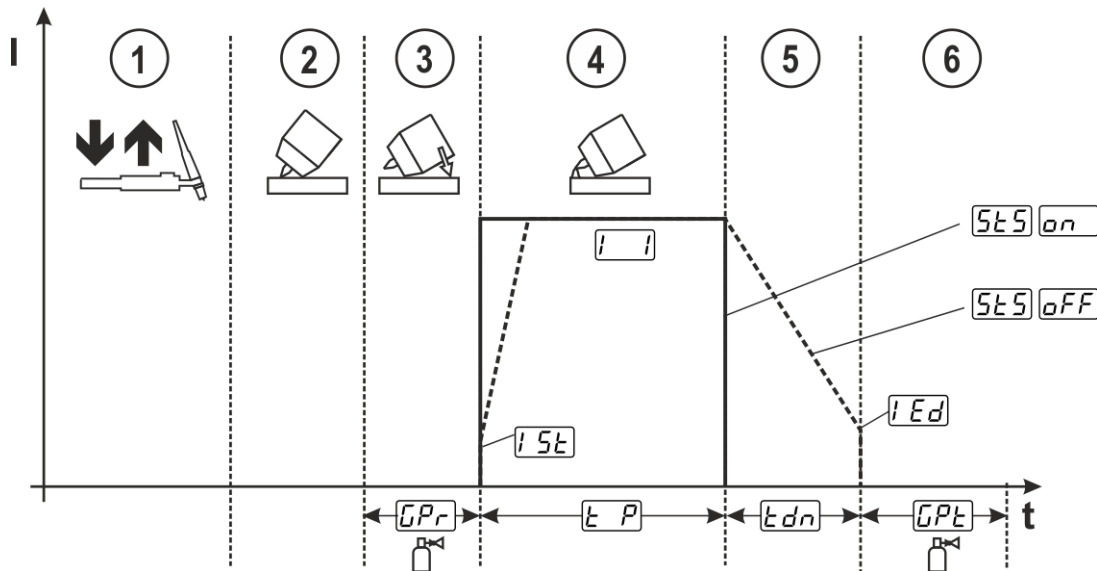

Figure 4-17

As an example the process is shown with HF ignition. Arc ignition with lift arc is also possible, however > see 4.1.4 chapter.

Selecting the process activation type for the welding process > see 4.6 chapter.

Up-slope and down-slope times possible for long spot time setting range (0.01–20.0 s) only.

- ① Press and release torch trigger (tap) to activate the welding process.
- ② Touch the torch gas nozzle and tungsten electrode tip carefully against the workpiece.
- ③ Incline the welding torch over the torch gas nozzle until there is a gap of approx. 2–3 mm between the electrode tip and the workpiece. Shielding gas flows during the set gas pre-flow time \overline{GPF} . The arc ignites and the previously set ignition current \overline{ISt} flows.
- ④ The main current phase \overline{I} ends when the set \overline{EP} spot time elapses.
- ⑤ For long-time spot welding only (parameter $\overline{SES} = \overline{OFF}$):
The welding current decreases to the end-crater current \overline{IEd} within the set down-slope time \overline{Edn} .
- ⑥ The gas post-flow time \overline{GPE} elapses and the welding process ends.

Press and release the torch trigger (tap) to reactivate the welding process (only for separate process activation). Touching the welding torch with the tungsten electrode tip against the workpiece again will initiate the next welding processes.

4.1.6 TIG activArc welding

The EWM activArc process, thanks to the highly dynamic controller system, ensures that the power supplied is kept virtually constant in the event of changes in the distance between the welding torch and the weld pool, e.g. during manual welding. Voltage losses as a result of a shortening of the distance between the torch and molten pool are compensated by a current rise (ampere per volt - A/V), and vice versa. This helps prevent the tungsten electrode sticking in the molten pool and the tungsten inclusions are reduced.

Selection

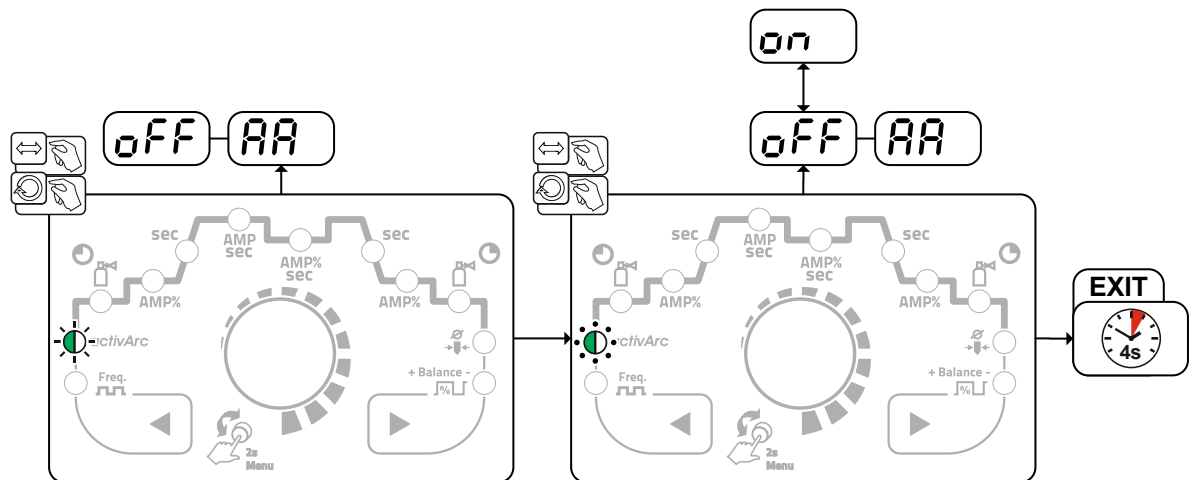

Figure 4-18

Setting

Parameter setting

The activArc parameter (control) can be adjusted specifically for the welding task (panel thickness) > see 4.1.10 chapter.

4.1.7 TIG antistick

The function prevents uncontrolled re-ignition following the sticking of the tungsten electrode in the weld pool by switching off the welding current. In addition, wear at the tungsten electrode is reduced.

After triggering the function the machine immediately switches to the gas post-flow process phase. The welder starts the new process again at the first cycle. The user can switch the function on or off (parameter \overline{EAS}) > see 4.6 chapter.

4.1.8 Pulse welding

The following pulse types can be selected:

- Automated pulsing (TIG DC)
- Thermal pulsing (TIG AC or TIG DC)
- Metallurgical pulsing (TIG DC)
- Average value pulses
- AC special (TIG AC)

4.1.8.1 Automated pulses

The automated pulsing pulse variant is only activated for DC welding in combination with the spotArc operating mode. The current-dependent pulse frequency and balance create vibrations in the weld pool that have a positive effect on the gap bridging. The required pulse parameters are automatically defined by the machine control. If required, the function can be disabled by pressing the pulsed welding push-button.

Selection

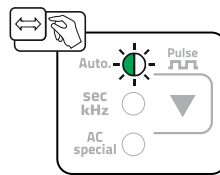

Figure 4-19

4.1.8.2 Thermal pulsing

The operation sequences basically match the standard welding sequences, but there is an additional switching back and forth between the main current AMP (pulse current) and the secondary current AMP% (pulse pause current) at the set times. Pulse and pause times are entered in seconds.

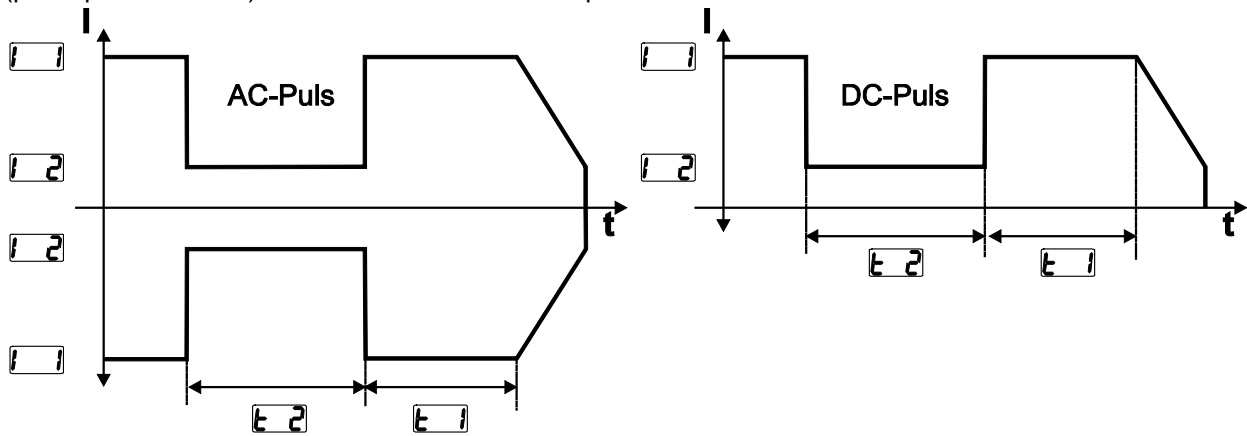

Figure 4-20

Selection

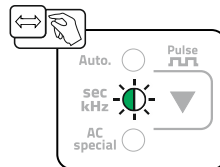

Figure 4-21

Pulse time setting

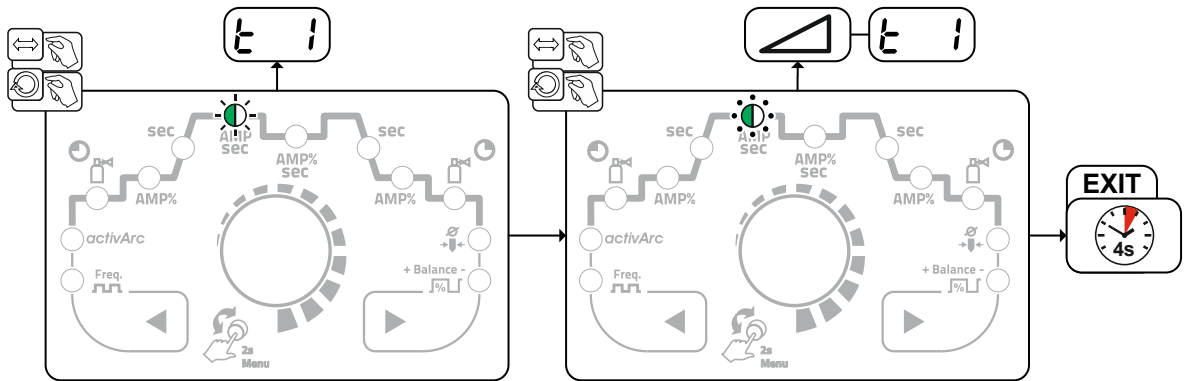

Figure 4-22

Pulse pause setting

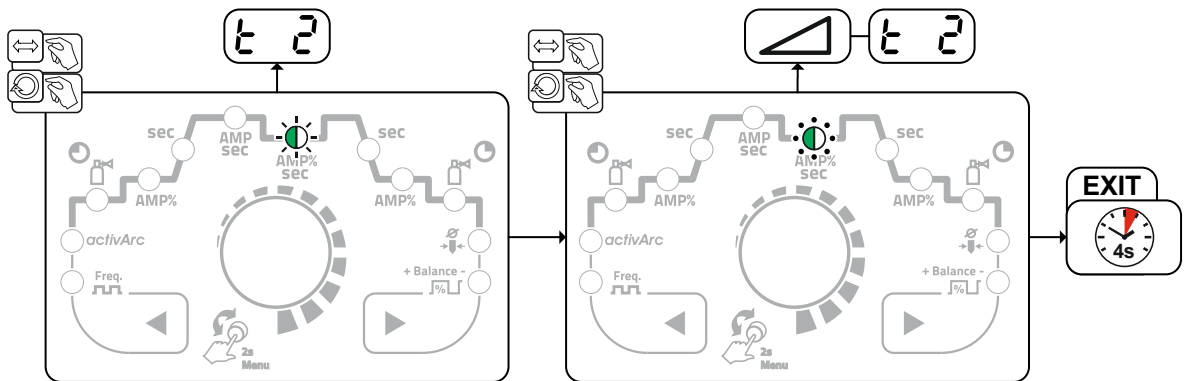

Figure 4-23

Pulse edge setting

4.1.8.3 Pulsed welding in the upslope and downslope phases

The pulse function can also be deactivated if necessary during the up-slope and down-slope phases (parameter \overline{PSL}) > see 4.6 chapter.

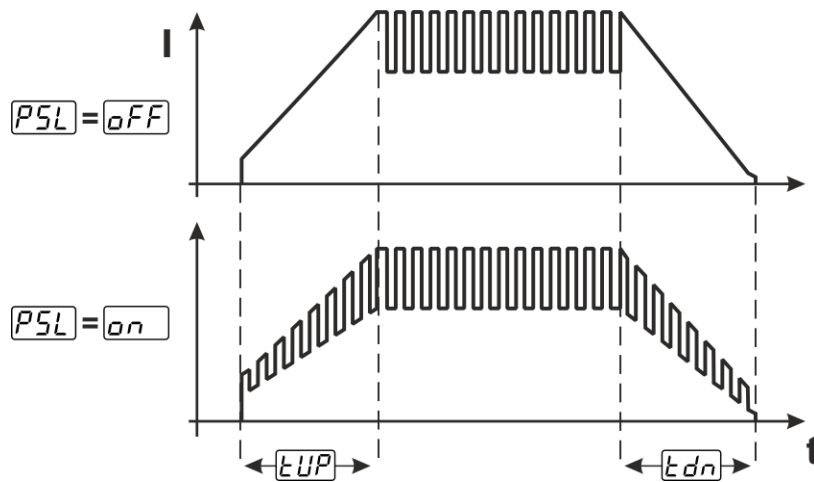

Figure 4-24

4.1.8.4 Average value pulse welding

A special feature with average value pulses is that the power source will always maintain the preset average value. This makes this method especially suitable for welding according to welding procedure specifications.

The parameter \overline{PRU} must be switched to \overline{on} in the machine configuration menu to enable this pulse variant. Once the function is activated, the red signal lights for the main current AMP and secondary current AMP% light up at the same time.

Average value pulse welding means that the system switches between two currents periodically, an average current value (AMP), a pulse current (I_{puls}), a balance (\overline{bRL}) and a frequency (\overline{FrE}) having been defined first. The predefined ampere current average value is decisive, the pulse current (I_{puls}) is defined by the \overline{IPL} parameter as a percentage of the average current value (AMP).

The pulse pause current (IPP) is not set; the machine control calculates the value instead to ensure that the average value of the welding current (AMP) is maintained. For average value pulsing, the $\overline{I2}$ current is the secondary current only, activated with the torch trigger.

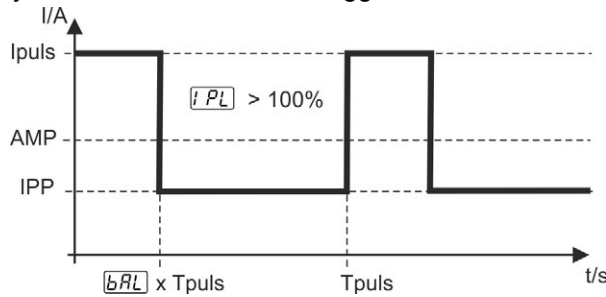

Figure 4-25

AMP = main current (average value), e.g. 100 A

I_{puls} = pulse current = $\overline{IPL} \times \text{AMP}$, e.g. 140% \times 100 A = 140 A

IPP = pulse pause current

T_{puls} = duration of one pulse cycle = $1/\overline{FrE}$, e.g. 1/100 Hz = 10 ms

\overline{bRL} = balance

4.1.8.5 Metallurgical pulsing (kHz pulsing)

Metallurgical pulsing (kHz pulsing) uses the plasma force (arc force) occurring at high currents which allows you to achieve a constricted arc with concentrated heat input. Unlike thermal pulsing, no times are set; a frequency \overline{FrE} and the balance \overline{bRL} are set instead. The pulsing process also occurs during the up-slope and down-slope phase.

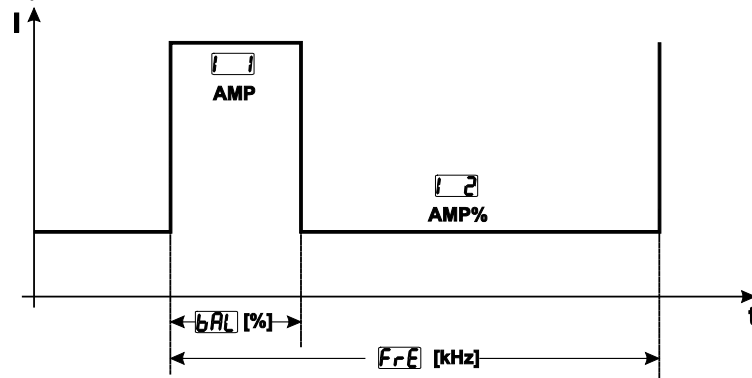

Figure 4-26

Selection

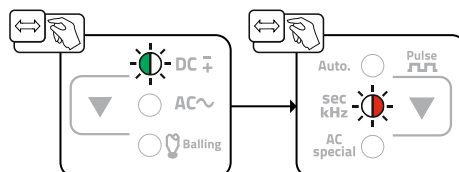

Figure 4-27

Balance setting

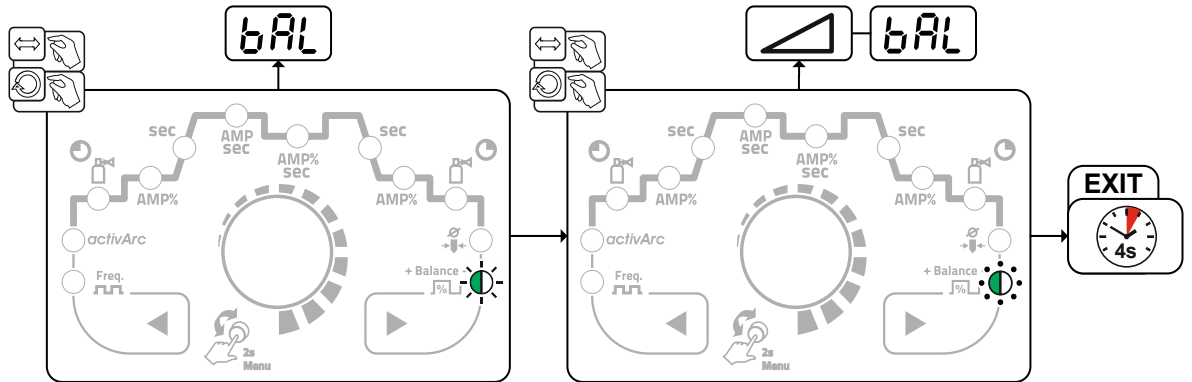

Figure 4-28

Frequency setting

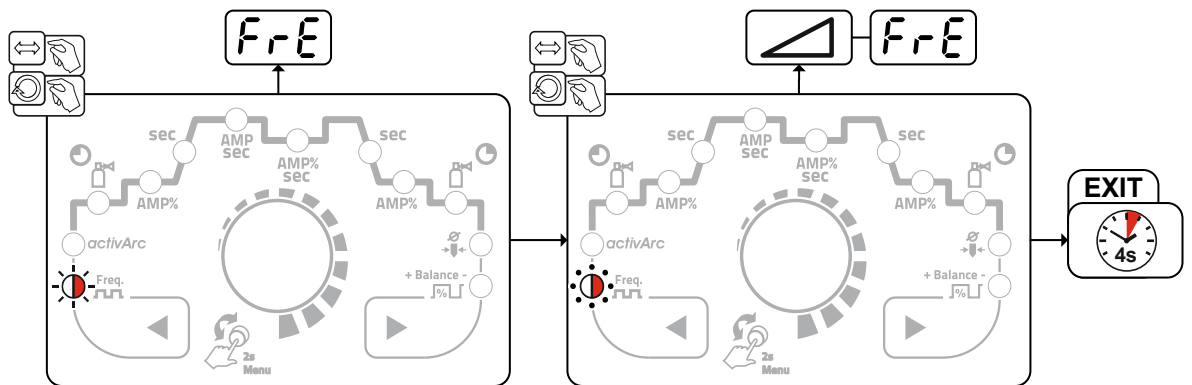

Figure 4-29

4.1.8.6 AC special

Is e.g. used to join metal sheets of different thickness.

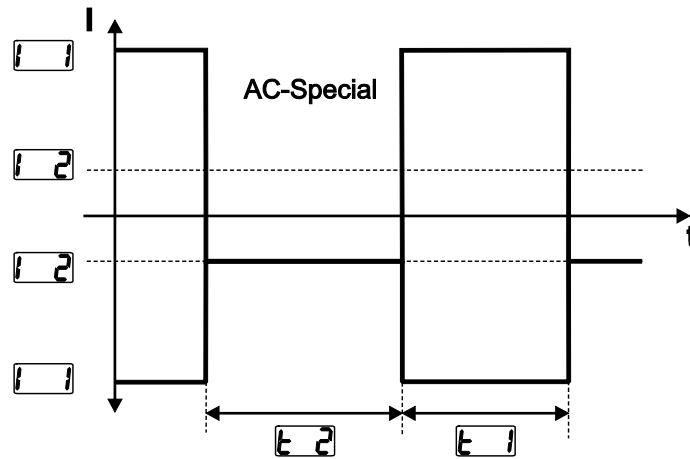

Figure 4-30

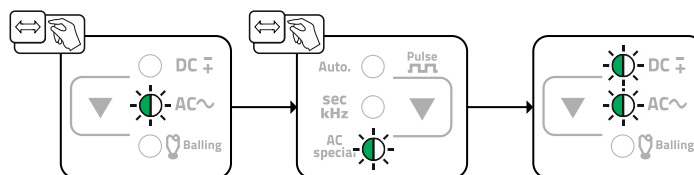

Figure 4-31

4.1.9 Welding torch (operating variants)

Different torch versions can be used with this machine.

Functions on the operating elements, such as torch triggers (BRT), rockers or potentiometers, can be modified individually via torch modes.

Explanation of symbols for operating elements:

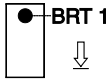
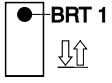
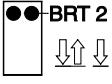
Symbol	Description
	Press torch trigger
	Tap torch trigger
	Tap and press torch trigger

4.1.9.1 Tapping function (tap torch trigger)

Tapping function: Swiftly tap the torch trigger to change the function. The set torch mode determines the operating mode.

4.1.9.2 Torch mode setting

Modes 1 to 4 and 11 to 14 are available to the user. Modes 11 to 14 feature the same functionality as 1 to 4, but without the tapping function > see 4.6 chapter for the secondary current.

The functionality of the individual modes can be found in the corresponding torch type tables.

The torch modes are set using the torch configuration parameters "Erd" in the machine configuration menu > torch mode "Eod".

 **Only the modes listed are suitable for the corresponding torch types.**

4.1.9.3 Up/down speed

Functionality

Press and hold the up push-button:

Increase current up to the maximum value (main current) set in the power source.

Press and hold the down push-button:

Decrease current to the minimum value.

Use the machine configuration menu > see 4.6 chapter to set the up/down speed parameter Ud which determines the speed with which a current change becomes effective.

4.1.9.4 Current jump

By tapping the corresponding torch trigger the welding current can be determined in an adjustable jump range. Each tap will cause the welding current to jump up or down by the defined value.

The "current jump" parameter dI is set in the machine configuration menu > see 4.6 chapter.

4.1.9.5 Standard TIG torch (5-pole)

Standard torch with one torch trigger

Figure	Operating elements	Explanation of symbols
		BRT1 = torch trigger 1 (welding current on/off; secondary current via tapping function)

Functions	Mode	Operating elements
Welding current on/off	1 (ex works)	
Secondary current (latched operation)		

Standard torch with two torch triggers

Figure	Operating elements	Explanation of symbols
		BRT1 = torch trigger 1 BRT2 = torch trigger 2

Functions	Mode	Operating elements
Welding current on/off	1 (ex works)	
Secondary current		
Secondary current (tapping function) ¹ /(latched operating mode)		
Welding current on/off	3	
Secondary current (tapping function) ¹ /(latched operating mode)		
Up function ²		
Down function ²		

¹ > see 4.1.9.1 chapter

² > see 4.1.9.3 chapter

³ > see 4.1.9.4 chapter

Standard torch with one rocker (rocker, two torch triggers)

Figure	Operating elements	Explanation of symbols
		BRT 1 = torch trigger 1 BRT 2 = torch trigger 2

Functions	Mode	Operating elements
Welding current on/off	1 (ex works)	
Secondary current		
Secondary current (tapping function ¹)/(latched operating mode)		
Welding current on/off	2	
Secondary current (tapping function ¹)		
Up function ²		
Down function ²		
Welding current on/off	3	
Secondary current (tapping function ¹)/(latched operating mode)		
Up function ²		
Down function ²		

¹ > see 4.1.9.1 chapter



² > see 4.1.9.3 chapter

³ > see 4.1.9.4 chapter

4.1.9.6 TIG up/down torch (8-pole)

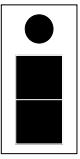
Up/down torch with one torch trigger

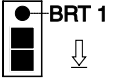
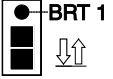
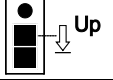
Figure	Operating elements	Explanation of symbols
		BRT 1 = torch trigger 1

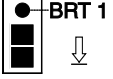
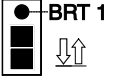
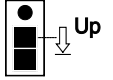
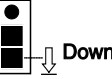
Functions	Mode	Operating elements
Welding current on/off	1 (ex works)	
Secondary current (tapping function ¹)/(latched operating mode)		
Increase welding current (up function ²)		
Decrease welding current (down function ²)		
Welding current on/off	4	
Secondary current (tapping function ¹)/(latched operating mode)		
Increase welding current via current jump ³		
Decrease welding current via current jump ³		

¹ > see 4.1.9.1 chapter

² > see 4.1.9.3 chapter

³ > see 4.1.9.4 chapter

Up/down torch with two torch triggers

Figure	Operating elements	Explanation of symbols
		BRT 1 = torch trigger 1 (left) BRT 2 = torch trigger 2 (right)

Functions	Mode	Operating elements
Welding current on/off	1 (ex works)	
Secondary current		
Secondary current (tapping function ¹)/(latched operating mode)		
Increase welding current (up function ²)		
Decrease welding current (down function ²)		

Modes 2 and 3 are not used with this type of torch or, respectively, are not appropriate.

Welding current on/off	4	
Secondary current		
Secondary current (tapping function ¹)		
Increase welding current via current jump ³		
Decrease welding current via current jump ³		
Gas test		

¹ > see 4.1.9.1 chapter

² > see 4.1.9.3 chapter

³ > see 4.1.9.4 chapter

4.1.9.7 Potentiometer torch (8-pole)



The welding machine needs to be configured for operation with a potentiometer torch > see 4.1.9.8 chapter.

Potentiometer torch with one torch trigger

Figure	Operating elements	Explanation of symbols
		BRT 1 = torch trigger 1

Functions	Mode	Operating elements
Welding current on/off	3	
Secondary current (tapping function ¹)		
Increase welding current		
Decrease welding current		

Potentiometer torch with two torch triggers

Figure	Operating elements	Explanation of symbols
		BRT 1 = torch trigger 1 BRT 2 = torch trigger 2

Functions	Mode	Operating elements
Welding current on/off	3	
Secondary current		
Secondary current (tapping function ¹)		
Increase welding current		
Decrease welding current		

¹ > see 4.1.9.1 chapter

4.1.9.8 Configuring the TIG potentiometer torch connection

⚠ DANGER



Risk of injury due to electrical voltage after switching off!
Working on an open machine can lead to fatal injuries!
Capacitors are loaded with electrical voltage during operation. Voltage remains present for up to four minutes after the mains plug is removed.

1. Switch off machine.
2. Remove the mains plug.
3. Wait for at last 4 minutes until the capacitors have discharged!

⚠ WARNING



Do not carry out any unauthorised repairs or modifications!
To avoid injury and equipment damage, the unit must only be repaired or modified by specialist, skilled persons!

The warranty becomes null and void in the event of unauthorised interference.

- Appoint only skilled persons for repair work (trained service personnel)!

Before reconnection, "Inspection and Testing during Operation" according to IEC/BS EN 60974-4 "Arc welding systems – Inspection and Testing during Operation" has to be performed!

When connecting a potentiometer torch, jumper JP1 on PCB T200/1 inside the welding machine should be unplugged.

Welding torch configuration	Setting
Prepared for TIG standard or up/down torch (factory setting)	<input checked="" type="checkbox"/> JP1
Prepared for potentiometer torches	<input type="checkbox"/> JP1

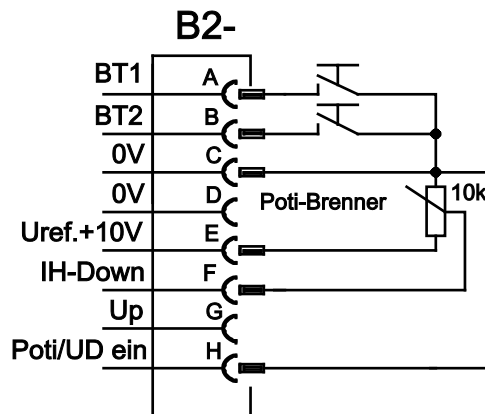

Figure 4-32

This torch type requires the welding machine to be set to torch mode 3 > see 4.1.9.2 chapter.

4.1.9.9 RETOX TIG torch (12-pole)

For operation with this welding torch, the welding machine must be equipped with the retrofit option "ON 12POL RETOX TIG" (12-pole torch connection socket)!

Diagram	Operating elements	Explanation of symbols
		TT= torch trigger

Functions	Mode	Operating elements
Welding current on/off	1 (ex works)	TT 1
Secondary current		TT 2
Secondary current (tapping function)		TT 1 (tapping)
Increase welding current (up function)		TT 3
Reduce welding current (down function)		TT 4
Welding current on/off	2	TT 1
Secondary current		TT 2
Secondary current (tapping function)		TT 1 (tapping)
Welding current on/off	3	TT 1
Secondary current		TT 2
Secondary current (tapping function)		TT 1 (tapping)
Welding current on/off	4	TT 1
Secondary current		TT 2
Secondary current (tapping function)		TT 1 (tapping)
Increase welding current (up function)		TT 3
Reduce welding current (down function)		TT 4

4.1.10 Expert menu (TIG)

The Expert menu has adjustable parameters stored that don't require regular setting. The number of parameters shown may be limited, e.g. if a function is deactivated.

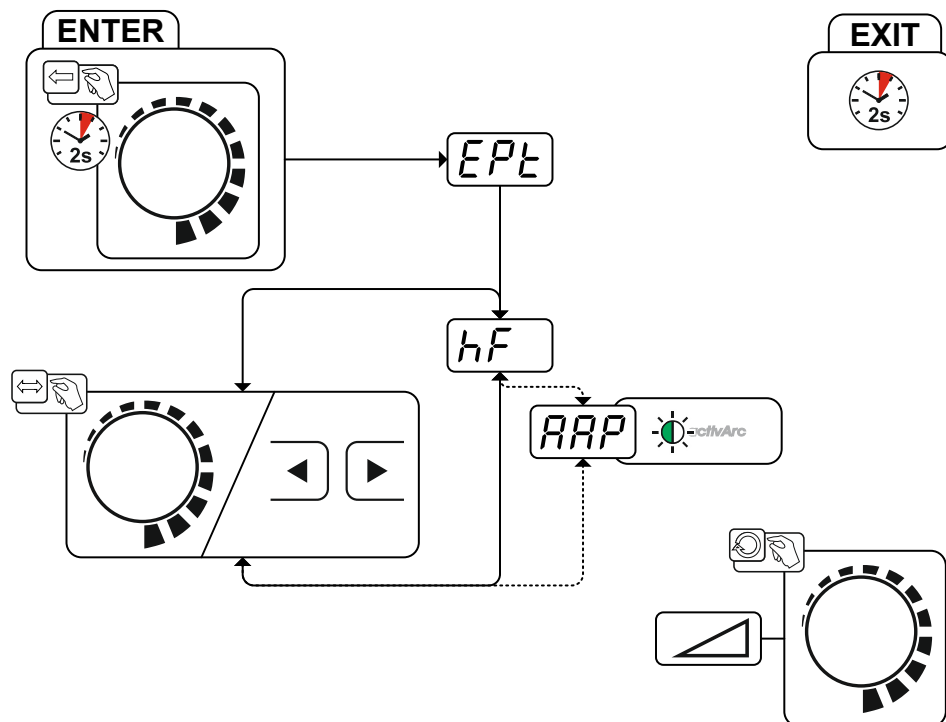

Figure 4-33

Display	Setting/selection
	activArc parameter Parameter also adjustable after TIG activArc welding is activated.
	Ignition type (TIG) <input type="checkbox"/> on ----- HF start active (ex works) <input type="checkbox"/> oFF ----- Lift arc ignition active

4.2 MMA welding

4.2.1 Welding task selection

It is only possible to change the basic parameters when no welding current is flowing and any possible access control is disabled > see 4.4 chapter.

The following welding task selection is an example of use. In general, the selection process always has the same sequence. Signal lights (LED) will show the selected combination.

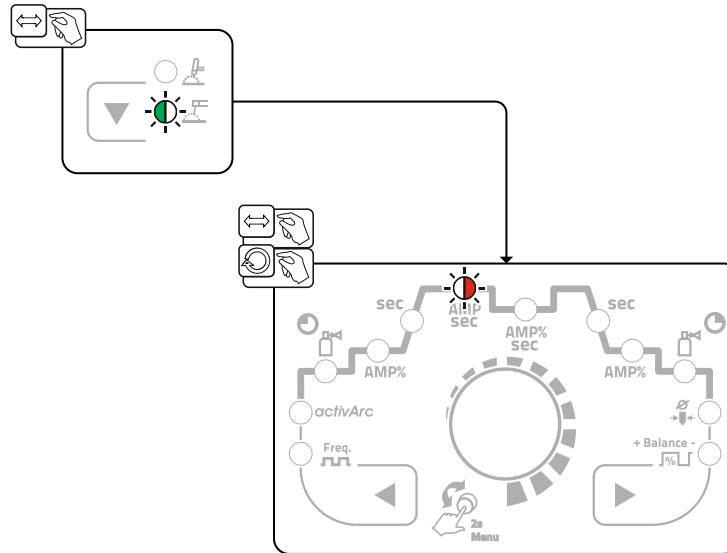
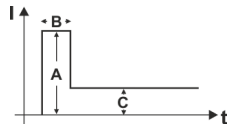

Figure 4-34

4.2.2 Hotstart

The hot start function improves the arc striking.

After striking the stick electrode, the arc ignites at the increased hot start current and decreases to the set main current once the hot start time has elapsed.



A = Hot start current
 B = Hot start time
 C = Main current
 I = Current
 t = Time

Figure 4-35

4.2.2.1 Hotstart current

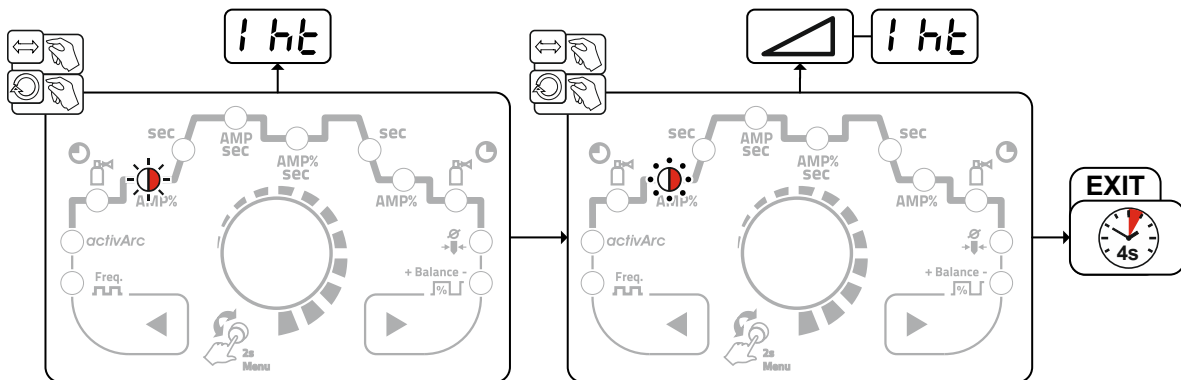

Figure 4-36

4.2.2.2 Hotstart time

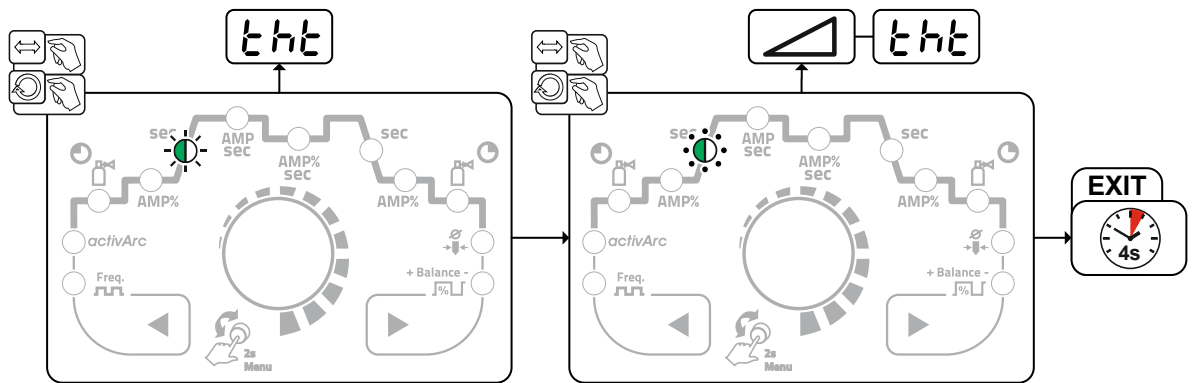
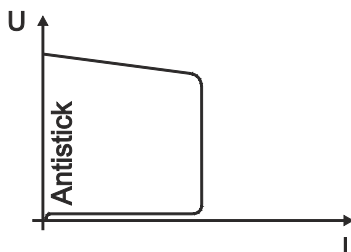

Figure 4-37

4.2.3 Antistick



The Antistick feature prevents the electrode from annealing. Should the electrode stick, the machine automatically switches to the minimum current within approx. one second. This prevents the electrode from annealing. Check the welding current setting and correct for the welding task in hand.

Figure 4-38

4.2.4 Welding current polarity reversal (polarity reversal)

This function can be used to reverse the welding current polarity electronically. For example, when welding with different electrode types for which different polarities are stipulated by the manufacturer, the welding current polarity can be switched easily on the control.

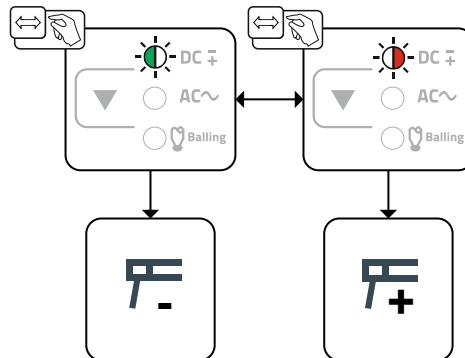

Figure 4-39

Not available for machines with voltage reduction device (VRD).

4.2.5 Average value pulse welding

With average value pulsing, two currents are periodically toggled. The user can adjust the welding current (average current value AMP), pulse current I_{puls} (parameter I_{PL}), balance bAL and frequency FrE to the welding task. The pulse pause current (IPP) is calculated by the machine control, so that the welding current average value (AMP) is maintained and shown. This makes this method especially suitable for welding according to welding procedure specifications.

Average value pulse welding means that two currents are switched periodically, a current average value (AMP), a pulse current (I_{puls}), a balance (bAL) and a frequency (FrE) having been defined first. The predefined ampere current average value is decisive, the pulse current (I_{puls}) is defined by the I_{PL} parameter as a percentage of the current average value (AMP). The pulse pause current (IPP) requires no setting. This value is calculated by the machine control, so that the welding current average value (AMP) is maintained at all times.

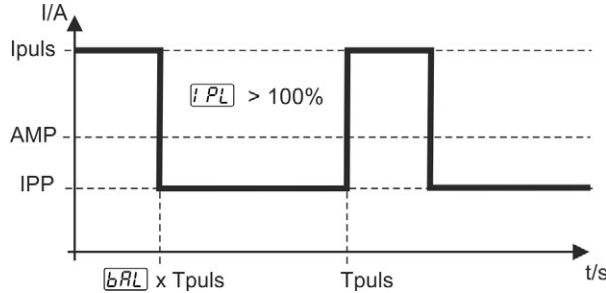

Figure 4-40

AMP = Main current; e.g. 100 A

I_{PL} = Pulse current = $I_{PL} \times AMP$; e.g. 170% x 100 A = 170 A

IPP = Pulse pause current

T_{puls} = Duration of one pulse cycle = $1/FrE$; e.g. $1/1 \text{ Hz} = 1 \text{ s}$

bAL = Balance

Selection

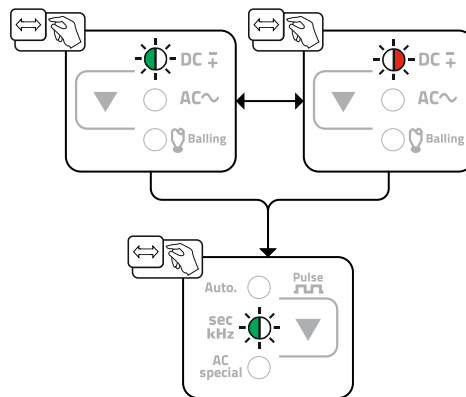
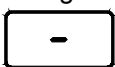

Figure 4-41

4.3 Power-saving mode (Standby)

You can activate the power-saving mode by either pressing the push-button > see 3 chapter for a prolonged time or by setting a parameter in the machine configuration menu (time-controlled power-saving mode bAL) > see 4.6 chapter.



When power-saving mode is activated, the machine displays show the horizontal digit in the centre of the display only.

Pressing any operating element (e.g. turning a rotary knob) deactivates power-saving mode and the machine is ready for welding again.

4.4 Access control

The machine control can be locked to secure it against unauthorised or unintentional adjustment. The access block has the following effect:

- The parameters and their settings in the machine configuration menu, Expert menu and operation sequence can only be viewed but not changed.
- Welding procedure and welding current polarity cannot be changed.

The parameters for the access block are configured in the machine configuration menu > see 4.6 chapter.

Enabling the access block

- Enter the access code for the access block: select the **UoL** menu and enter the valid numerical code (0–999).
- Enable access block: Set parameter to **on**.

Disabling the access block

- Enter the access code for the access block: Select the **UoL** menu and enter the numerical code (0–999).
- Disable access block: Set parameter to **off**.

The only way to disable the access block is to enter the selected numerical code.

Changing the access block

- Enter the access code for the access block: Select the **cod** menu and enter the numerical code (0–999).
- Change the access block: Once the display shows **nEe**, assign a new numerical code (0–999).
- If the entry is incorrect, the display shows **Err**.

The factory setting for the code is **000**.

4.5 Voltage reducing device

Only machine variants with the (VRD/AUS/RU) code are equipped with a voltage reduction device (VRD). The VRD is used for increased safety, especially in hazardous environments such as shipbuilding, pipe construction or mining.

A VRD is mandatory in some countries and required by many on-site safety instructions for power sources.

The VRD > see 3 chapter signal light is illuminated when the voltage reduction device is operating without fault and the output voltage is reduced to a value specified in the relevant standard (see technical data).

4.6 Machine configuration menu

Basic machine settings are defined in the machine configuration menu.

4.6.1 Selecting, changing and saving parameters

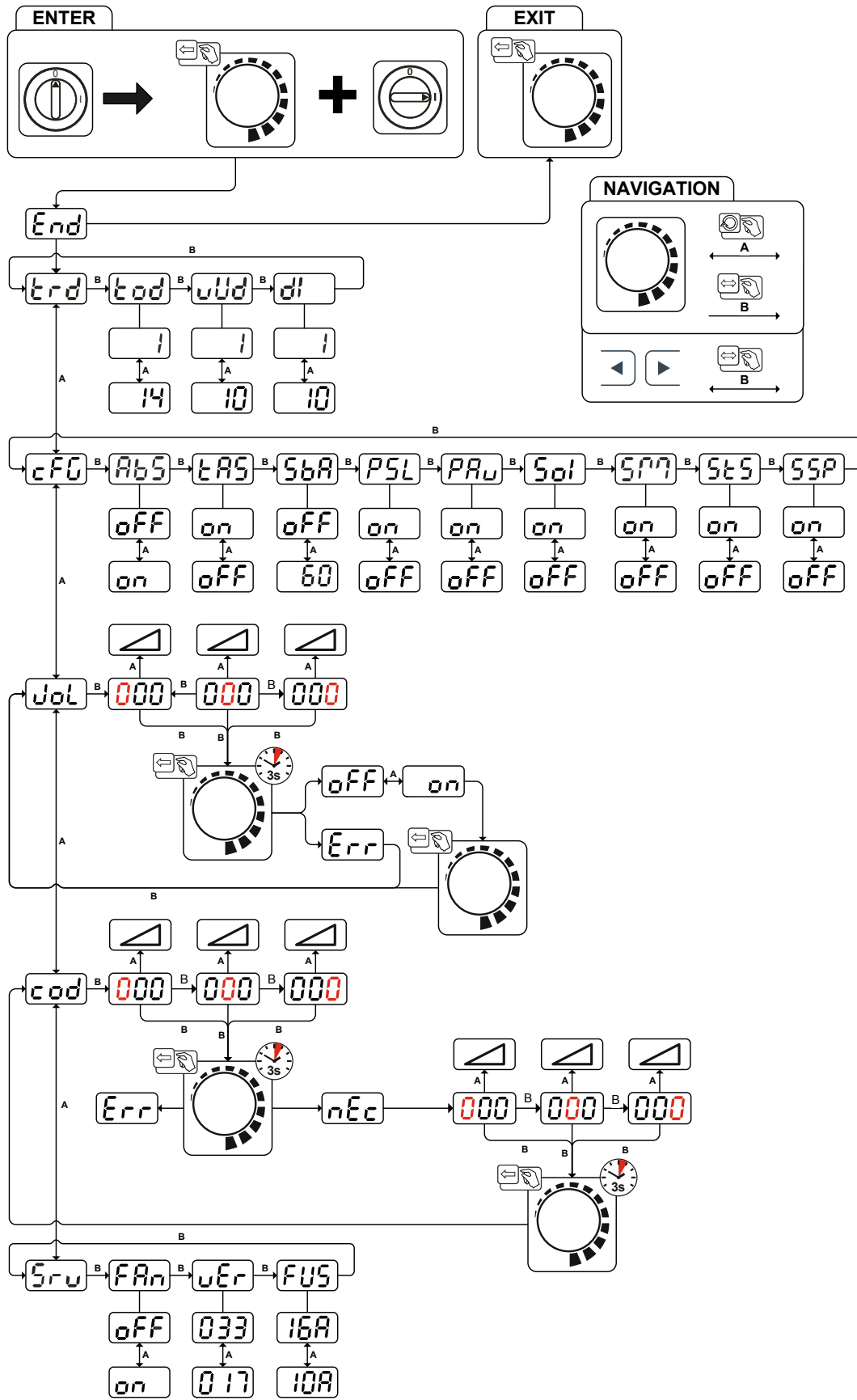















Figure 4-42

Display	Setting/selection
End	Exit the menu Exit
trd	Torch configuration menu Set welding torch functions
tod	Torch mode (ex works 1) > see 4.1.9.2 chapter
uud	Up/down speed > see 4.1.9.3 chapter Increase value > rapid current change Decrease value > slow current change
di	Current jump > see 4.1.9.4 chapter Current jump setting in ampere
cFG	Machine configuration Settings for machine functions and parameter display
AbS	Absolute value setting (ignition, secondary, end and hot start current) > see 3.2.1 chapter on -----Welding current setting, absolute oFF -----Welding current setting, as a percentage of the main current (ex works)
TA5	TIG antistick > see 4.1.7 chapter on -----function active (factory setting). oFF -----function inactive.
5bA	Time-based power-saving mode > see 4.3 chapter Time to activation of the power-saving mode in case of inactivity. Setting oFF = disabled or numerical value 5– 60 min. (ex works: 20).
PSL	Pulsed TIG welding (thermic) in the upslope and downslope phases > see 4.1.8.3 chapter on -----Function enabled (ex works) oFF -----Function disabled
PAu	TIG average value pulsing on -----Average value pulsing enabled oFF -----Average value pulsing disabled (ex works)
5oI	TIG HF start (soft/hard) switching on -----soft ignition (factory setting). oFF -----hard ignition.
5Pn	spotmatic operating mode > see 4.1.5.5 chapter Ignition by contact with the workpiece on -----Function enabled (ex works) oFF -----Function disabled
5tS	Spot time setting > see 4.1.5.5 chapter on -----Short spot time, setting range 5 ms to 999 ms, increments of 1 ms (ex works) oFF -----Long spot time, setting range 0.01 s to 20.0 s, increments of 10 ms (ex works)
5SP	Process activation setting > see 4.1.5.5 chapter on -----Separate process activation (ex works) oFF -----Permanent process activation
JoL	Access block menu Protect welding parameters against unauthorised access.
000	Machine code Querying the three-digit machine code (000 to 999), user input
oFF	Switch off Switching off machine function
on	Switch on Switching on machine function

	Error Error message after entering an incorrect machine code
	Access control – access code Setting: 000 to 999 (000 ex works)
	Machine code Querying the three-digit machine code (000 to 999), user input
	Error Error message after entering an incorrect machine code
	New machine code <ul style="list-style-type: none"> • Machine code entered correctly • Prompt for entering the new machine code
	Machine code Querying the three-digit machine code (000 to 999), user input
	Service menu Any changes to the service menu should be agreed with the authorised service personnel.
	Functional test for machine fans  ----- Machine fans enabled  ----- Machine fans disabled
	Software version of the machine control Rotary transducer on the left: software version 1 Rotary transducer on the right: software version 2
	Dynamic power adjustment
	Numerical value – adjustable

5 Rectifying faults

All products are subject to rigorous production checks and final checks. If, despite this, something fails to work at any time, please check the product using the following flowchart. If none of the fault rectification procedures described leads to the correct functioning of the product, please inform your authorised dealer.

5.1 Error messages (power source)

 **A welding machine error is indicated by an error code being displayed (see table) on the display on the machine control.**

In the event of a machine error, the power unit is shut down.

 **The display of possible error numbers depends on the machine version (interfaces/functions).**

- Document machine errors and inform service staff as necessary.

Error message	Possible cause	Remedy
Err 1	Water fault Only occurs if a water cooling unit is connected.	Ensure that sufficient water pressure can be built up. (e.g. top up water)
Err 2	Temperature error	Allow machine to cool down.
Err 3	Electronics error	Switch machine off and on again. If the fault persists, inform the service department.
Err 4	see "Err 3"	see "Err 3"
Err 5	see "Err 3"	see "Err 3"
Err 6	Balancing error in voltage recording.	Switch machine off, place the torch on an insulated surface and switch on again. If the fault persists, inform the service department.
Err 7	Balancing error in current recording.	Switch machine off, place the torch on an insulated surface and switch on again. If the fault persists, inform the service department.
Err 8	Error in one of the electronics supply voltages or excess temperature of the welding transformer.	Allow machine to cool down. If the error message persists, switch the machine off and back on again. If the fault persists, inform the service department.
Err 9	Low voltage	Switch off the machine and check the mains voltage.
Err 10	Secondary overvoltage	Switch machine off and on again. If the fault persists, inform the service department.
Err 11	Overvoltage	Switch off the machine and check the mains voltage.
Err 12	VRD (open circuit voltage reduction error)	Inform Service

5.2 Dynamic power adjustment

 **This requires use of the appropriate mains fuse.
Observe mains fuse specification!**

This function enables aligning the machine to the mains connection fusing to avoid continuous tripping of the mains fuse. The maximum power input of the machine is limited by an exemplary value for the existing mains fuse (several levels available).

You can predefine this value in the machine configuration menu using parameter **FUS**. The function automatically adjusts the welding power to an uncritical level for the mains fuse.

5.3 Resetting welding parameters to the factory settings

All customised welding parameters that are stored will be replaced by the factory settings.

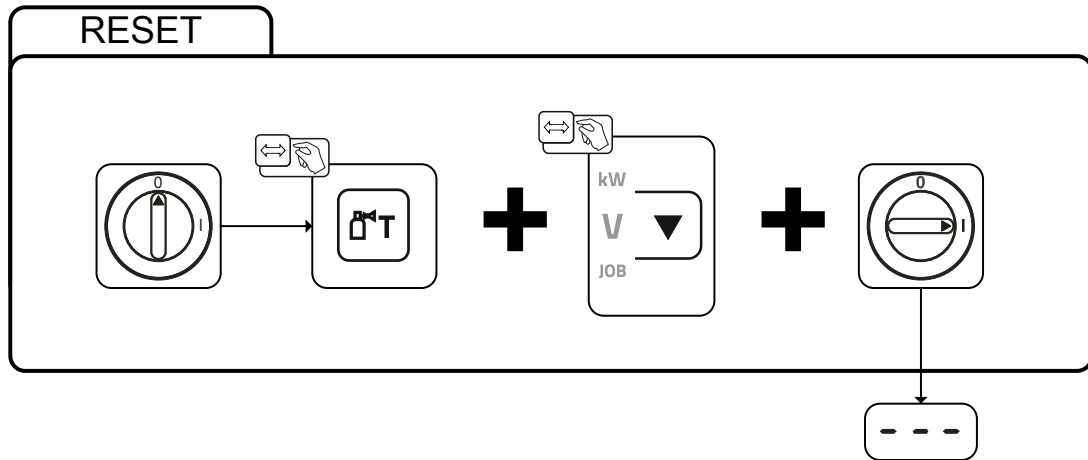

Figure 5-1

Display	Setting/selection
	Input confirmation User entries are applied, release button(s).

5.4 Display machine control software version

The query of the software versions only serves to inform the authorised service staff. It is available in the machine configuration menu > see 4.6 chapter.

6 Appendix A

6.1 Parameter overview – setting ranges

6.1.1 TIG welding

Name	Display			Setting range	
	Code	Standard	Unit	Min.	Max.
Main current AMP, depending on power source	I 1	-	A	-	-
Gas pre-flow time	GPr	0,5	s	0	20
Ignition current, percentage of AMP	I 5t	20	%	1	200
Ignition current, absolute, depending on power source	I 5t	-	A	-	-
Up-slope time	tUP	1,0	s	0,0	20,0
Pulse current	I PL	140	%	1	200
Pulse time	t 1	0,01	s	0,00	20,0
Secondary current, percentage of AMP	I 2	50	%	1	200
Secondary current, absolute, depending on power source	I 2	-	A	-	-
Pulse pause time	t 2	0,01	s	0,00	20,0
Down-slope time	t dn	1,0	s	0,0	20,0
End current, percentage of AMP	I Ed	20	%	1	200
End current, absolute, depending on power source	I Ed	-	A	-	-
Gas post-flow time	GPE	8	s	0,0	40,0
Electrode diameter, metric	ndR	2,4	mm	1,0	4,0
spotArc time	t P	2	s	0,01	20,0
spotmatic time ($\overline{5t5} > \overline{on}$)	t P	200	ms	5	999
spotmatic time ($\overline{5t5} > \overline{OFF}$)	t P	2	s	0,01	20,0
AC balance (JOB 0) ¹	bAL		%	-30	+30
AC balance (JOB 1-7) ¹	bAL		%	1	99
Pulse balance	bAL		%	1	99
Pulse frequency	FrE	50	Hz	5	2500
AC frequency ¹	FrE	-	Hz	50	200
activArc	RAp			0	100
Dynamic power adjustment	FUS	16	A	10	16

¹ for AC welding machines only.

6.1.2 MMA welding

Name	Display			Setting range	
	Code	Standard	Unit	Min.	Max.
Main current AMP, depending on power source	<input type="text" value="I I"/>	-	A	-	-
Hot start current, percentage of AMP	<input type="text" value="I hE"/>	120	%	1	200
Hot start current, absolute, depending on power source	<input type="text" value="I hE"/>	-	A	-	-
Hot start time	<input type="text" value="E hE"/>	0,5	s	0,0	10,0
Pulse current	<input type="text" value="I PL"/>	142		1	200
Pulse frequency	<input type="text" value="FrE"/>	1,2	Hz	0,2	50
Pulse balance	<input type="text" value="bRL"/>	30		1	99
Dynamic power adjustment	<input type="text" value="FUS"/>	16	A	10	16

7 Appendix B

7.1 Overview of EWM branches

Headquarters

EWM AG
Dr. Günter-Henle-Straße 8
56271 Mündersbach · Germany
Tel: +49 2680 181-0 · Fax: -244
www.ewm-group.com · info@ewm-group.com

Technology centre

EWM AG
Forststraße 7-13
56271 Mündersbach · Germany
Tel: +49 2680 181-0 · Fax: -144
www.ewm-group.com · info@ewm-group.com

Production, Sales and Service

EWM AG
Dr. Günter-Henle-Straße 8
56271 Mündersbach · Germany
Tel: +49 2680 181-0 · Fax: -244
www.ewm-group.com · info@ewm-group.com

EWM HIGH TECHNOLOGY (Kunshan) Ltd.
10 Yuanshan Road, Kunshan · New & Hi-tech Industry Development Zone
Kunshan City · Jiangsu · Post code 215300 · People's Republic of China
Tel: +86 512 57867-188 · Fax: -182
www.ewm.cn · info@ewm.cn · info@ewm-group.cn

EWM HIGHTEC WELDING s.r.o.
9. května 718 / 31
407 53 Jiřikov · Czech Republic
Tel: +420 412 358-551 · Fax: -504
www.ewm-jirikov.cz · info@ewm-jirikov.cz

Sales and Service Germany

EWM AG - Rathenow branch
Sales and Technology Centre
Grünauer Fenn 4
14712 Rathenow · Tel: +49 3385 49402-0 · Fax: -20
www.ewm-rathenow.de · info@ewm-rathenow.de

EWM AG - Göttingen branch
Rudolf-Winkel-Straße 7-9
37079 Göttingen · Tel: +49 551-3070713-0 · Fax: -20
www.ewm-goettingen.de · info@ewm-goettingen.de

EWM AG - Pulheim branch
Dieselstraße 9b
50259 Pulheim · Tel: +49 2238-46466-0 · Fax: -14
www.ewm-pulheim.de · info@ewm-pulheim.de

EWM AG - Koblenz branch
August-Horch-Straße 13a
56070 Koblenz · Tel: +49 261 963754-0 · Fax: -10
www.ewm-koblenz.de · info@ewm-koblenz.de

EWM AG - Siegen branch
Eiserfelder Straße 300
57080 Siegen · Tel: +49 271 3878103-0 · Fax: -9
www.ewm-siegen.de · info@ewm-siegen.de

EWM AG - München Region branch
Gadastraße 18a
85232 Bergkirchen · Tel: +49 8142 284584-0 · Fax: -9
www.ewm-muenchen.de · info@ewm-muenchen.de

EWM AG - Tett nang branch
Karlsdorfer Straße 43
88069 Tett nang · Tel: +49 7542 97998-0 · Fax: -29
www.ewm-tett nang.de · info@ewm-tett nang.de

EWM AG - Neu-Ulm branch
Heinkelstraße 8
89231 Neu-Ulm · Tel: +49 731 7047939-0 · Fax: -15
www.ewm-neu-ulm.de · info@ewm-neu-ulm.de

EWM Schweißfachhandels GmbH
Dr. Günter-Henle-Straße 8 · 56271 Mündersbach
St. Augustin branch
Am Apfelbäumchen 6-8
53757 St. Augustin · Tel: +49 2241 1491-530 · Fax: -549
www.ewm-sankt-augustin.de · info@ewm-sankt-augustin.de

Sales and Service International

EWM HIGH TECHNOLOGY (Kunshan) Ltd.
10 Yuanshan Road, Kunshan · New & Hi-tech Industry Development Zone
Kunshan City · Jiangsu · Post code 215300 · People's Republic of China
Tel: +86 512 57867-188 · Fax: -182
www.ewm.cn · info@ewm.cn · info@ewm-group.cn

EWM HIGHTEC WELDING GmbH
Wiesenstraße 27b
4812 Pinsdorf · Austria · Tel: +43 7612 778 02-0 · Fax: -20
www.ewm-austria.at · info@ewm-austria.at

EWM KAYNAK SİSTEMLERİ TİC. LTD. ŞTİ.
Orhangazi Mah. Mimsan San. Sit. 1714. Sok. 22/B blok No:12-14
34538 Esenyurt · İstanbul · Turkey
Tel: +90 212 494 32 19
www.ewm.com.tr · turkey@ewm-group.com

EWM HIGHTEC WELDING UK Ltd.
Unit 2B Coopies Way · Coopies Lane Industrial Estate
Morpeth · Northumberland · NE61 6JN · Great Britain
Tel: +44 1670 505875 · Fax: -514305
www.ewm-morpeth.co.uk · info@ewm-morpeth.co.uk

EWM HIGHTEC WELDING s.r.o.
Benešov branch
Prodejní a poradenské centrum Tyršova 2106
256 01 Benešov u Prahy · Czech Republic
Tel: +420 317 729-517 · Fax: -712
www.ewm-benesov.cz · info@ewm-benesov.cz

