



Welding machine

Taurus 355 Synergic S LP MM TKM

099-005421-EW501

Observe additional system documents!

12.05.2016

**Register now
and benefit!
Jetzt Registrieren
und Profitieren!**

www.ewm-group.com



General instructions

WARNING



Read the operating instructions!

The operating instructions provide an introduction to the safe use of the products.

- Read and observe the operating instructions for all system components, especially the safety instructions and warning notices!
- Observe the accident prevention regulations and any regional regulations!
- The operating instructions must be kept at the site of operation.
- Safety and warning labels at the machine indicate any possible risks. Keep these labels clean and legible at all times.
- The machine has been constructed to the state of the art and any regulations and standards applicable. It may be operated, serviced and repaired by trained personnel only.



In the event of queries on installation, commissioning, operation or special conditions at the installation site, or on usage, please contact your sales partner or our customer service department on +49 2680 181-0.

A list of authorised sales partners can be found at www.ewm-group.com.

Liability relating to the operation of this equipment is restricted solely to the function of the equipment. No other form of liability, regardless of type, shall be accepted. This exclusion of liability shall be deemed accepted by the user on commissioning the equipment.

The manufacturer is unable to monitor whether or not these instructions or the conditions and methods are observed during installation, operation, usage and maintenance of the equipment.

An incorrectly performed installation can result in material damage and injure persons as a result. For this reason, we do not accept any responsibility or liability for losses, damages or costs arising from incorrect installation, improper operation or incorrect usage and maintenance or any actions connected to this in any way.

© **EWM AG**

Dr. Günter-Henle-Str. 8

D-56271 Mündersbach, Germany

The copyright to this document remains the property of the manufacturer.

Reprinting, including extracts, only permitted with written approval.

The content of this document has been prepared and reviewed with all reasonable care. The information provided is subject to change, errors excepted.

1 Contents

1	Contents	3
2	Safety instructions	6
2.1	Notes on the use of these operating instructions	6
2.2	Explanation of icons.....	7
2.3	General	8
2.4	Transport and installation	12
2.4.1	Ambient conditions	13
2.4.1.1	In operation	13
2.4.1.2	Transport and storage.....	13
3	Intended use	14
3.1	Applications.....	14
3.2	Documents which also apply	15
3.2.1	Warranty	15
3.2.2	Declaration of Conformity.....	15
3.2.3	Welding in environments with increased electrical hazards.....	15
3.2.4	Service documents (spare parts and circuit diagrams).....	15
3.2.5	Calibration/Validation	15
4	Machine description – quick overview	16
4.1	Front view	16
4.2	Rear view	18
4.2.1	Operating elements in the machine.....	20
4.3	Machine control – Operating elements.....	22
5	Design and function	24
5.1	General	24
5.2	Installation.....	25
5.2.1	Protective flap, welding machine control.....	26
5.2.2	Welding torch holder	27
5.3	Machine cooling.....	28
5.4	Workpiece lead, general	28
5.5	Notes on the installation of welding current leads	28
5.6	Mains connection.....	30
5.6.1	Mains configuration	30
5.7	Welding torch cooling system	31
5.7.1	Welding torch cooling unit connection.....	31
5.8	Shielding gas supply (shielding gas cylinder for welding machine).....	32
5.8.1	Gas test	33
5.8.2	Rinse hose package function	33
5.8.3	Gas test – setting the shielding gas volume.....	33
5.9	Welding data display.....	34
5.10	MIG/MAG welding.....	35
5.10.1	Welding torch and workpiece line connection	35
5.10.2	Wire feed	37
5.10.2.1	Open the protective flap of the wire feeder	37
5.10.2.2	Inserting the wire spool	37
5.10.2.3	Changing the wire feed rollers	38
5.10.2.4	Inching the wire electrode	40
5.10.2.5	Spool brake setting	42
5.10.3	Definition of MIG/MAG welding tasks.....	43
5.10.4	Welding task selection.....	43
5.10.4.1	Basic welding parameters.....	43
5.10.4.2	Operating mode	43
5.10.4.3	Choke effect / dynamics.....	44
5.10.5	MIG/MAG operating point.....	45
5.10.5.1	Selecting the display unit	45
5.10.5.2	Operating point setting using material thickness	45
5.10.5.3	Arc length correction setting	46

5.10.5.4	Accessory components for operating point setting	46
5.10.5.5	forceArc	47
5.10.5.6	rootArc	48
5.10.6	MIG/MAG functional sequences / operating modes	49
5.10.6.1	Explanation of signs and functions	49
5.10.7	MIG/MAG program sequence ("Program steps" mode)	55
5.10.7.1	Example, tack welding (non-latched)	56
5.10.7.2	Example, aluminium tack welding (non-latched special)	56
5.10.7.3	Example, aluminium welding (latched special)	56
5.10.8	Main program A mode	57
5.10.9	MIG/MAG automatic cut-out	58
5.10.10	Standard MIG/MAG torch	59
5.10.11	MIG/MAG special-torches	59
5.10.11.1	Program- and Up- / down operation	59
5.10.11.2	Switching between Push/Pull and intermediate drive	59
5.11	TIG welding	60
5.11.1	Welding torch and workpiece line connection	60
5.11.2	Welding task selection	61
5.11.3	Welding current setting	61
5.11.4	TIG arc ignition	61
5.11.4.1	Liftarc	61
5.11.5	Function sequences/operating modes	62
5.11.5.1	Explanation of signs and functions	62
5.11.6	TIG automatic cut-out	65
5.12	MMA welding	66
5.12.1	Connecting the electrode holder and workpiece lead	66
5.12.2	Welding task selection	68
5.12.3	Welding current setting	68
5.12.4	Arcforce	68
5.12.5	Hotstart	68
5.12.6	Antistick	68
5.13	Remote control	69
5.14	Interfaces for automation	69
5.14.1	Remote control connection socket, 19-pole	70
5.15	PC Interfaces	71
5.16	Access control	71
5.17	Special parameters (advanced settings)	71
5.17.1	Selecting, changing and saving parameters	72
5.17.1.1	Reset to factory settings	74
5.17.1.2	Special parameters in detail	75
5.18	Machine configuration menu	85
5.18.1	Selecting, changing and saving parameters	85
5.18.2	Aligning the cable resistance	87
5.18.3	Power-saving mode (Standby)	88
6	Maintenance, care and disposal	89
6.1	General	89
6.2	Maintenance work, intervals	89
6.2.1	Daily maintenance tasks	89
6.2.1.1	Visual inspection	89
6.2.1.2	Functional test	89
6.2.2	Monthly maintenance tasks	90
6.2.2.1	Visual inspection	90
6.2.2.2	Functional test	90
6.2.3	Annual test (inspection and testing during operation)	90
6.3	Disposing of equipment	90
6.3.1	Manufacturer's declaration to the end user	90
6.4	Meeting the requirements of RoHS	90
7	Rectifying faults	91
7.1	Checklist for rectifying faults	91
7.2	Error messages (power source)	92

7.3	Resetting JOBs (welding tasks) to the factory settings	94
7.3.1	Resetting a single JOB	94
7.3.2	Resetting all JOBs	95
8	Technical data	96
8.1	Taurus 355 Synergic S	96
9	Accessories	97
9.1	General accessories	97
9.2	Remote control/connecting and extension cable	97
9.2.1	7-pole connection	97
9.2.2	19-pole connection	97
9.3	Options.....	98
9.4	Computer communication	98
10	Replaceable parts	99
10.1	Wire feed rollers.....	99
10.1.1	Wire feed rollers for steel wire.....	99
10.1.2	Wire feed rollers for aluminium wire	100
10.1.3	Wire feed rollers for cored wire	100
10.1.4	Wire guide	100
11	Appendix A	101
11.1	JOB-List	101
12	Appendix B	102
12.1	Overview of EWM branches	102

2 Safety instructions

2.1 Notes on the use of these operating instructions

DANGER

Working or operating procedures which must be closely observed to prevent imminent serious and even fatal injuries.

- Safety notes include the "DANGER" keyword in the heading with a general warning symbol.
- The hazard is also highlighted using a symbol on the edge of the page.

WARNING

Working or operating procedures which must be closely observed to prevent serious and even fatal injuries.

- Safety notes include the "WARNING" keyword in the heading with a general warning symbol.
- The hazard is also highlighted using a symbol in the page margin.

CAUTION

Working or operating procedures which must be closely observed to prevent possible minor personal injury.













- The safety information includes the "CAUTION" keyword in its heading with a general warning symbol.
- The risk is explained using a symbol on the edge of the page.

Special technical points which users must observe.

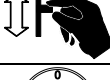
Instructions and lists detailing step-by-step actions for given situations can be recognised via bullet points, e.g.:

- Insert the welding current lead socket into the relevant socket and lock.

2.2 Explanation of icons

Symbol	Description
	Special technical points which users must observe.
	Correct
	Wrong
	Press
	Do not press
	Press and keep pressed
	Turn
	Switch
	Switch off machine
	Switch on machine
ENTER	enter the menu
NAVIGATION	Navigating in the menu
EXIT	Exit the menu
4 s 	Time display (example: wait 4s/press)
	Interruption in the menu display (other setting options possible)
	Tool not required/do not use
	Tool required/use

2.3 General

DANGER



Do not carry out any unauthorised repairs or modifications!

To avoid injury and equipment damage, the unit must only be repaired or modified by specialist, skilled persons!

The warranty becomes null and void in the event of unauthorised interference.

- Appoint only skilled persons for repair work (trained service personnel)!



Electric shock!

Welding machines use high voltages which can result in potentially fatal electric shocks and burns on contact. Even low voltages can cause you to get a shock and lead to accidents.

- Do not touch any live parts in or on the machine!
- Connection cables and leads must be free of faults!
- Switching off alone is not sufficient!
- Place welding torch and stick electrode holder on an insulated surface!
- The unit should only be opened by specialist staff after the mains plug has been unplugged!
- Only wear dry protective clothing!
- Wait for 4 minutes until the capacitors have discharged!

WARNING



Risk of injury due to radiation or heat!

Arc radiation results in injury to skin and eyes.

Contact with hot workpieces and sparks results in burns.

- Use welding shield or welding helmet with the appropriate safety level (depending on the application)!
- Wear dry protective clothing (e.g. welding shield, gloves, etc.) according to the relevant regulations in the country in question!
- Protect persons not involved in the work against arc beams and the risk of glare using safety curtains!



Explosion risk!

Apparently harmless substances in closed containers may generate excessive pressure when heated.

- Move containers with inflammable or explosive liquids away from the working area!
- Never heat explosive liquids, dusts or gases by welding or cutting!



Fire hazard!

Flames may arise as a result of the high temperatures, stray sparks, glowing-hot parts and hot slag produced during the welding process.

Stray welding currents can also result in flames forming!

- Check for fire hazards in the working area!
- Do not carry any easily flammable objects such as matches or lighters.
- Keep appropriate fire extinguishing equipment to hand in the working area!
- Thoroughly remove any residue of flammable substances from the workpiece before starting welding.
- Only continue work on welded workpieces once they have cooled down.
Do not allow to come into contact with flammable material!
- Connect welding leads correctly!

 **WARNING**

Risk of accidents due to non-compliance with the safety instructions!

Non-compliance with the safety instructions can be fatal!

- Carefully read the safety instructions in this manual!
- Observe the accident prevention regulations and any regional regulations!
- Inform persons in the working area that they must comply with the regulations!

Danger when coupling multiple power sources!

Coupling multiple power sources in parallel or in series has to be carried out by qualified personnel and in accordance with the manufacturer's guidelines. Before bringing the power sources into service for arc welding operations, a test has to verify that they cannot exceed the maximum allowed open circuit voltage.

- Connection of the machine may be carried out by qualified personnel only!
- When decommissioning individual power sources, all mains and welding current leads have to be safely disconnected from the welding system as a whole. (Danger due to inverse voltages!)
- Do not couple welding machines with pole reversing switch (PWS series) or machines for AC welding, as a minor error in operation can cause the welding voltages to be combined.

 **CAUTION**

Smoke and gases!

Smoke and gases can lead to breathing difficulties and poisoning. In addition, solvent vapour (chlorinated hydrocarbon) may be converted into poisonous phosgene due to the ultraviolet radiation of the arc!

- Ensure that there is sufficient fresh air!
- Keep solvent vapour away from the arc beam field!
- Wear suitable breathing apparatus if appropriate!



Noise exposure!

Noise exceeding 70 dBA can cause permanent hearing damage!

- Wear suitable ear protection!
- Persons located within the working area must wear suitable ear protection!







Electromagnetic fields!

The power source may cause electrical or electromagnetic fields to be produced which could affect the correct functioning of electronic equipment such as IT or CNC devices, telecommunication lines, power cables, signal lines and pacemakers.



- Observe the maintenance instructions > *see 6 chapter!*
- Unwind welding leads completely!
- Shield devices or equipment sensitive to radiation accordingly!
- The correct functioning of pacemakers may be affected (obtain advice from a doctor if necessary).

-  **Obligations of the operator!**
The respective national directives and laws must be observed for operation of the machine!
- *National implementation of the framework directive (89/391/EWG), as well as the associated individual directives.*
 - *In particular, directive (89/655/EWG), on the minimum regulations for safety and health protection when staff members use equipment during work.*
 - *The regulations regarding work safety and accident prevention for the respective country.*
 - *Setting up and operating the machine according to IEC 60974-9.*
 - *Check at regular intervals that users are working in a safety-conscious way.*
 - *Regular checks of the machine according to IEC 60974-4.*
-  **The manufacturer's warranty becomes void if non-genuine parts are used!**
- *Only use system components and options (power sources, welding torches, electrode holders, remote controls, spare parts and replacement parts, etc.) from our range of products!*
 - *Only insert and lock accessory components into the relevant connection socket when the machine is switched off.*
-  **Damage to the machine due to stray welding currents!**
Stray welding currents can destroy protective earth conductors, damage equipment and electronic devices and cause overheating of components leading to fire.
- *Make sure all welding leads are securely connected and check regularly.*
 - *Always ensure a proper and secure electrical connection to the workpiece!*
 - *Set up, attach or suspend all conductive power source components like casing, transport vehicle and crane frames so they are insulated!*
 - *Do not place any other electronic devices such as drillers or angle grinders, etc., on the power source, transport vehicle or crane frames unless they are insulated!*
 - *Always put welding torches and electrode holders on an insulated surface when they are not in use!*
-  **Requirements for connection to the public mains network**
High-performance machines can influence the mains quality by taking current from the mains network. For some types of machines, connection restrictions or requirements relating to the maximum possible line impedance or the necessary minimum supply capacity at the interface with the public network (Point of Common Coupling, PCC) can therefore apply. In this respect, attention is also drawn to the machines' technical data. In this case, it is the responsibility of the operator, where necessary in consultation with the mains network operator, to ensure that the machine can be connected.

**EMC Machine Classification**

In accordance with IEC 60974-10, welding machines are grouped in two electromagnetic compatibility classes > see 8 chapter:

Class A machines are not intended for use in residential areas where the power supply comes from the low-voltage public mains network. When ensuring the electromagnetic compatibility of class A machines, difficulties can arise in these areas due to interference not only in the supply lines but also in the form of radiated interference.

Class B machines fulfil the EMC requirements in industrial as well as residential areas, including residential areas connected to the low-voltage public mains network.

Setting up and operating

When operating arc welding systems, in some cases, electro-magnetic interference can occur although all of the welding machines comply with the emission limits specified in the standard. The user is responsible for any interference caused by welding.

In order to evaluate any possible problems with electromagnetic compatibility in the surrounding area, the user must consider the following: (see also EN 60974-10 Appendix A)

- *Mains, control, signal and telecommunication lines*
- *Radios and televisions*
- *Computers and other control systems*
- *Safety equipment*
- *The health of neighbouring persons, especially if they have a pacemaker or wear a hearing aid*
- *Calibration and measuring equipment*
- *The immunity to interference of other equipment in the surrounding area*
- *The time of day at which the welding work must be carried out*

Recommendations for reducing interference emission

- *Mains connection, e.g. additional mains filter or shielding with a metal tube*
- *Maintenance of the arc welding equipment*
- *Welding leads should be as short as possible and run closely together along the ground*
- *Potential equalization*
- *Earthing of the workpiece. In cases where it is not possible to earth the workpiece directly, it should be connected by means of suitable capacitors.*
- *Shielding from other equipment in the surrounding area or the entire welding system*

2.4 Transport and installation

WARNING



**Risk of injury due to improper handling of shielding gas cylinders!
Improper handling and insufficient securing of shielding gas cylinders can cause serious injuries!**

- Observe the instructions from the gas manufacturer and any relevant regulations concerning the use of compressed air!
- Place shielding gas cylinders in the holders provided for them and secure with fixing devices.
- Attach the fastening elements within the upper half of the shielding gas cylinder!
- The fastening elements must tightly enclose the shielding gas cylinder!
- Do not attach any element to the shielding gas cylinder valve!
- Avoid heating the shielding gas cylinder!

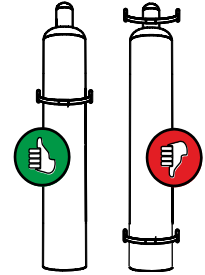

**Risk of accident due to improper transport of machines that may not be lifted!
Do not lift or suspend the machine! The machine can fall down and cause injuries! The handles and brackets are suitable for transport by hand only!**

- The machine may not be lifted by crane or suspended!

CAUTION



Risk of tipping!

There is a risk of the machine tipping over and injuring persons or being damaged itself during movement and set up. Tilt resistance is guaranteed up to an angle of 10° (according to IEC 60974-1).

- Set up and transport the machine on level, solid ground.
- Secure add-on parts using suitable equipment.



Damage due to supply lines not being disconnected!

During transport, supply lines which have not been disconnected (mains supply leads, control leads, etc.) may cause hazards such as connected equipment tipping over and injuring persons!

- Disconnect supply lines!





**The units are designed for operation in an upright position!
Operation in non-permissible positions can cause equipment damage.**

- **Only transport and operate in an upright position!**

2.4.1 Ambient conditions

-  **The machine must not be operated in the open air and must only be set up and operated on a suitable, stable and level base!**
 - **The operator must ensure that the ground is non-slip and level, and provide sufficient lighting for the place of work.**
 - **Safe operation of the machine must be guaranteed at all times.**

-  **Unusually high quantities of dust, acid, corrosive gases or substances may damage the equipment.**
 - **Avoid high volumes of smoke, vapour, oil vapour and grinding dust!**
 - **Avoid ambient air containing salt (sea air)!**

-  **Insufficient ventilation results in a reduction in performance and equipment damage.**
 - **Observe the ambient conditions!**
 - **Keep the cooling air inlet and outlet clear!**
 - **Observe the minimum distance of 0.5 m from obstacles!**

2.4.1.1 In operation

Temperature range of the ambient air:

- -25 °C to +40 °C

Relative air humidity:

- Up to 50% at 40 °C
- Up to 90% at 20 °C

2.4.1.2 Transport and storage

Storage in an enclosed space, temperature range of the ambient air:

- -30 °C to +70 °C

Relative air humidity

- Up to 90% at 20 °C

3 Intended use

WARNING



Hazards due to improper usage!

The machine has been constructed to the state of the art and any regulations and standards applicable for use in industry and trade. It may only be used for the welding procedures indicated at the rating plate. Hazards may arise for persons, animals and material objects if the equipment is not used correctly. No liability is accepted for any damages arising from improper usage!

- The equipment must only be used in line with its designated purpose and by trained or expert personnel!
- Do not improperly modify or convert the equipment!

Arc welding machine for GMAW welding with TIG welding and lift arc (touch starting) or MMA welding as secondary process. It may be possible to expand the functionality by using accessories (see the documentation in the relevant chapter).

3.1 Applications

Machine series	Main process							Secondary process		
	Standard MIG/MAG welding				Pulsed MIG/MAG welding			TIG welding (lift arc)	MMA welding	Gouging
	forceArc	rootArc	coldArc	pipeSolution	forceArc puls	rootArc puls	coldArc puls			
alpha Q puls MM	<input checked="" type="checkbox"/>	<input checked="" type="checkbox"/>	<input checked="" type="checkbox"/>	<input checked="" type="checkbox"/>	<input checked="" type="checkbox"/>	<input checked="" type="checkbox"/>	<input checked="" type="checkbox"/>	<input checked="" type="checkbox"/>	<input checked="" type="checkbox"/>	<input checked="" type="checkbox"/>
Phoenix puls MM	<input checked="" type="checkbox"/>	<input checked="" type="checkbox"/>	<input type="checkbox"/>	<input type="checkbox"/>	<input checked="" type="checkbox"/>	<input checked="" type="checkbox"/>	<input type="checkbox"/>	<input checked="" type="checkbox"/>	<input checked="" type="checkbox"/>	<input checked="" type="checkbox"/>
Taurus Synergic S MM	<input checked="" type="checkbox"/>	<input checked="" type="checkbox"/>	<input type="checkbox"/>	<input type="checkbox"/>	<input type="checkbox"/>	<input type="checkbox"/>	<input type="checkbox"/>	<input checked="" type="checkbox"/>	<input checked="" type="checkbox"/>	<input checked="" type="checkbox"/>

possible

not possible

3.2 Documents which also apply

3.2.1 Warranty

-  For more information refer to the "Warranty registration" brochure supplied and our information regarding warranty, maintenance and testing at www.ewm-group.com!

3.2.2 Declaration of Conformity

 The designated machine conforms to EC Directives and standards in terms of its design and construction:

- EC Low Voltage Directive (2006/95/EC),
- EC EMC Directive (2004/108/EC),

This declaration shall become null and void in the event of unauthorised modifications, improperly conducted repairs, non-observance of the deadlines for the repetition test and / or non-permitted conversion work not specifically authorised by the manufacturer.

The original copy of the declaration of conformity is enclosed with the unit.

3.2.3 Welding in environments with increased electrical hazards

 In compliance with IEC / DIN EN 60974, VDE 0544 the machines can be used in environments with an increased electrical hazard.

3.2.4 Service documents (spare parts and circuit diagrams)

DANGER



Do not carry out any unauthorised repairs or modifications!

To avoid injury and equipment damage, the unit must only be repaired or modified by specialist, skilled persons!

The warranty becomes null and void in the event of unauthorised interference.

- Appoint only skilled persons for repair work (trained service personnel)!

Original copies of the circuit diagrams are enclosed with the unit.

Spare parts can be obtained from the relevant authorised dealer.

3.2.5 Calibration/Validation

We hereby confirm that this machine has been tested using calibrated measuring equipment, as stipulated in IEC/EN 60974, ISO/EN 17662, EN 50504, and complies with the admissible tolerances. Recommended calibration interval: 12 months

4 Machine description – quick overview

4.1 Front view

 *The device configuration shown may differ in case of an additional ex works options or retrofitting options > see 9 chapter.*

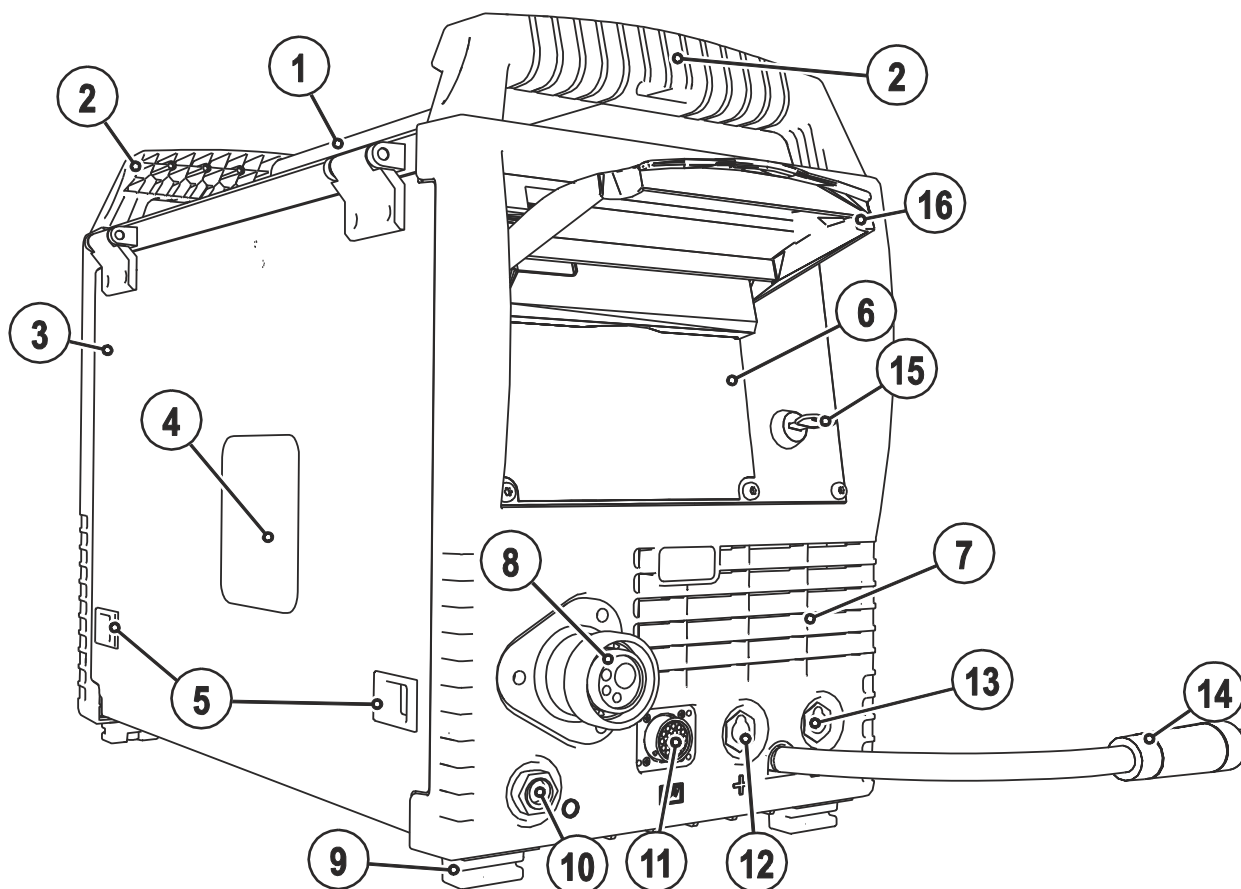







Figure 4-1

Item	Symbol	Description
1		Transport bar
2		Carrying handle
3		Protective cap Cover for the wire feed mechanism and other operating elements. Depending on the machine series, additional stickers with information on the replacement parts and JOB lists will be located on the inside.
4		Wire spool inspection window Check wire supply
5		Slide latch, lock for the protective cap
6		Machine control > see 4.3 chapter
7		Cooling air inlet
8		Welding torch connection (Euro or Dinse torch connector) Welding current, shielding gas and torch trigger integrated
9		Machine feet
10		Park socket, polarity selection plug Retainer for the polarity selection plug in MMA mode or for transport.
11		19-pole connection socket (analogue) For connecting analogue accessory components (remote control, welding torch control lead, etc.)
12		Connection socket, "+" welding current <ul style="list-style-type: none"> •----- MIG/MAG cored wire welding: Workpiece connection •----- TIG welding: Workpiece connection •----- MMA welding: Workpiece connection
13		"-" welding current connection socket <ul style="list-style-type: none"> •----- MIG/MAG welding: Workpiece connection •----- TIG welding: Welding current connection for welding torch •----- MMA welding: electrode holder connection
14		Welding current cable, polarity selection Welding current to Euro torch connector/torch, for polarity selection <ul style="list-style-type: none"> •----- MIG/MAG: Connection socket for "+" welding current •----- Self-shielding flux cored wire/TIG: Connection socket, "-" welding current •----- MMA: Park socket
15		Key switch for protection against unauthorised use > see 5.16 chapter <ul style="list-style-type: none"> 1 ----- changes possible, G front drive-4x-EX 0 ----- changes not possible.
16		Protective cap > see 5.2.1 chapter

4.2 Rear view

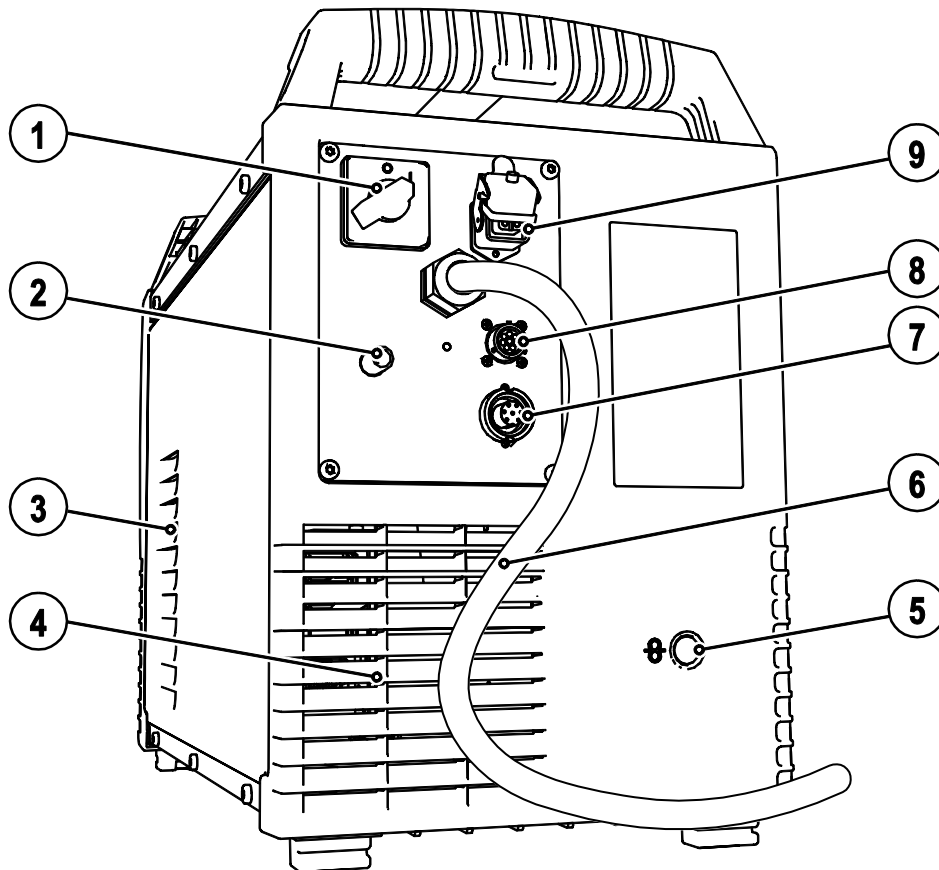







Figure 4-2

Item	Symbol	Description
1		Main switch, machine on/off
2		Connecting nipple G¹/₄, shielding gas connection
3		Cooling air inlet
4		Cooling air outlet
5		External wire feed inlet Pre-cut casing inlet for external wire feed.
6		Mains connection cable > see 5.6 chapter
7	 digital	7-pole connection socket (digital) For connecting digital accessory components (documentation interface, robot interface or remote control, etc.).
8		8-pole connection socket Cooling unit control lead
9		4-pole connection socket Cooling unit voltage supply

4.2.1 Operating elements in the machine

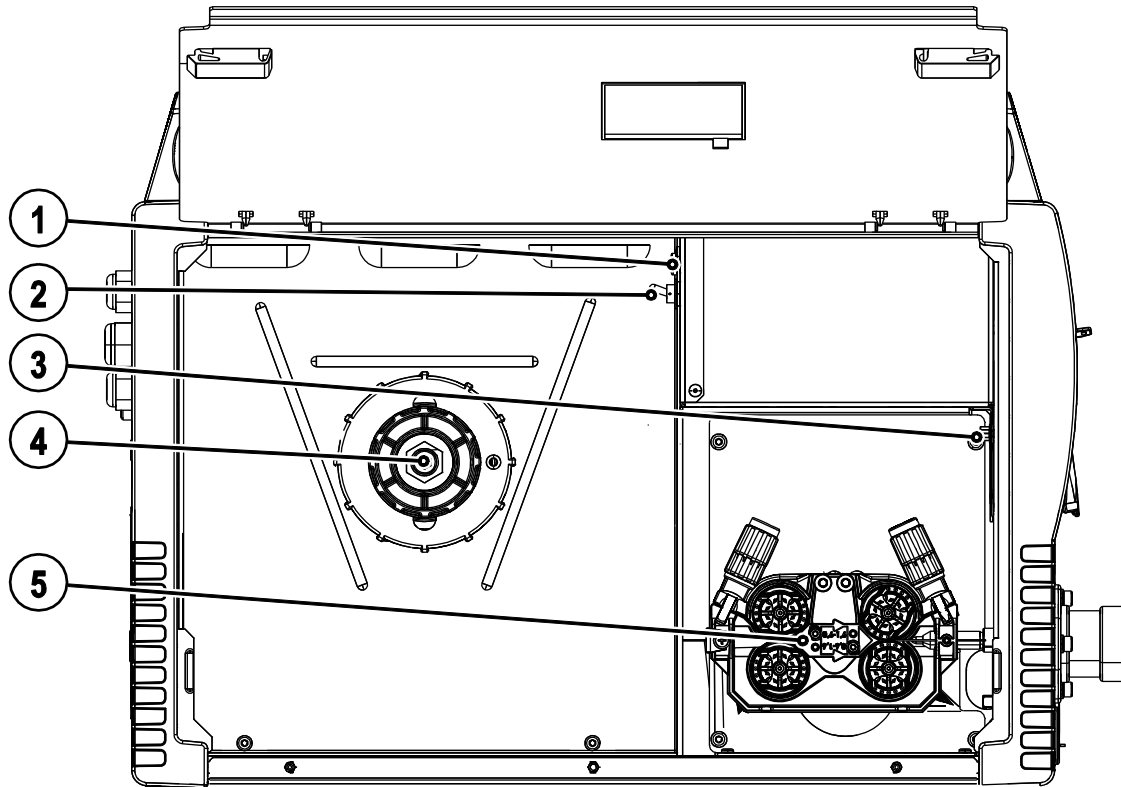







Figure 4-3

Item	Symbol	Description
1		Key button, automatic cutout Wire feed motor supply voltage fuse press to reset a triggered fuse
2		Welding torch function changeover switch (special welding torch required)  Programm Changing over programs or JOBs  Up / Down Infinite adjustment of welding performance.
3		PC interface, serial (D-Sub connection socket, 9-pole)
4		Wire spool holder
5		Wire feed unit

4.3 Machine control – Operating elements

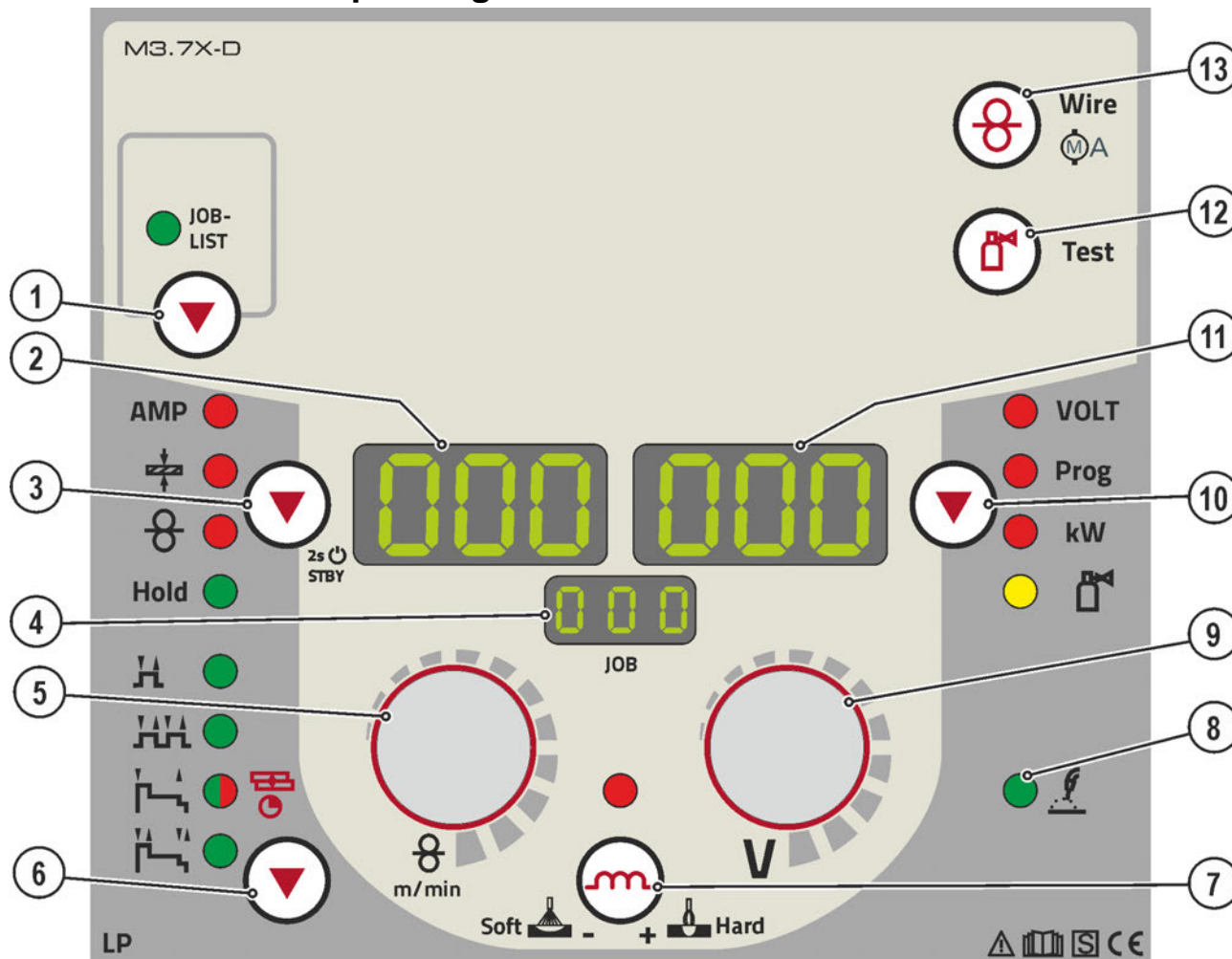

Figure 4-4

Item	Symbol	Description
1		Push-button, welding task selection (JOB) Select the welding task using the welding task list (JOB-LIST) (not applicable for Phoenix Expert). The list can be found inside the protective cap of the wire feed mechanism and in the appendix to these operating instructions.
2		Display, left Welding current, material thickness, wire speed, hold values
3		Push-button, parameter selection left/power-saving mode AMP----- Welding current ⚡----- Material thickness ⊗----- Wire feed speed Hold ----- After welding, the values used last are shown from the main program. The signal light is illuminated. STBY --- Press for 2 s to put machine into power-saving mode. To reactivate, activate one of the operating elements.
4		Display, JOB Shows the currently selected welding task (JOB number).
5		Welding parameter setting, rotary dial For setting the welding performance, for selecting the JOB (welding task) and for setting other welding parameters.

Item	Symbol	Description
6		Select operating mode button ----- Non-latched ----- Latched ----- Signal light lights up in green: Special non-latched ----- Signal light lights up in red: MIG spot welding ----- Special latched
7		Push-button, throttling effect (arc dynamics) ----- Arc is harder and more narrow ----- Arc is softer and wider
8		Standard MIG/MAG welding signal light
9		Arc length correction/selection of welding program, rotary dial •----- Correction of the arc length from -9.9 V to +9.9 V. •----- Selection of welding programs 0 to 15 (not possible if accessory components, such as program torches, are connected).
10		Button, Parameter selection (right) VOLT ---- Welding voltage Prog ---- Program number kW ----- Welding performance display ----- Gas flow quantity (optional)
11		Display, right Welding voltage, program number, motor current (wire feed mechanism)
12		Gas test / rinse button •----- Gas test: For setting the shielding gas quantity •----- Rinse: For rinsing longer hose packages > see 5.8 chapter
13		Push-button, wire inching/motor current (wire feed mechanism) > see 5.10.2.4 chapter

5 Design and function

5.1 General

WARNING



Risk of injury from electric shock!

Contact with live parts, e.g. welding current sockets, is potentially fatal!

- Follow safety instructions on the opening pages of the operating instructions.
- Commissioning may only be carried out by persons who have the relevant expertise of working with arc welding machines!
- Connection and welding leads (e.g. electrode holder, welding torch, workpiece lead, interfaces) may only be connected when the machine is switched off!

CAUTION



Insulate the arc welder from welding voltage!

Not all active parts of the welding current circuit can be shielded from direct contact. To avoid any associated risks it is vital for the welder to adhere to the relevant safety regulations. Even low voltages can cause a shock and lead to accidents.

- Wear dry and undamaged protective clothing (shoes with rubber soles/welder's gloves made from leather without any studs or braces)!
- Avoid direct contact with non-insulated connection sockets or connectors!
- Always place torches and electrode holders on an insulated surface!



Risk of burns on the welding current connection!

If the welding current connections are not locked, connections and leads heat up and can cause burns, if touched!

- Check the welding current connections every day and lock by turning in clockwise direction, if necessary.



Risk of injury due to moving parts!

The wire feeders are equipped with moving parts, which can trap hands, hair, clothing or tools and thus injure persons!

- Do not reach into rotating or moving parts or drive components!
- Keep casing covers or protective caps closed during operation!

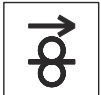

Risk of injury due to welding wire escaping in an unpredictable manner!

Welding wire can be conveyed at very high speeds and, if conveyed incorrectly, may escape in an uncontrolled manner and injure persons!



- Before mains connection, set up the complete wire guide system from the wire spool to the welding torch!
- Remove the pressure rollers from the wire feeder if no welding torch is fitted!
- Check wire guide at regular intervals!
- Keep all casing covers or protective caps closed during operation!



Risk from electrical current!

If welding is carried out alternately using different methods and if a welding torch and an electrode holder remain connected to the machine, the open-circuit/welding voltage is applied simultaneously on all cables.

- The torch and the electrode holder should therefore always be placed on an insulated surface before starting work and during breaks.

-  **Accessory components and the power source itself can be damaged by incorrect connection!**
- **Only insert and lock accessory components into the relevant connection socket when the machine is switched off.**
 - **Comprehensive descriptions can be found in the operating instructions for the relevant accessory components.**
 - **Accessory components are detected automatically after the power source is switched on.**
-  **Protective dust caps protect the connection sockets and therefore the machine against dirt and damage.**
- **The protective dust cap must be fitted if there is no accessory component being operated on that connection.**
 - **The cap must be replaced if faulty or if lost!**

5.2 Installation

WARNING



Risk of accident due to improper transport of machines that may not be lifted!

Do not lift or suspend the machine! The machine can fall down and cause injuries! The handles and brackets are suitable for transport by hand only!

- The machine may not be lifted by crane or suspended!
- Depending on machine type, equipment for lifting by crane or use while suspended is available as a retrofitting option > see 9 chapter.

-  **The machine must not be operated in the open air and must only be set up and operated on a suitable, stable and level base!**
- **The operator must ensure that the ground is non-slip and level, and provide sufficient lighting for the place of work.**
 - **Safe operation of the machine must be guaranteed at all times.**

5.2.1 Protective flap, welding machine control

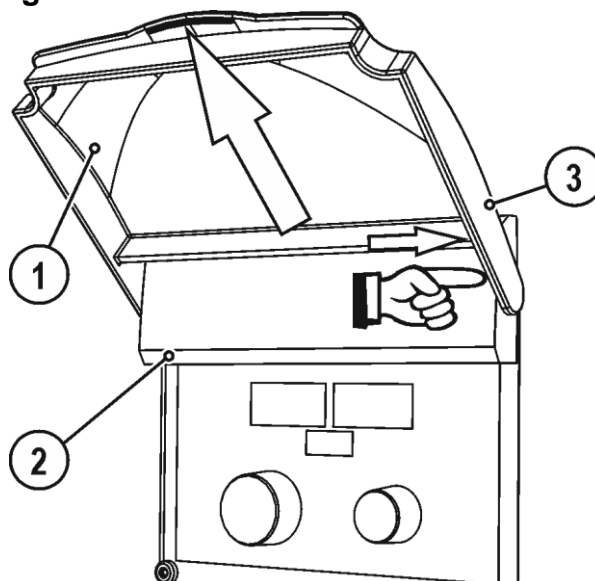

Figure 5-1

Item	Symbol	Description
1		Protective cap
2		Lid
3		Bracket, protective cap

- Push the right-hand bracket of the protective cap to the right and remove the protective cap.

5.2.2 Welding torch holder

The item described in the following is part of the machine's scope of delivery.

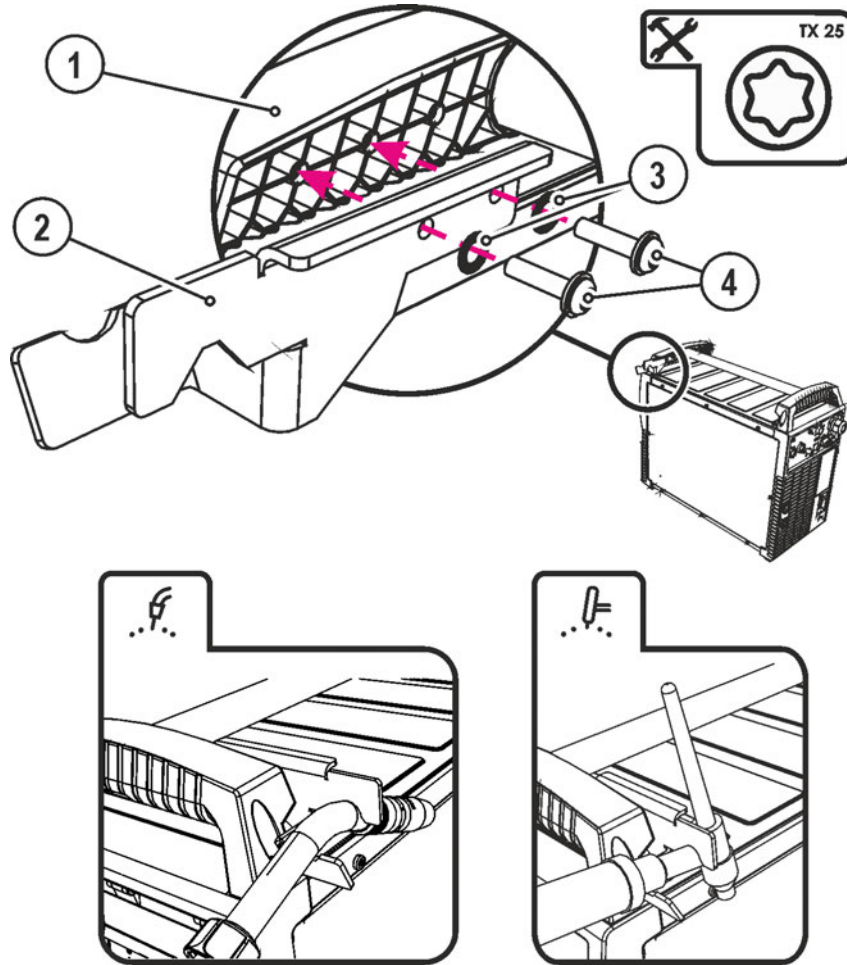

Figure 5-2

Item	Symbol	Description
1		Crossmember of the transport handle
2		Torch holder
3		Fan-type lock washers
4		Fixing screws (x 4)

- Use the mounting screws to screw the torch holder onto the crossmember of the transport handle.
- Insert the welding torch into the welding torch holder as shown.

5.3 Machine cooling

To obtain an optimal duty cycle from the power components, the following precautions should be observed:

- Ensure that the working area is adequately ventilated.
- Do not obstruct the air inlets and outlets of the machine.
- Do not allow metal parts, dust or other objects to get into the machine.

5.4 Workpiece lead, general

⚠ CAUTION



Risk of burns due to incorrect connection of the workpiece lead!
Paint, rust and dirt on the connection restrict the power flow and may lead to stray welding currents.

Stray welding currents may cause fires and injuries!

- Clean the connections!
- Fix the workpiece lead securely!
- Do not use structural parts of the workpiece as a return lead for the welding current!
- Take care to ensure faultless power connections!

5.5 Notes on the installation of welding current leads

- 👉 *Incorrectly installed welding current leads can cause faults in the arc (flickering).*
- 👉 *Lay the workpiece lead and hose package of power sources without HF igniter (MIG/MAG) for as long and as close as possible in parallel.*
- 👉 *Lay the workpiece lead and hose package of power sources with HF igniter (TIG) for as long as possible in parallel with a distance of 20 cm to avoid HF sparkover.*
- 👉 *Always keep a distance of at least 20 cm to leads of other power sources to avoid interferences*
- 👉 *Always keep leads as short as possible! For optimum welding results max. 30 m (welding lead + intermediate hose package + torch lead).*

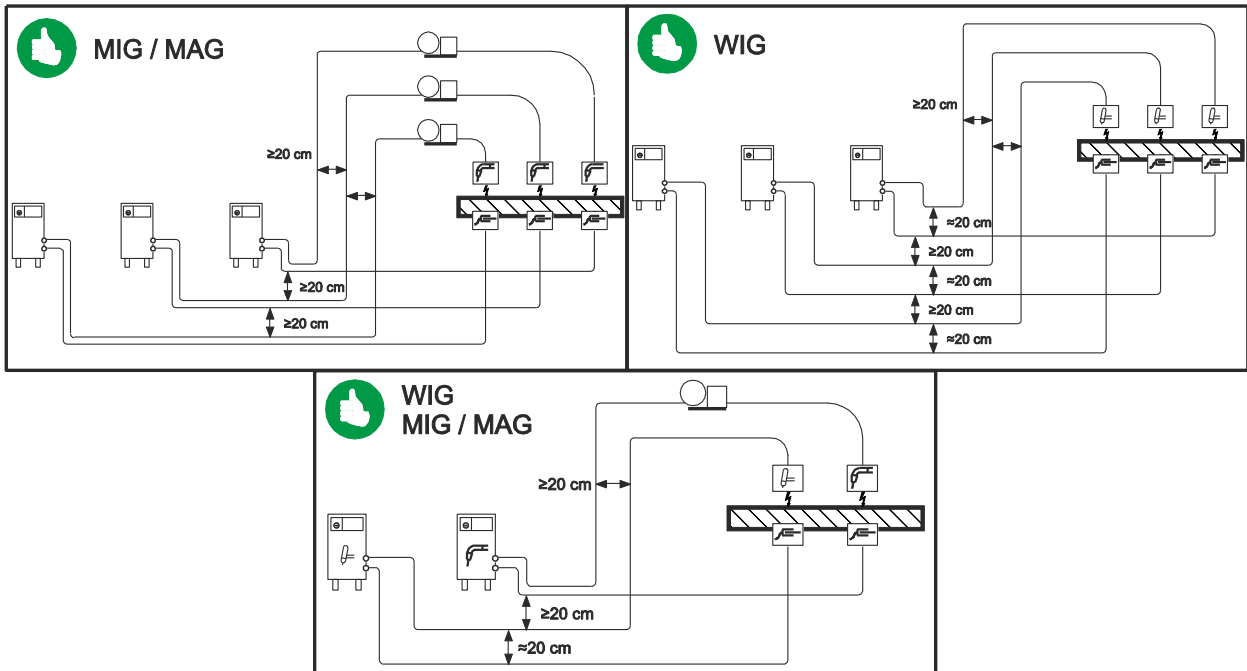

Figure 5-3

Use an individual welding lead to the workpiece for each welding machine!

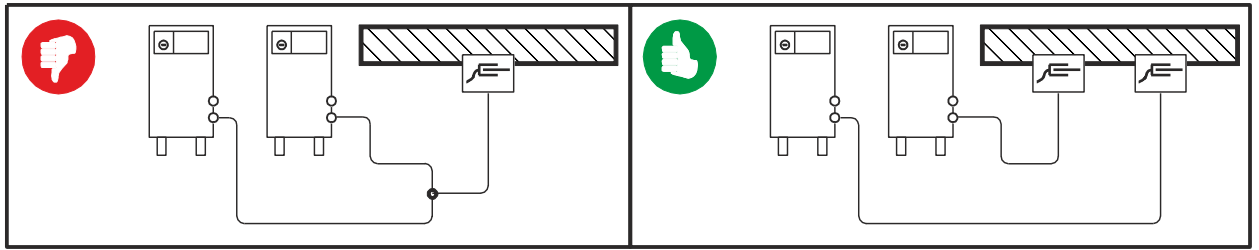

Figure 5-4

Fully unroll welding current leads, torch hose packages and intermediate hose packages. Avoid loops!

Always keep leads as short as possible!

Lay any excess cable lengths in meanders.

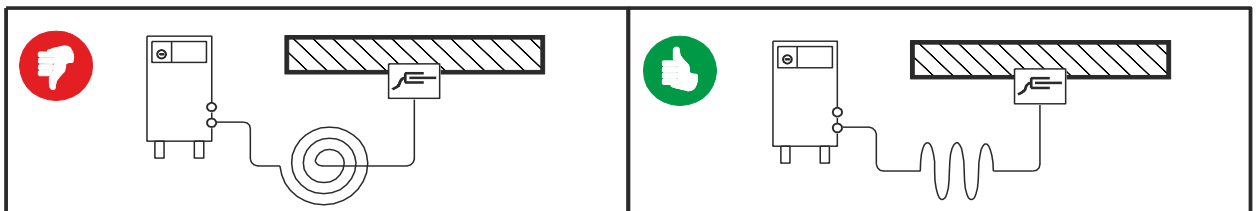

Figure 5-5

5.6 Mains connection

⚠ DANGER



Hazard caused by improper mains connection!

An improper mains connection can cause injuries or damage property!

- Only use machine with a plug socket that has a correctly fitted protective conductor.
- If a mains plug must be fitted, this may only be carried out by an electrician in accordance with the relevant national provisions or regulations!
- Mains plug, socket and lead must be checked regularly by an electrician!
- When operating the generator always ensure it is earthed as stated in the operating instructions. The resulting network has to be suitable for operating devices according to protection class 1.

5.6.1 Mains configuration



The machine may be connected to:

- a three-phase system with four conductors and an earthed neutral conductor
- a three-phase system with three conductors of which any one can be earthed, e.g. the outer conductor

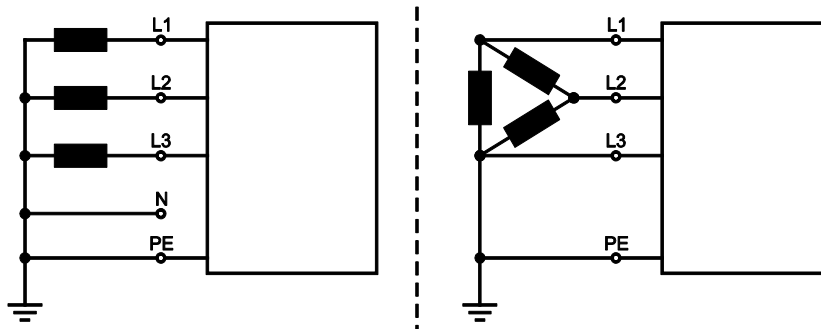

Figure 5-6

Legend

Item	Designation	Colour code
L1	Outer conductor 1	brown
L2	Outer conductor 2	black
L3	Outer conductor 3	grey
N	Neutral conductor	blue
PE	Protective conductor	green-yellow



The operating voltage shown on the rating plate must be consistent with the mains voltage, in order to avoid damage to the machine > see 8 chapter!

- Insert mains plug of the switched-off machine into the appropriate socket.

5.7 Welding torch cooling system

5.7.1 Welding torch cooling unit connection

Please note the relevant documentation of the accessory components.

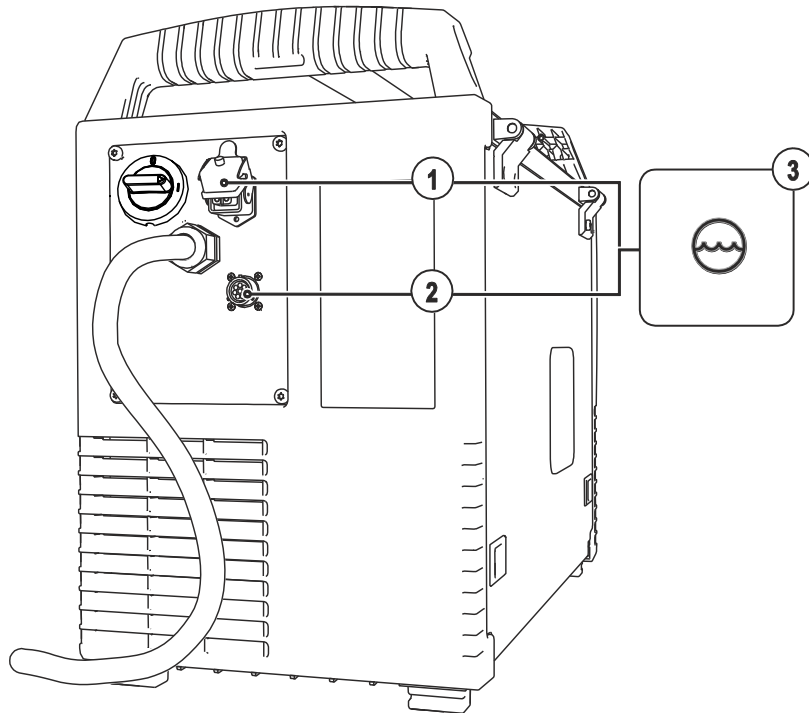

Figure 5-7

Item	Symbol	Description
1		4-pole connection socket Cooling unit voltage supply
2		8-pole connection socket Cooling unit control lead
3		Cooling unit

- Insert and lock the 8-pole control lead plug on the cooling unit into the 8-pole connection socket on the welding machine.
- Insert and lock the 4-pole supply plug on the cooling unit into the 4-pole connection socket on the welding machine.

5.8 Shielding gas supply (shielding gas cylinder for welding machine)

⚠ WARNING



Incorrect handling of shielding gas cylinders!

Incorrect handling of shielding gas cylinders can result in serious and even fatal injury.

- Observe the instructions from the gas manufacturer and in any relevant regulations concerning the use of compressed air!
- Place shielding gas cylinders in the holders provided for them and secure with fixing devices.
- Avoid heating the shielding gas cylinder!

☞ **An unhindered shielding gas supply from the shielding gas cylinder to the welding torch is a fundamental requirement for optimum welding results. In addition, a blocked shielding gas supply may result in the welding torch being destroyed.**

- **Always re-fit the yellow protective cap when not using the shielding gas connection.**
- **All shielding gas connections must be gas tight.**

☞ **Before connecting the pressure regulator to the gas cylinder, open the cylinder valve briefly to expel any dirt.**

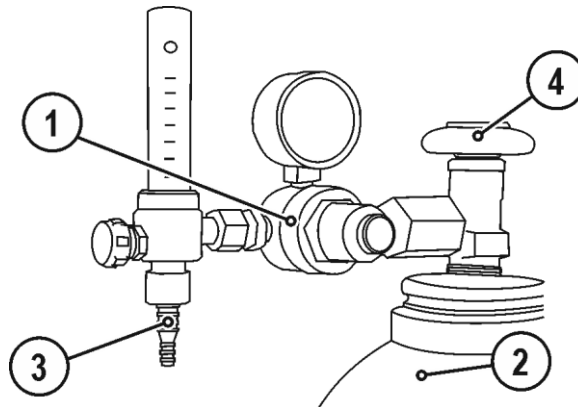



Figure 5-8

Item	Symbol	Description
1		Pressure regulator
2		Shielding gas cylinder
3		Output side of the pressure regulator
4		Cylinder valve



- Place the shielding gas cylinder into the relevant cylinder bracket.
- Secure the shielding gas cylinder using a securing chain.
- Tighten the pressure regulator screw connection on the gas bottle valve to be gas-tight.
- Tighten gas hose on pressure regulator to be gas tight.
- Fasten the gas hose to the shielding gas connecting nipple at the back of the machine using the crown nut.

5.8.1 Gas test

- Slowly open the gas cylinder valve.
- Open the pressure regulator.
- Switch on the power source at the main switch.
- Set the relevant gas quantity for the application on the pressure regulator.
- The gas test is triggered on the control or inside the machine by pressing the  push-button briefly.

Shielding gas flows for around 25 seconds or until the button is pressed again.

5.8.2 Rinse hose package function

Operating element	Action	Result
	 5 s	Rinse hose package selection. Shielding gas flows for approx. 5 minutes or until the gas test push-button is pressed again.

5.8.3 Gas test – setting the shielding gas volume

Welding process	Recommended shielding gas quantity
MAG welding	Wire diameter x 11.5 = l/min
MIG brazing	Wire diameter x 11.5 = l/min
MIG welding (aluminium)	Wire diameter x 13.5 = l/min (100 % argon)
TIG	Gas nozzle diameter in mm corresponds to l/min gas throughput

Helium-rich gas mixtures require a higher gas volume!

The table below can be used to correct the gas volume calculated where necessary:

Shielding gas	Factor
75% Ar/25% He	1.14
50% Ar/50% He	1.35
25% Ar/75% He	1.75
100% He	3.16

Incorrect shielding gas setting!

- **If the shielding gas setting is too low or too high, this can introduce air to the weld pool and may cause pores to form.**
- **Adjust the shielding gas quantity to suit the welding task!**

5.9 Welding data display

To the left and right of the control displays are the "Parameter selection" buttons (◂). They are used to select welding parameters to be displayed.

Each press of the button advances the display to the next parameter (LEDs next to the button indicate the selection). After the last parameter is reached, the system starts again from the beginning.



Figure 5-9

The display shows:

- Nominal values (before welding)
- Actual values (during welding)
- Hold values (after welding)

MIG/MAG

Parameter	Nominal values	Actual values	Hold values
Welding current	<input checked="" type="checkbox"/>	<input checked="" type="checkbox"/>	<input checked="" type="checkbox"/>
Material thickness	<input checked="" type="checkbox"/>	<input type="checkbox"/>	<input type="checkbox"/>
Wire feed speed	<input checked="" type="checkbox"/>	<input checked="" type="checkbox"/>	<input checked="" type="checkbox"/>
Welding voltage	<input checked="" type="checkbox"/>	<input checked="" type="checkbox"/>	<input checked="" type="checkbox"/>
Welding performance	<input type="checkbox"/>	<input checked="" type="checkbox"/>	<input checked="" type="checkbox"/>

TIG

Parameter	Nominal values	Actual values	Hold values
Welding current	<input checked="" type="checkbox"/>	<input checked="" type="checkbox"/>	<input checked="" type="checkbox"/>
Welding voltage	<input checked="" type="checkbox"/>	<input checked="" type="checkbox"/>	<input checked="" type="checkbox"/>
Welding performance	<input type="checkbox"/>	<input checked="" type="checkbox"/>	<input checked="" type="checkbox"/>

MMA

Parameter	Nominal values	Actual values	Hold values
Welding current	<input checked="" type="checkbox"/>	<input checked="" type="checkbox"/>	<input type="checkbox"/>
Welding voltage	<input checked="" type="checkbox"/>	<input checked="" type="checkbox"/>	<input type="checkbox"/>
Welding performance	<input type="checkbox"/>	<input checked="" type="checkbox"/>	<input type="checkbox"/>

When settings are changed (e.g. wire feed speed) the display immediately switches to nominal value setting.

5.10 MIG/MAG welding

5.10.1 Welding torch and workpiece line connection



On delivery, the Euro torch connector is fitted with a capillary tube for welding torches with a steel liner. Conversion is necessary if a welding torch with a liner is used!

- ***Operate welding torches with a liner > with a guide tube.***
- ***Operate welding torches with a steel liner > with a capillary tube.***

Depending on the wire electrode diameter or type, either a steel liner or liner with the correct inner diameter must be inserted in the torch!

Recommendation:

- Use a steel liner when welding hard, unalloyed wire electrodes (steel).
- Use a chrome nickel liner when welding hard, high-alloy wire electrodes (CrNi).
- Use a liner to weld or braze soft wire electrodes, high-alloy wire electrodes or aluminium materials.

Preparation for connecting welding torches with a liner:

- Push forward the capillary tube on the wire feed side in the direction of the Euro torch connector and remove it there.
- Insert the liner guide tube from the Euro torch connector side.
- Carefully insert the welding torch connector with as yet too long a liner into the Euro torch connector and secure with a crown nut.
- Cut off the liner with a liner cutter > see 9 chapter just before the wire feed roller.
- Loosen the welding torch connector and remove.
- Carefully chamfer the cut off end of the liner with a liner sharpener > see 9 chapter and sharpen.



Some wire electrodes (e.g. self-shielding cored wire) are welded using negative polarity. In this case, the welding current lead should be connected to the "-" welding current socket, and the workpiece lead should be connected to the "+" welding current socket. Observe the information from the electrode manufacturer!

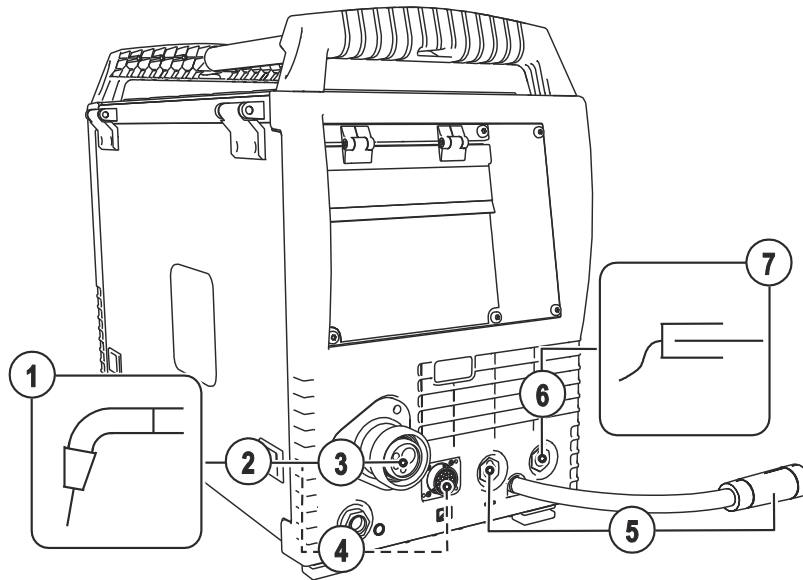

Figure 5-10

Item	Symbol	Description
1		Welding torch
2		Welding torch hose package
3		Welding torch connection (Euro or Dinse torch connector) Welding current, shielding gas and torch trigger integrated
4		19-pole connection socket (analogue) Connection for welding torch control lead
5		Welding current cable, polarity selection Welding current to central connection/torch. Permits polarity selection for MIG/MAG welding. • ----- Standard applications > Connection for "+" welding current connection socket
6		"-" welding current connection socket • ----- MIG/MAG welding: Workpiece connection
7		Workpiece

- Insert the central plug for the welding torch into the central connector and screw together with crown nut.
- Insert the plug on the workpiece lead into the "-" welding current connection socket and lock.
- Welding current lead, insert polarity selection into the "+" welding current connection socket and lock.

Where applicable:

- Insert the welding torch control cable into the 19-pole connection socket and lock (MIG/MAG torches with additional control cables only).
- Lock connecting nipples of the cooling water tubes into the corresponding quick connect couplings: Return line red to quick connect coupling, red (coolant return) and supply line blue to quick connect coupling, blue (coolant supply).

5.10.2 Wire feed

5.10.2.1 Open the protective flap of the wire feeder

To perform the following steps, the protective flap of the wire feeder needs to be opened. Make sure to close the protective flap again before starting to work.

- Unlock and open protective flap.

5.10.2.2 Inserting the wire spool

CAUTION



Risk of injury due to incorrectly secured wire spool.

If the wire spool is not secured properly, it may come loose from the wire spool holder and fall to the ground, causing damage to the machine and injuries.

- Securely fasten the wire spool to the wire spool holder using the knurled nut.
- Before you start working, always check the wire spool is securely fastened.



Standard D300 wire spool holder can be used. Adapters > see 9 chapter are required when using standardised basket coils (DIN 8559).

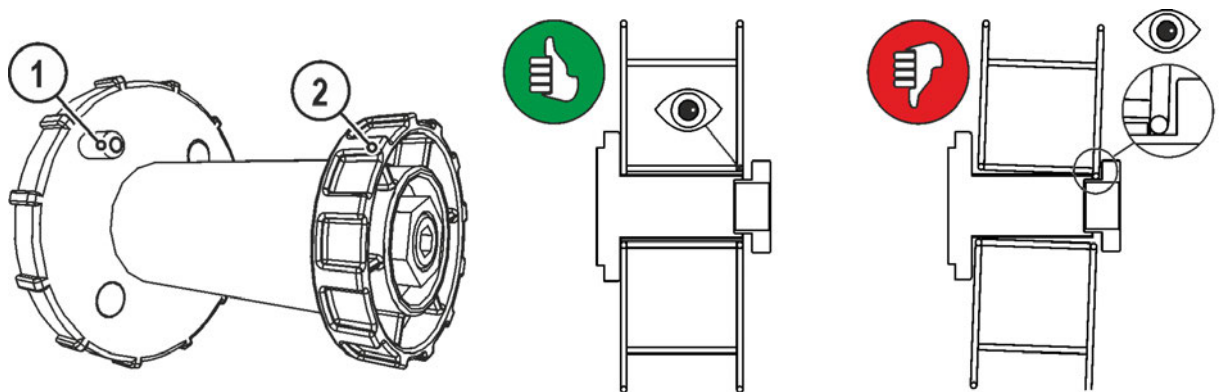

Figure 5-11

Item	Symbol	Description
1		Carrier pin For fixing the wire spool
2		Knurled nut For fixing the wire spool

- Loosen knurled nut from spool holder.
- Fix welding wire reel onto the spool holder so that the carrier pin locks into the spool bore.
- Fasten wire spool using knurled nut.

5.10.2.3 Changing the wire feed rollers

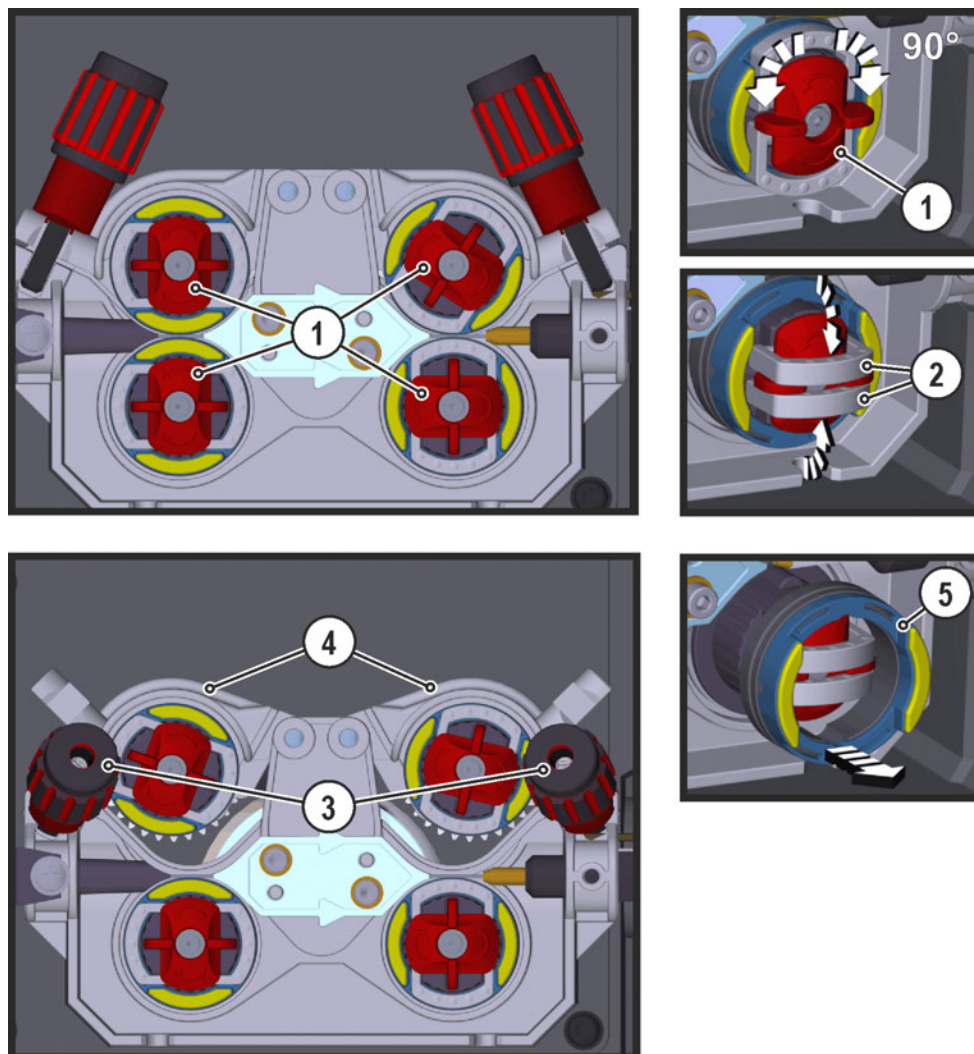

Figure 5-12

Item	Symbol	Description
1		Tommy The tommy is used to secure the closure brackets of the wire feed rollers.
2		Closure bracket The closure brackets are used to secure the wire feed rollers.
3		Feed roll tensioner Fixing the clamping unit and setting the pressure.
4		Clamping unit
5		Wire feed roller see the Wire feed roller overview table

- Rotate the tommy by 90° clockwise or anti-clockwise (tommy locks into place).
- Fold the closure brackets outwards by 90°.
- Unfasten pressure units and fold out (clamping units and pressure rollers will automatically flip upwards).
- Remove the wire feed rollers from the roller support.
- Select new wire feed rollers according to the Wire feed roller overview table and reassemble the wire feed mechanism in reverse order.



Unsatisfactory welding results due to faulty wire feeding!

The wire feed rolls must be suitable for the diameter of the wire and the material. The wire feed rolls are colour-coded to facilitate distinction (see the Wire feed roll overview table). When working with a wire diameter of > 1.6 mm the drive has to be converted for the wire feed kit ON WF 2,0-3,2MM EFEEED > see 10 chapter.

Wire feed roller overview table

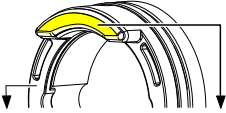
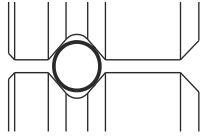
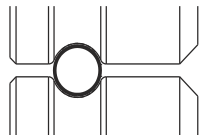
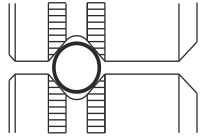
Material	Diameter		Colour code		Groove form	
	Ø mm	Ø inch				
Steel Stainless steel Brazing	0.6	.023	monochrome	light pink	-	 V-groove
	0.8	.030		white		
	0.9/1.0	.035/.040		blue		
	1.2	.045		red		
	1.4	.052		green		
	1.6	.060		black		
	2.0	.080		grey		
	2.4	.095		brown		
	2.8	.110		Light green		
	3.2	.125		purple		
Aluminium	0.8	.030	bichrome	white	yellow	 U-groove
	0.9/1.0	.035/.040		blue		
	1.2	.045		red		
	1.6	.060		black		
	2.0	.080		grey		
	2.4	.095		brown		
	2.8	.110		Light green		
	3.2	.125		purple		
Flux cored wire	0.8	.030	bichrome	white	orange	 V-groove, knurled
	0.9	.035		blue		
	1.0	.040				
	1.2	.045		red		
	1.4	.052		green		
	1.6	.060		black		
	2.0	.080		grey		
	2.4	.095		brown		

5.10.2.4 Inching the wire electrode

CAUTION



Risk of injury due to moving parts!

The wire feeders are equipped with moving parts, which can trap hands, hair, clothing or tools and thus injure persons!

- Do not reach into rotating or moving parts or drive components!
- Keep casing covers or protective caps closed during operation!



Risk of injury due to welding wire escaping in an unpredictable manner!

Welding wire can be conveyed at very high speeds and, if conveyed incorrectly, may escape in an uncontrolled manner and injure persons!

- Before mains connection, set up the complete wire guide system from the wire spool to the welding torch!
- Remove the pressure rollers from the wire feeder if no welding torch is fitted!
- Check wire guide at regular intervals!
- Keep all casing covers or protective caps closed during operation!



Risk of injury due to welding wire escaping from the welding torch!

The welding wire can escape from the welding torch at high speed and cause bodily injury including injuries to the face and eyes!

- Never direct the welding torch towards your own body or towards other persons!



Incorrect contact pressure will cause extensive wear of the wire feed rollers!

- ***With the adjusting nuts of the pressure units set the contact pressure so that the wire electrode is conveyed but will still slip through if the wire spool jams.***
- ***Set the contact pressure of the front rollers (in wire feed direction) to a higher value!***



The inching speed is infinitely adjustable by simultaneously pressing the wire inching push-button and turning the wire speed rotary knob. The left display shows the wire feed speed selected, the right display shows the current motor current of the wire feed mechanism.

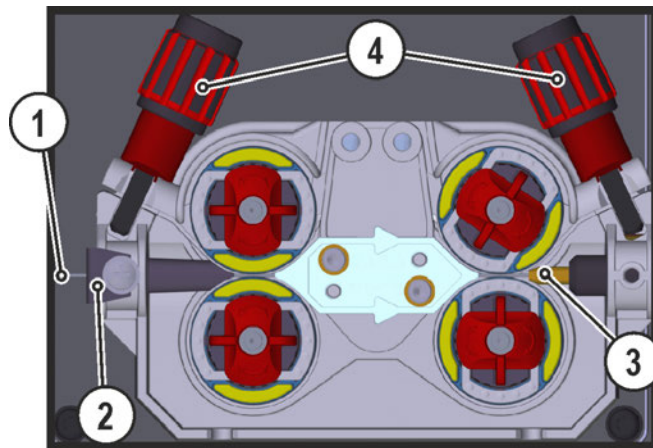

Figure 5-13

Item	Symbol	Description
1		Welding wire
2		Wire feed nipple
3		Guide tube
4		Adjusting nut

- Extend and lay out the torch hose package.
- Carefully unwind the welding wire from the wire spool and insert through the wire feed nipples up to the wire feed rollers.
- Press the inching push-button (the drive catches the welding wire and automatically guides it to the welding torch outlet).



A prerequisite for the automatic inching process is the correct preparation of the wire guide, especially in the capillary and wire guide tube area > see 5.10.1 chapter.

- The contact pressure has to be adjusted separately for each side (wire inlet/outlet) at the feed roll tensioner setting nuts depending on the welding consumable used. A table with the setting values can be found on a sticker near the wire drive.

Version 1: left hand mounting

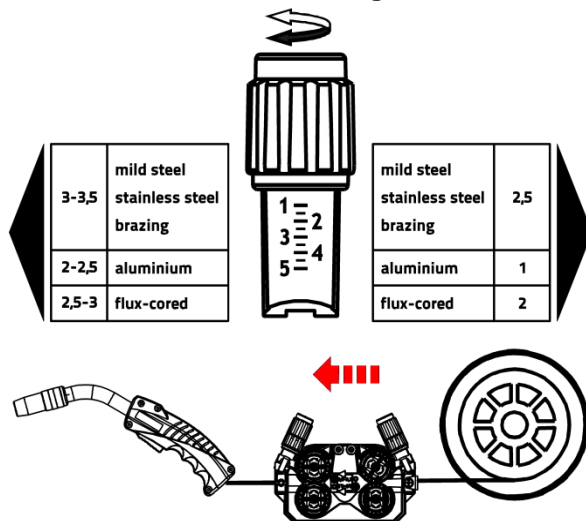

Version 2: right hand mounting

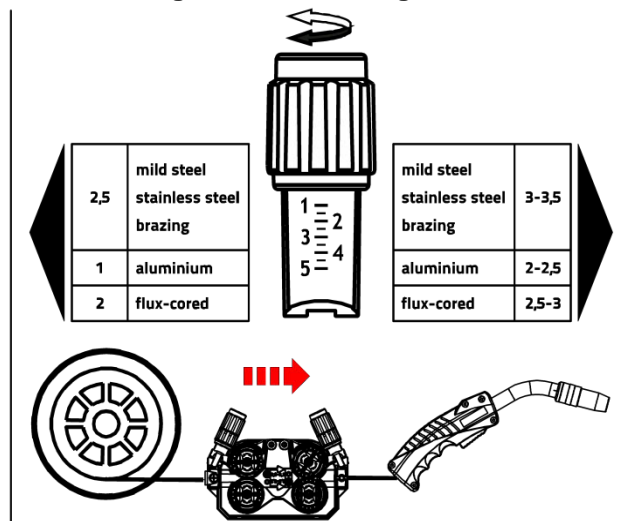

Figure 5-14

Automatic inching stop

Touch the welding torch against the workpiece during inching. Inching of the welding wire will stop as soon it touches the workpiece.

5.10.2.5 Spool brake setting

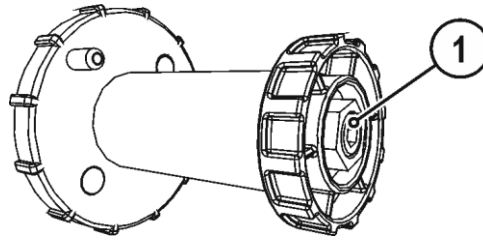

Figure 5-15

Item	Symbol	Description
1		Allen screw Securing the wire spool retainer and adjustment of the spool brake

- Tighten the Allen screw (8 mm) in the clockwise direction to increase the braking effect.



Tighten the spool brake until the wire spool no longer turns when the wire feed motor stops but without it jamming during operation!

5.10.3 Definition of MIG/MAG welding tasks

This machine series offers user-friendly operation and a multitude of features.

- Various welding tasks (JOBS) consisting of welding procedure, material type, wire diameter and shielding gas type have been predefined > see 11.1 chapter.
- The system calculates the required process parameters depending on the operating point specified (one-knob operation via wire feed speed rotary transducer).
- You can adjust additional parameters at the machine control or using the PC300.NET welding parameter software, if required.

5.10.4 Welding task selection

5.10.4.1 Basic welding parameters

You can only change the JOB number when no welding current is flowing.

Operating element	Action	Result	Display
	1 x	Select JOB list	
		Set JOB number. Wait 3s until the setting has been adopted.	

5.10.4.2 Operating mode

Operating element	Action	Result	Display
	n x	Select operating mode The LED displays the selected operating mode. H Non-latched operation HH Latched operation Green Special non-latched mode Red Spot operating mode Special latched mode	No change

5.10.4.3 Choke effect / dynamics

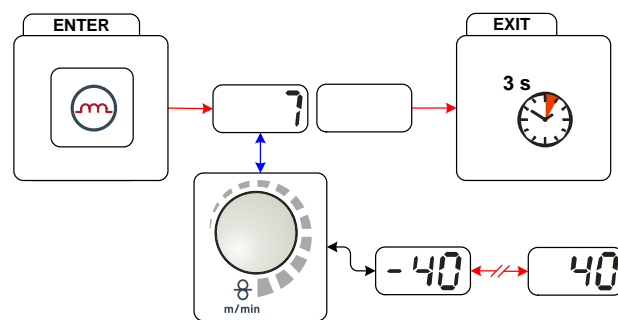

Figure 5-16

Display	Setting/selection
	Dynamics setting 40: Arc harder and narrower -40: Arc softer and wider

5.10.5 MIG/MAG operating point

The operating point (welding output) is specified using the principle of MIG/MAG one-dial operation, i.e. the user need only specify the operating point by setting the required wire speed, for example, and the digital system will calculate the optimum values for welding current and voltage (operating point).

The operating point setting can also be specified using the accessory components such as the remote control, welding torch, etc.

5.10.5.1 Selecting the display unit



Figure 5-17

The operating point (welding performance) can be displayed as the welding current, material thickness or wire speed.

Operating element	Action	Result
	n x	Switching the display between: AMP Welding current Material thickness Wire speed

Application example

Aluminium is to be welded.

- Material = AlMg,
- Gas = Ar 100%,
- Wire diameter = 1.2 mm

The correct wire speed is not known and is to be determined.

- Select the appropriate JOB (> see 11.1 chapter)
- Switch to the material thickness display
- Set the material thickness as appropriate (e.g. 5 mm)
- Switch to the wire speed display

The resulting wire speed will be shown (e.g. 8.4 m/min).



5.10.5.2 Operating point setting using material thickness

Given below is a description of the setting work via the wire speed parameters as an example of operating point setting.

Operating element	Action	Result	Display
		Increase or reduce welding performance via the wire speed parameter. Display example: 10.5 m/min	

5.10.5.3 Arc length correction setting

The arc length can be corrected as follows.

Operating element	Action	Result	Display
		"Arc length correction" setting (Display example: -0.9V, setting range -9.9 V to +9.9 V)	

5.10.5.4 Accessory components for operating point setting

The operating point can also be set with various accessory components such as

- remote controls
- special torches
- PC software
- robot and industrial bus interfaces (optional interface for automated welding required – not possible for all machines in this series!)

For an overview of the accessory components > see 9 chapter See the operating instructions for the machine in question for a more detailed description of the individual machines and their functions.

5.10.5.5 forceArc

Low-heat, directionally stable and powerful high-performance arc with deep fusion penetration for the upper power range Unalloyed, low-alloy and high-alloy steels as well as high-tensile fine-grained steels.

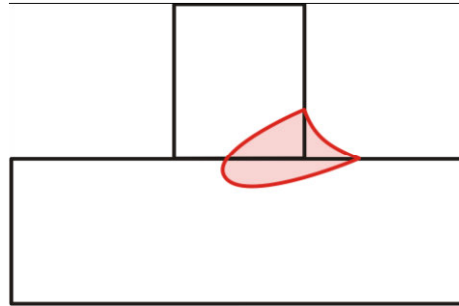

Figure 5-18

- Smaller included angle due to deep penetration and directionally stable arc
- Excellent root and sidewall fusion
- Secure welding also with very long stick-outs
- Reduced undercuts
- Un-, low- and high-alloyed steels as well as high-tensile fine-grained building steels
- Manual and automated applications

forceArc welding from:		Wire Ø (mm)							
		0.8		1		1.2		1.6	
Material	Gas	JOB	Ø	JOB	Ø	JOB	Ø	JOB	Ø
Steel	Ar 91–99%	190	17.0	254	12.0	255	9.5	256	7.0
	Ar 80–90%	189	17.0	179	12.0	180	9.5	181	6.0
CrNi	Ar 91–99%	-	-	251	12.0	252	12.0	253	6.0

You can make use of these properties after selecting the forceArc process > see 5.10.4 chapter.

As with pulse arc welding, it is important to make sure of a good welding current connection.

- Keep welding current cables as short as possible and ensure that cable cross-sections are adequate!
- Fully unroll welding current cables, torch hose packages and, if applicable, intermediate hose packages. Avoid loops!
- Use welding torches, preferably water-cooled, that are suitable for the higher power range.
- Use welding wire with adequate copper coating when welding steel. The wire spool should have layer spooling.



Unstable arc!

Welding current cables that are not fully unrolled can cause faults in the arc (flickering).

- **Fully unroll welding current cables, torch hose packages and, if applicable, intermediate hose packages. Avoid loops!**

5.10.5.6 rootArc

Short arc with perfect weld modelling capabilities for effortless gap bridging, especially for positional welding

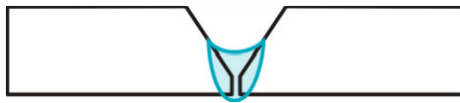

Figure 5-19

- Reduced spatter compared to standard short arc
- Good root formation and secure sidewall fusion
- Un-alloyed and low-alloy steels
- Manual and automated applications

rootArc welding up to:		Wire Ø (mm)											
		0.6		0.8		0.9		1		1.2		1.6	
Material	Gas	JOB	⊗	JOB	⊗	JOB	⊗	JOB	⊗	JOB	⊗	JOB	⊗
Steel	CO ₂	-	-	-	-	-	-	204	7.0	205	5.0	-	-
	Ar 80–90%	-	-	-	-	-	-	206	8.0	207	6.0	-	-



Unstable arc!

Welding current cables that are not fully unrolled can cause faults in the arc (flickering).

- *Fully unroll welding current cables, torch hose packages and, if applicable, intermediate hose packages. Avoid loops!*

5.10.6 MIG/MAG functional sequences / operating modes

 *There are optimum pre-sets for welding parameters such as gas pre-flow and burn back, etc. for numerous applications (although these can also be changed if required).*

5.10.6.1 Explanation of signs and functions

Symbol	Meaning
	Press torch trigger
	Release torch trigger
	Tap torch trigger (press briefly and release)
	Shielding gas flowing
I	Welding output
	Wire electrode is being conveyed
	Wire creep
	Wire burn-back
	Gas pre-flows
	Gas post-flows
	Non-latched
	Special, non-latched
	Latched
	Special, latched
t	Time
P _{START}	Ignition program
P _A	Main program
P _B	Reduced main program
P _{END}	End program
t ₂	Spot time

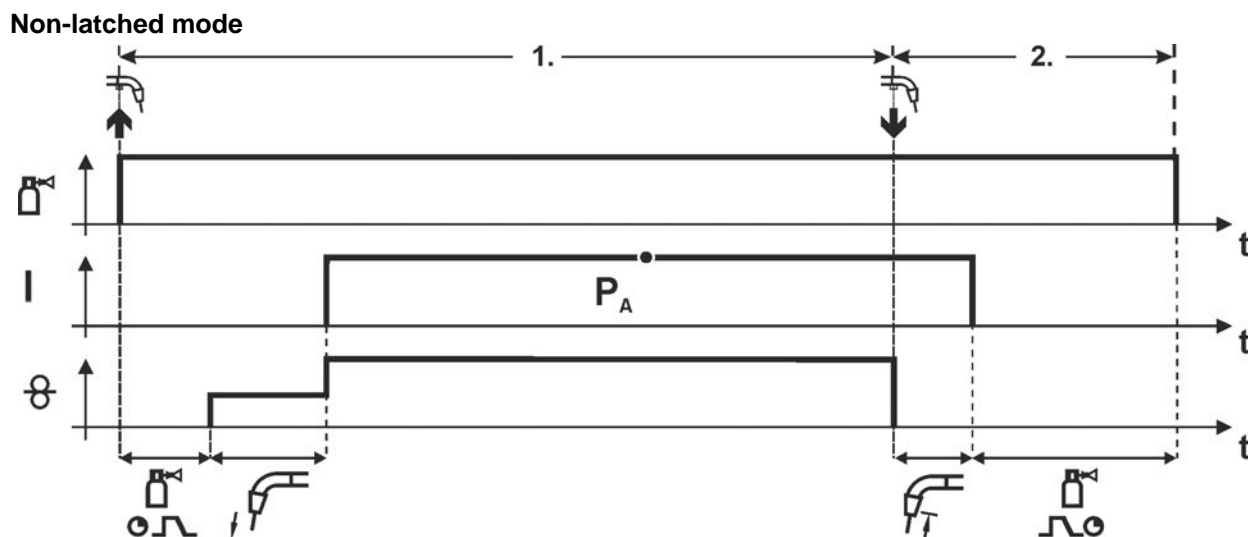

Figure 5-20

Step 1

- Press and hold torch trigger.
- Shielding gas is expelled (gas pre-flows).
- Wire feed motor runs at “creep speed”.
- Arc ignites after the wire electrode makes contact with the workpiece; welding current flows.
- Change over to pre-selected wire speed.

Step 2

- Release torch trigger.
- WF motor stops.
- Arc is extinguished after the preselected wire burn-back time expires.
- Gas post-flow time elapses.

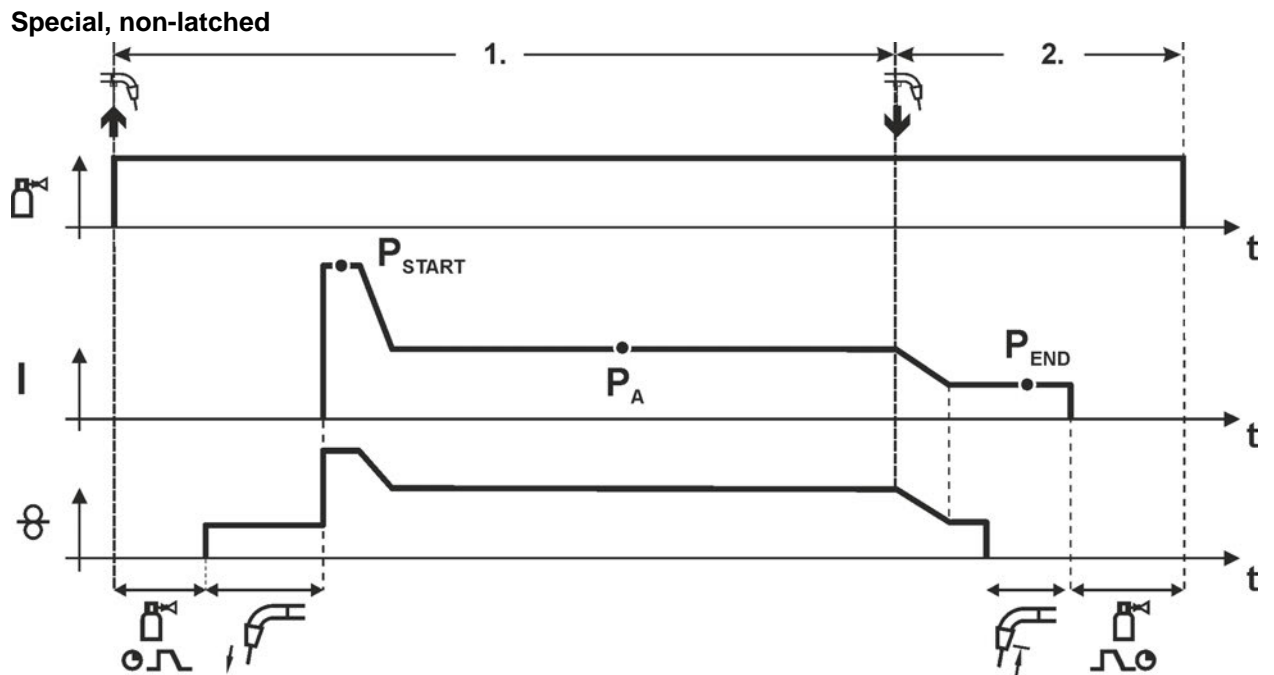

Figure 5-21

Step 1

- Press and hold torch trigger
- Shielding gas is expelled (gas pre-flows)
- Wire feed motor runs at "creep speed".
- Arc ignites after the wire electrode makes contact with the workpiece, welding current is flowing (start program P_{START} for the time t_{start})
- Slope to main program P_A .

Step 2

- Release torch trigger
- Slope to end program P_{END} for the time t_{end} .
- WF motor stops.
- Arc is extinguished after the preselected wire burn-back time expires.
- Gas post-flow time elapses.

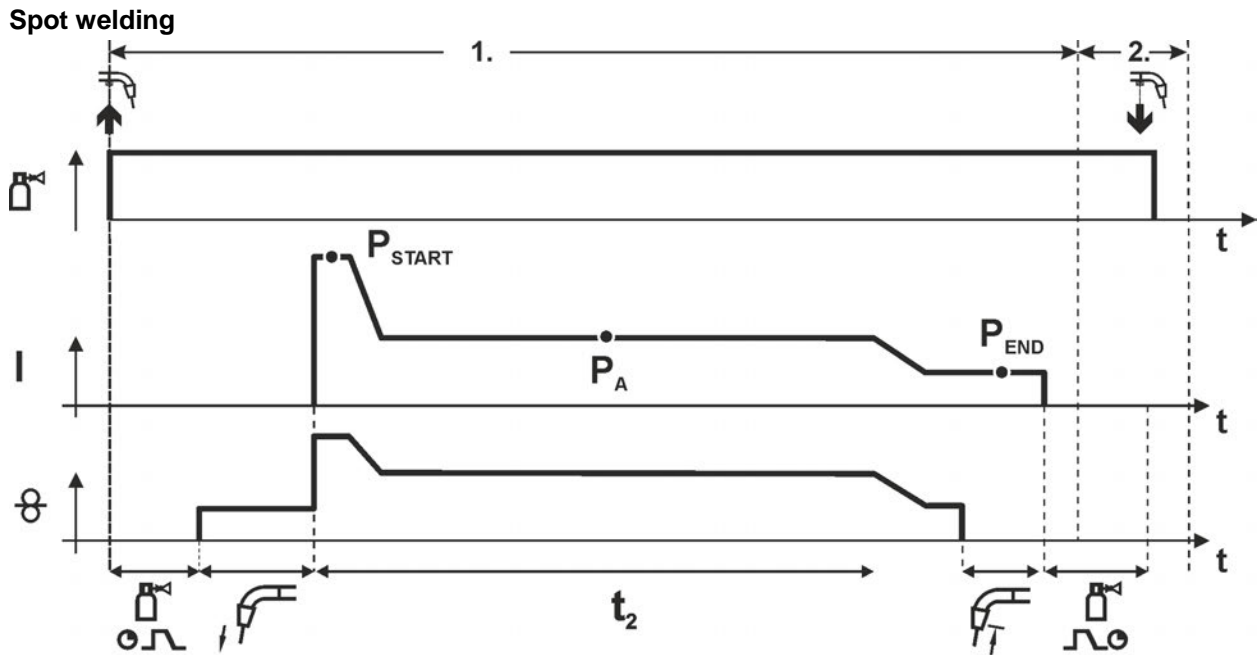

Figure 5-22

The ignition time t_{start} must be added to the spot time t_2 .

1st cycle

- Press and hold torch trigger
- Shielding gas is expelled (gas pre-flows)
- Wire feed motor runs at "creep speed"
- Arc ignites after the wire electrode makes contact with the workpiece, welding current is flowing (start program P_{START} , spot time starts)
- Slope to main program P_A
- After the set spot time elapses, slope goes to end program P_{END} .
- Wire feed motor stop welding.
- Arc is extinguished after the pre-selected wire burn-back time elapses
- Gas post-flow time elapses.

2nd cycle

- Release torch trigger

Releasing the torch trigger (step 2) interrupts the welding process even if the spot time has not yet elapsed (slope to end program P_{END}).

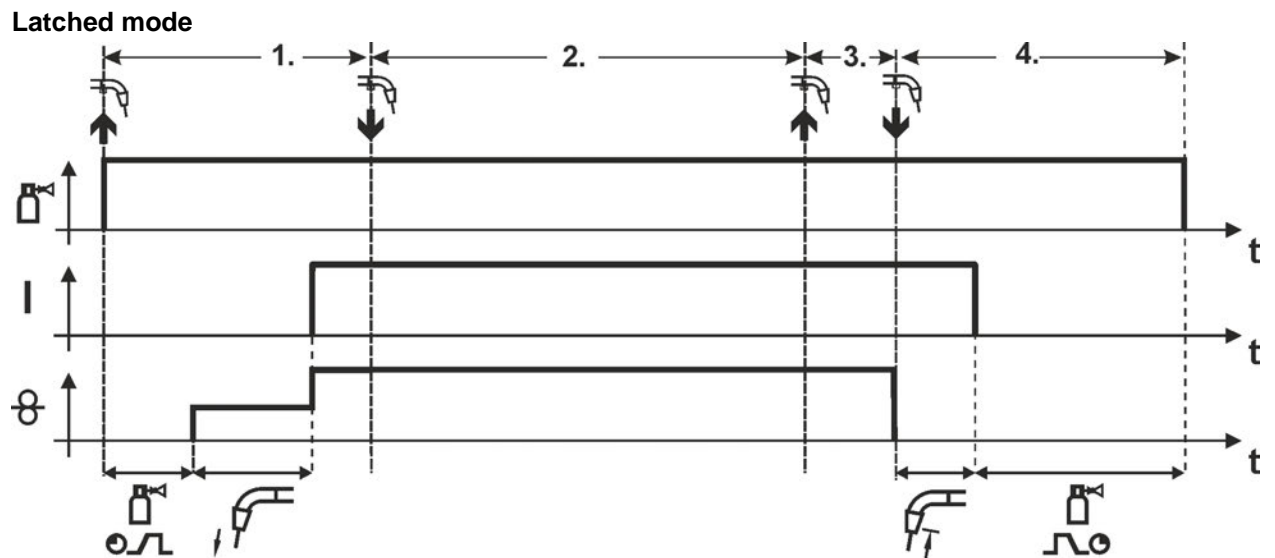

Figure 5-23

Step 1

- Press and hold torch trigger
- Shielding gas is expelled (gas pre-flows)
- Wire feed motor runs at "creep speed".
- Arc ignites after the wire electrode makes contact with the workpiece; welding current flows.
- Change over to pre-selected WF speed (main program P_A).

Step 2

- Release torch trigger (no effect)

Step 3

- Press torch trigger (no effect)

Step 4

- Release torch trigger
- WF motor stops.
- Arc is extinguished after the preselected wire burn-back time expires.
- Gas post-flow time elapses.

Latched special

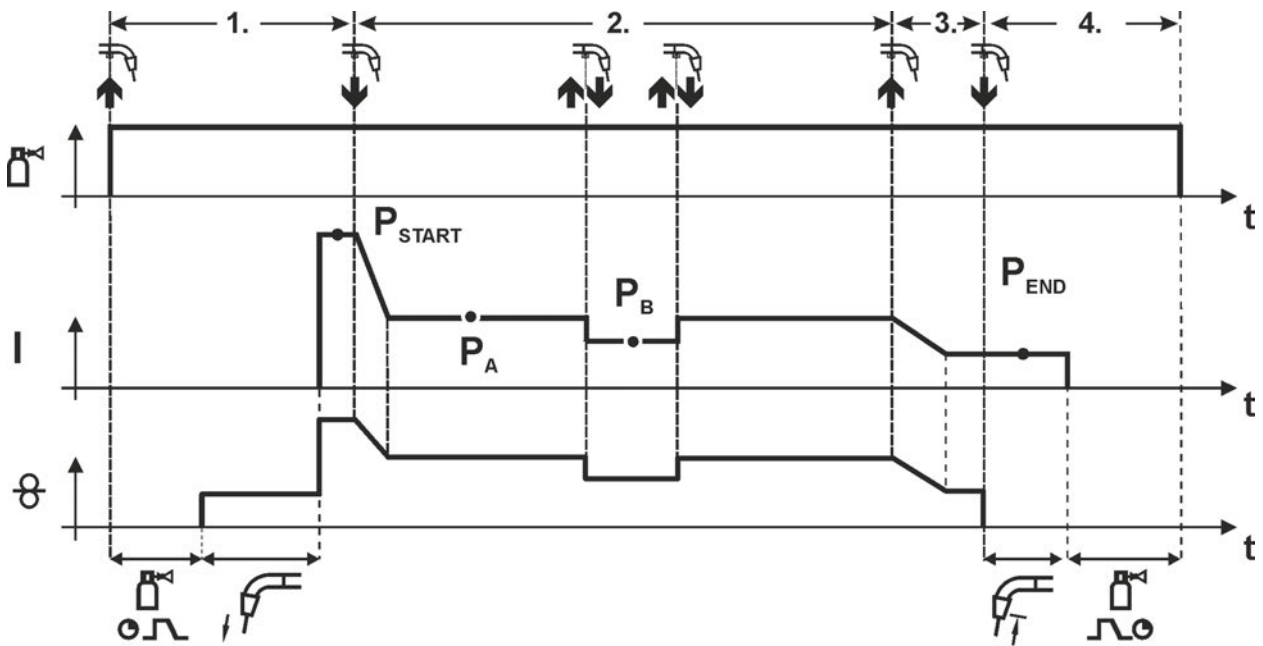

Figure 5-24

Step 1

- Press and hold torch trigger
- Shielding gas is expelled (gas pre-flows)
- Wire feed motor runs at “creep speed”.
- Arc ignites after the wire electrode makes contact with the workpiece, welding current is flowing (start program P_{START})

Step 2

- Release torch trigger
- Slope to main program P_A .

The slope on main program P_A is given at the earliest after the set time t_{START} elapses and at the latest when the torch trigger is released.

Tapping¹⁾ can be used to change over to the reduced main program P_B .

Repeated tapping will switch back to the main program P_A .

Step 3

- Press and hold torch trigger
- Slope to end program P_{END} .

Step 4

- Release torch trigger
- WF motor stops.
- Arc is extinguished after the preselected wire burn-back time expires.
- Gas post-flow time elapses.



¹⁾ Prevent tapping (brief press and release within 0.3 seconds)

If the welding current is to be prevented from switching over to the reduced main program P_B by tapping, the parameter value for WF3 needs to be set to 100% ($P_A = P_B$) in the program sequence.

5.10.7 MIG/MAG program sequence ("Program steps" mode)

Certain materials, such as aluminium, require special functions in order to be able to weld them safely and at high quality. The latched special operating mode is used here with the following programs:

- Start program P_{START} (reduction of cool points at the start of the seam)
- Main program P_A (continuous welding)
- Reduced main program P_B (targeted heat reduction)
- End program P_{END} (minimisation of end craters via targeted heat reduction)

The programs include the parameters wire speed (operating point), arc length correction, slope times, program duration, etc.

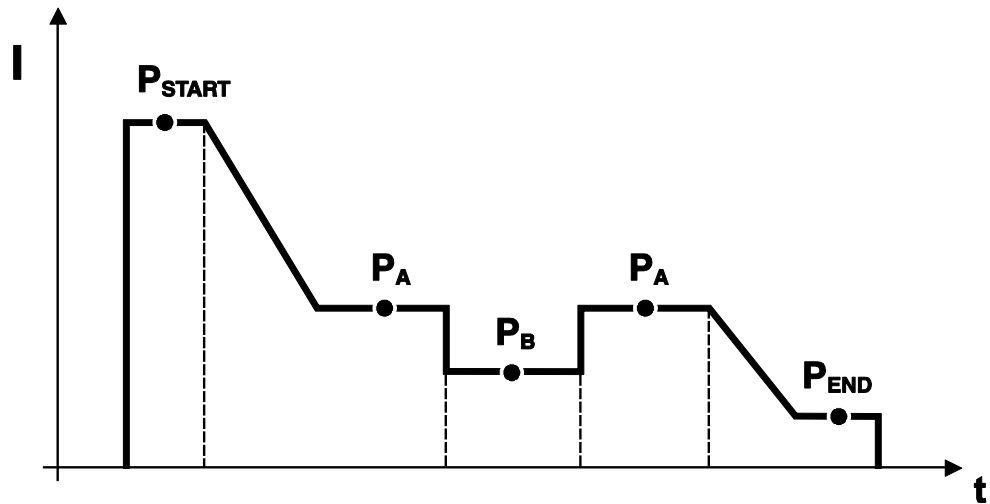

Figure 5-25



***This function can only be enabled with the PC300.NET software.
(See operating instructions for the software)***

5.10.7.1 Example, tack welding (non-latched)

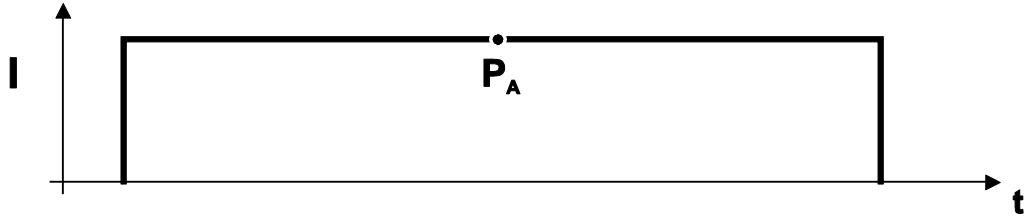

Figure 5-26

5.10.7.2 Example, aluminium tack welding (non-latched special)

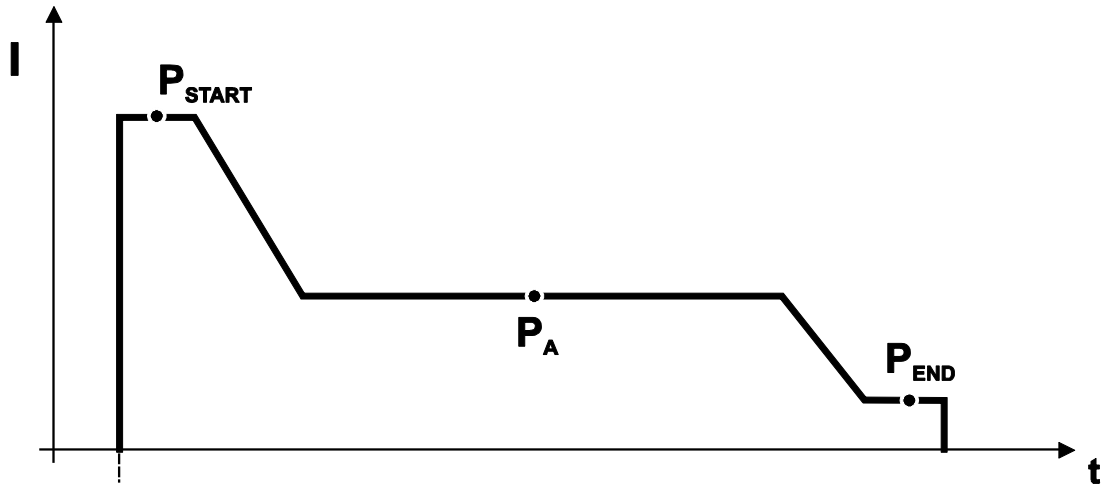

Figure 5-27

5.10.7.3 Example, aluminium welding (latched special)

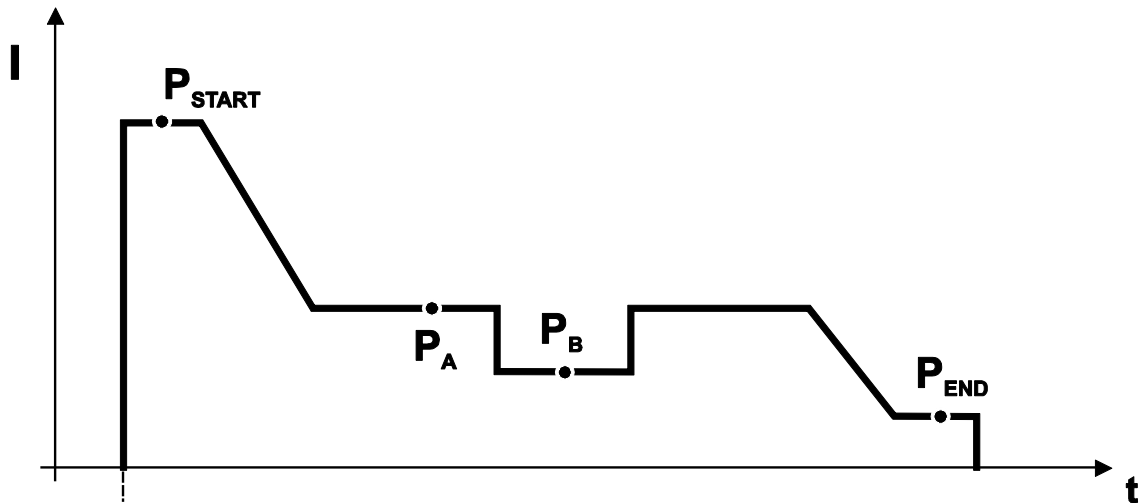

Figure 5-28

5.10.8 Main program A mode

Different welding tasks or positions on a workpiece demand various welding performances (operating points) or welding programs. The following parameters are stored in each of the up to 16 programs:

- Operating mode
- Welding type
- Wire feed speed (DV2)
- Voltage correction (U2)
- Dynamics (DYN2)

The user can change the main program welding parameters using the following components.

	Program switching	JOB switching	Program	Operating mode	Wire speed	Voltage correction	Dynamics
M3.7x Wire feeder control	Yes	Yes	P0	Yes	Yes	Yes	
			P1...15		Yes		
R20 Remote control	Yes	No	P0	No	Yes		No
			P1...9		Yes ¹⁾		
R40 Remote control	Yes	No	P0	No	Yes		No
					No		
R50 Remote control	Yes	No	P0	Yes	Yes		
			P1...15				
PC 300.NET Software	No	No	P0	Yes	No		
			P1...15		Yes		
Up/Down Welding torch	Yes	No	P0	No	Yes	No	
			P1...9		No		
2 Up/Down Welding torch	Yes	No	P0	No	Yes		No
			P1...15		No		
PC 1 Welding torch	Yes	No	P0	No	Yes	No	
			P1...15		No		
PC 2 Welding torch	Yes	Yes	P0	No	Yes		No
			P1...15		No		

Example 1: Welding workpieces with different sheet metal thicknesses (non-latched)

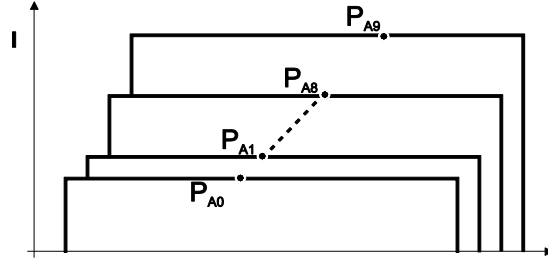

Figure 5-29

Example 2: Welding different positions on a workpiece (latched)

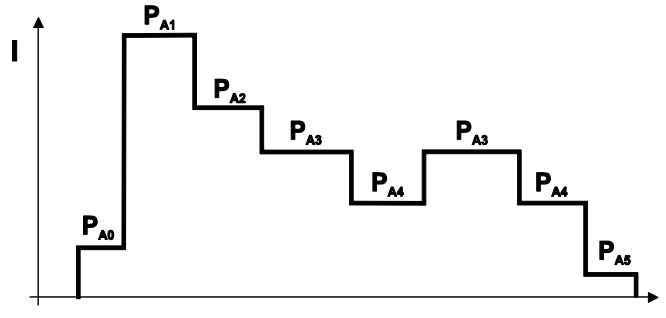

Figure 5-30

Example 3: Aluminium welding of different sheet metal thicknesses (non-latched or latched special)

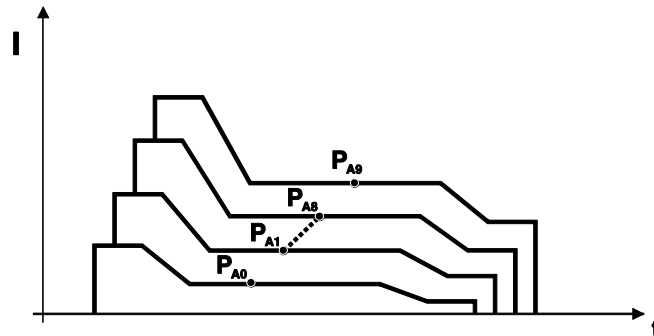

Figure 5-31



Up to 16 programs (P_{A0} to P_{A15}) can be defined.

An operating point (wire speed, arc length correction, dynamics/choke effect) can be defined permanently in each program.

Program P_0 is an exception: the settings for operating points are made manually here.

Changes to the welding parameters are saved immediately!

5.10.9 MIG/MAG automatic cut-out



The welding machine ends the ignition process or the welding process with an

- ignition fault (no welding current flows within 5 s after the start signal)
- arc interruption (arc is interrupted for longer than 5 s)

5.10.10 Standard MIG/MAG torch

The MIG welding torch trigger is essentially used to start and stop the welding process.

Operating elements	Functions
 Torch trigger	<ul style="list-style-type: none"> Start/stop welding

Other functions are also possible by tapping the torch trigger, depending on the machine type and control configuration > see 5.17 chapter:

- Change over between welding programs (P8).
- Program selection before starting welding (P17).
- Switching between wire feed units in dual operation mode (P10).

5.10.11 MIG/MAG special-torches

Function specifications and more indepth information can be found in the operating manual for the relevant welding torch!

5.10.11.1 Program- and Up- / down operation

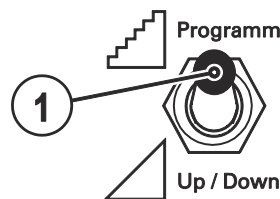



Figure 5-32

Item	Symbol	Description
1		Welding torch function changeover switch (special welding torch required) Changing over programs or JOBS Infinite adjustment of welding performance.

5.10.11.2 Switching between Push/Pull and intermediate drive

DANGER



Do not carry out any unauthorised repairs or modifications!

To avoid injury and equipment damage, the unit must only be repaired or modified by specialist, skilled persons!

The warranty becomes null and void in the event of unauthorised interference.

- Appoint only skilled persons for repair work (trained service personnel)!



Test!

Before re-commissioning, it is essential that an "inspection and test during operation" is carried out conforming to IEC / DIN EN 60974-4 "Arc welding devices - inspection and testing during operation"!

- **For detailed instructions, please see the standard operating instructions for the welding machine.**

The plugs are located directly on the M3.7x printed circuit board.

Plug	Function
on X24	Operation with Push/Pull welding torch (factory setting)
on X23	Operation with intermediate drive

5.11 TIG welding

5.11.1 Welding torch and workpiece line connection

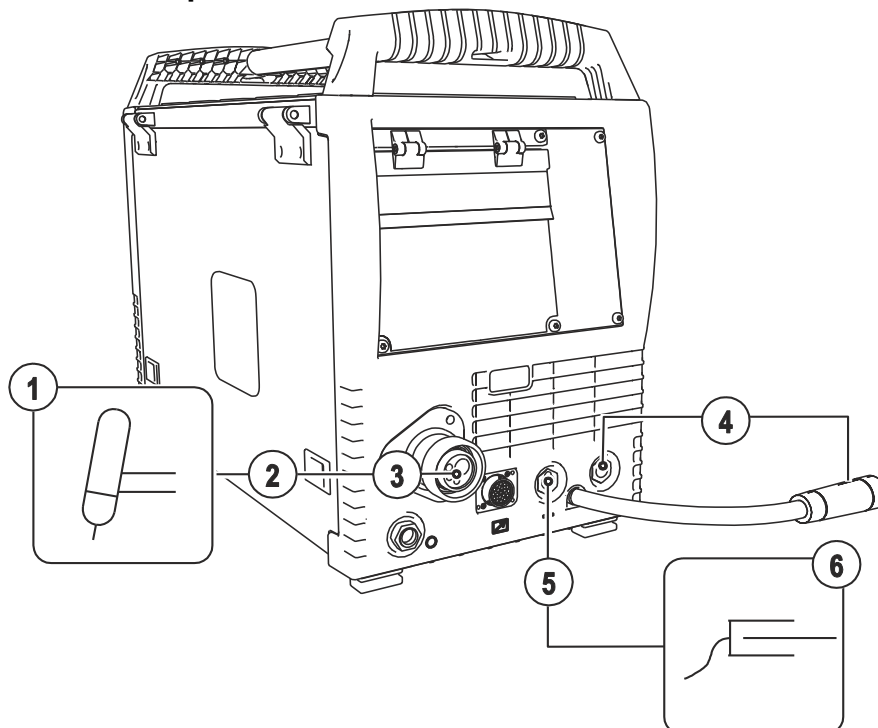

Figure 5-33

Item	Symbol	Description
1		Welding torch
2		Welding torch hose package
3		Welding torch connection (Euro or Dinse torch connector) Welding current, shielding gas and torch trigger integrated
4		Welding current cable, polarity selection Welding current to the central connector/torch, enables polarity selection. • TIG: Connection socket for "-" welding current
5		Connection socket, "+" welding current • TIG welding: Workpiece connection
6		Workpiece

- Insert the central plug for the welding torch into the central connector and screw together with crown nut.
 - Insert the cable plug on the work piece lead into the "+" welding current connection socket and lock by turning to the right.
 - Welding current lead, insert polarity selection into the "-" welding current connection socket and lock.
- If fitted:
- Lock connecting nipples of the cooling water tubes into the corresponding quick connect couplings: Return line red to quick connect coupling, red (coolant return) and supply line blue to quick connect coupling, blue (coolant supply).

5.11.2 Welding task selection

- Select JOB 127 (TIG welding task).

It is only possible to change the JOB number when no welding current is flowing.

Operating element	Action	Result	Display
	1 x	Select JOB number input	
		Set the JOB number The machine adopts the required setting after approx. 3 seconds	

5.11.3 Welding current setting

The welding current is normally set using the "Wire speed" rotary dial.

Operating element	Action	Result	Displays
		Welding current is set	Setpoint setting

5.11.4 TIG arc ignition

5.11.4.1 Liftarc

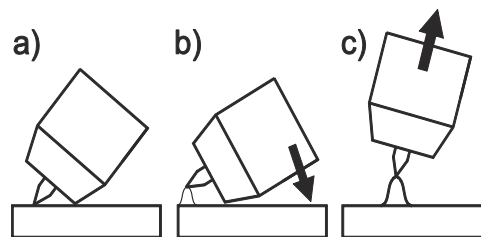

Figure 5-34











The arc is ignited on contact with the workpiece:

- Carefully place the torch gas nozzle and tungsten electrode tip onto the workpiece and press the torch trigger (liftarc current flowing, regardless of the main current set).
- Incline the torch over the torch gas nozzle to produce a gap of approx. 2-3 mm between the electrode tip and the workpiece. The arc ignites and the welding current is increased, depending on the operating mode set, to the ignition or main current set.
- Lift off the torch and swivel to the normal position.

Ending the welding process: Release or press the torch trigger depending on the operating mode selected.

5.11.5 Function sequences/operating modes

5.11.5.1 Explanation of signs and functions

Symbol	Meaning
	Press torch trigger
	Release torch trigger
	Tap torch trigger (press briefly and release)
	Shielding gas flowing
I	Welding output
	Gas pre-flows
	Gas post-flows
	Non-latched
	Special, non-latched
	Latched
	Special, latched
t	Time
P _{START}	Ignition program
P _A	Main program
P _B	Reduced main program
P _{END}	End program
tS1	Slope duration from P _{START} to P _A

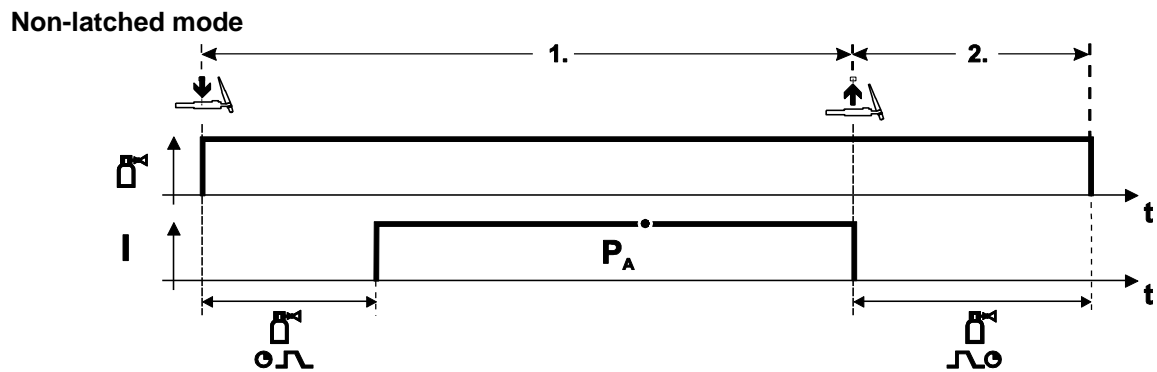

Figure 5-35

Selection

- Select non-latched operating mode

Step 1

- Press and hold torch trigger.
- Shielding gas is expelled (gas pre-flows).

The arc is ignited using liftarc.

- Welding current flows with pre-selected setting.

Step 2

- Release torch trigger.
- Arc is extinguished.
- Gas post-flow time elapses.

Special, non-latched

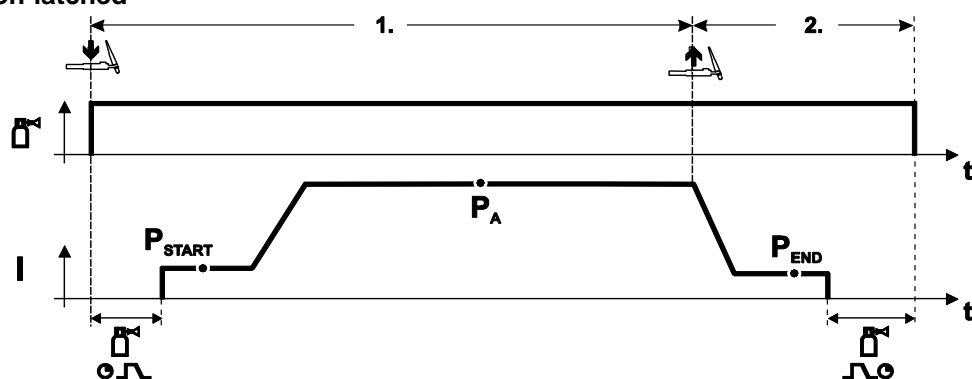

Figure 5-36

Selection

- Select non-latched special mode

Step 1

- Press and hold torch trigger
- Shielding gas is expelled (gas pre-flows)

The arc is ignited using liftarc.

- Welding gas flows with pre-selected setting in start program "P_{START}".
- After the "t_{start}" ignition current time elapses, the welding current rises with the set upslope time "t_{S1}" to the main program "P_A".

Step 2

- Release torch trigger.
- The welding current reduces with the downslope time "t_{Se}" to the end program "P_{END}".
- After the end current time "end" elapses, the arc will extinguish.
- Gas post-flow time elapses.

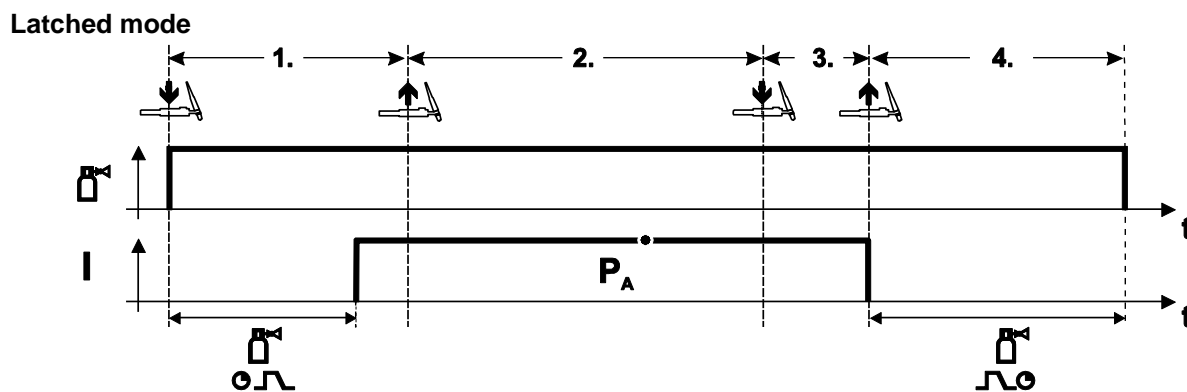



Figure 5-37

Selection

- Select latched operating mode 

Step 1

- Press and hold torch trigger
- Shielding gas is expelled (gas pre-flows)

The arc is ignited using liftarc.

- Welding current flows with pre-selected setting.

Step 2

- Release torch trigger (no effect)

Step 3

- Press torch trigger (no effect)

Step 4

- Release torch trigger
- Arc is extinguished.
- Gas post-flow time elapses.

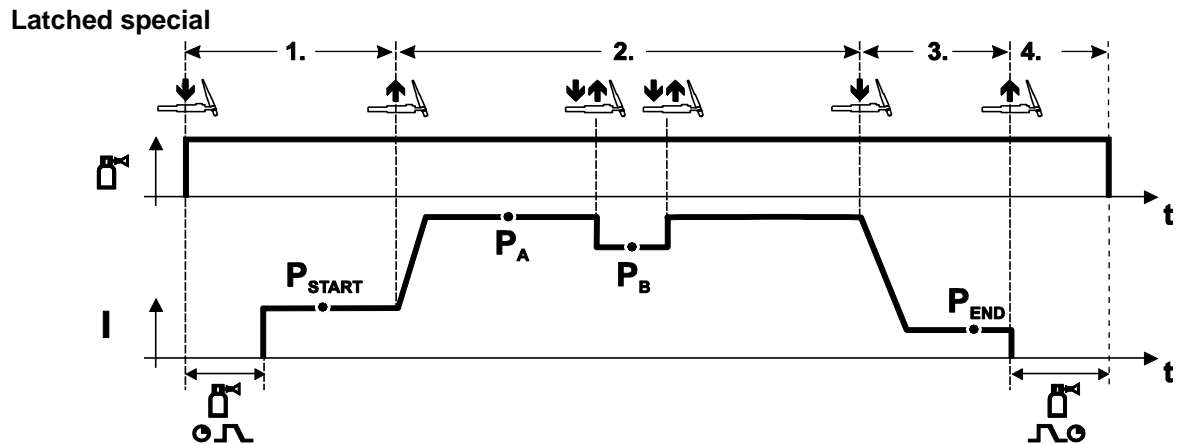



Figure 5-38

Selection

- Select latched special mode .

Step 1

- Press and hold torch trigger.
- Shielding gas is expelled (gas pre-flows).

The arc is ignited using liftarc.

- Welding gas flows at pre-selected setting in start program " P_{START} ".

Step 2

- Release torch trigger.
- Slope on main program " P_A ".

The slope on main program P_A is given at the earliest after the set time t_{START} elapses and at the latest when the torch trigger is released.

Tapping can be used to switch to the reduced main program " P_B ". Repeated tapping will switch back to the main program " P_A ".

Step 3

- Press the torch trigger.
- Slope to end program " P_{END} ".

Step 4

- Release torch trigger.
- Arc is extinguished.
- Gas post-flow time elapses.

5.11.6 TIG automatic cut-out

The welding machine ends the ignition process or the welding process with an

- ignition fault (no welding current flows within 5 s after the start signal)
- arc interruption (arc is interrupted for longer than 5 s)

5.12 MMA welding

⚠ CAUTION



Risk of being crushed or burnt.

When replacing spent or new stick electrodes

- Switch off machine at the main switch
- Wear appropriate safety gloves
- Use insulated tongs to remove spent stick electrodes or to move welded workpieces and
- Always put the electrode holder down on an insulated surface.

5.12.1 Connecting the electrode holder and workpiece lead

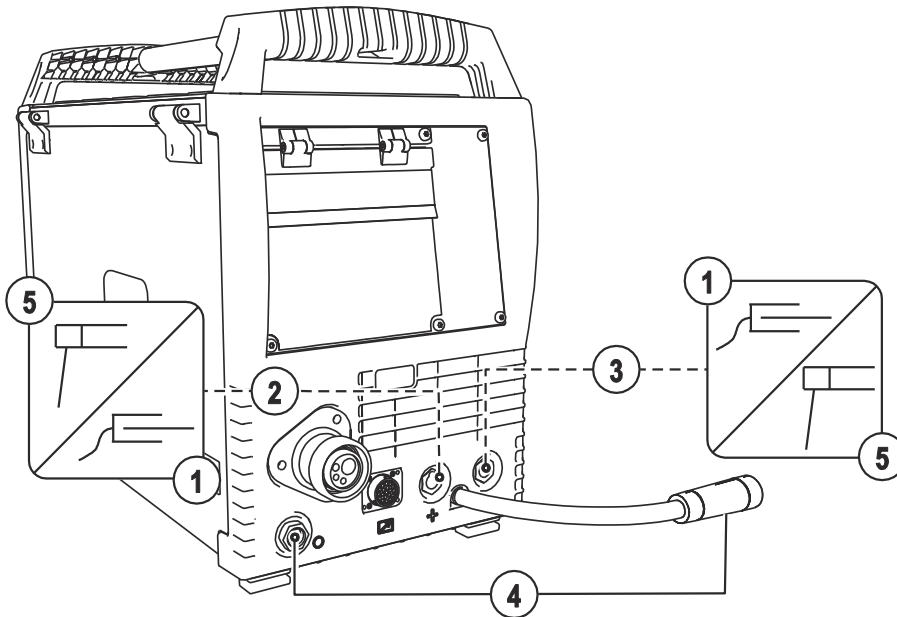

Figure 5-39

Item	Symbol	Description
1		Workpiece
2		Connection socket, "+" welding current • MMA welding: Workpiece connection
3		"-" welding current connection socket • MMA welding: electrode holder connection
4		Park socket, polarity selection plug Retainer for the polarity selection plug in MMA mode or for transport.
5		Electrode holder

- Insert cable plug of the electrode holder into either the "+" or "-" welding current connection socket and lock by turning to the right.
- Insert cable plug of the workpiece lead into either the "+" or "-" welding current connection socket and lock by turning to the right.
- Insert the polarity selection plug in the park socket and lock in place by turning to the right.



Polarity depends on the instructions from the electrode manufacturer given on the electrode packaging.

5.12.2 Welding task selection

- Select JOB 128 (MMA welding task).

It is only possible to change the JOB number when no welding current is flowing.

Operating element	Action	Result	Display
	1 x	Select JOB number input	
		Set the JOB number The machine adopts the required setting after approx. 3 seconds	

5.12.3 Welding current setting

The welding current is normally set using the "Wire speed" rotary dial.

Operating element	Action	Result	Displays
		Welding current is set	Setpoint setting

5.12.4 Arcforce

Operating element	Action	Result	Display
		Select arcforcing welding parameter LED for the button ● is on.	
		Arcforcing setting for electrode types: (Setting range -40 to 40) Negative values Rutile Values around zero Basic Positive values Cellulose	

5.12.5 Hotstart

The hotstart device improves the ignition of the stick electrodes using an increased ignition current.

- a) = Hotstart time
- b) = Hotstart current
- I = Welding current
- t = Time

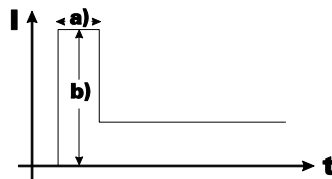
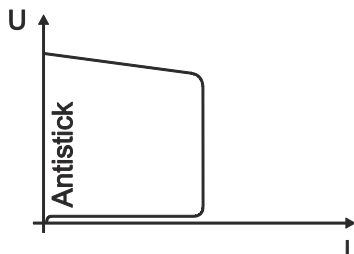

Figure 5-40

5.12.6 Antistick





Anti-stick prevents the electrode from annealing.

If the electrode sticks in spite of the Arcforce device, the machine automatically switches over to the minimum current within about 1 second to prevent the electrode from overheating. Check the welding current setting and correct according to the welding task!

Figure 5-41

5.13 Remote control

-  **The manufacturer's warranty becomes void if non-genuine parts are used!**
 - **Only use system components and options (power sources, welding torches, electrode holders, remote controls, spare parts and replacement parts, etc.) from our range of products!**
 - **Only insert and lock accessory components into the relevant connection socket when the machine is switched off.**
-  **The remote controls are operated on the 19-pole remote control connection socket (analogue).**
-  **Please note the relevant documentation of the accessory components.**

5.14 Interfaces for automation

DANGER



Do not carry out any unauthorised repairs or modifications!
To avoid injury and equipment damage, the unit must only be repaired or modified by specialist, skilled persons!
The warranty becomes null and void in the event of unauthorised interference.

- **Appoint only skilled persons for repair work (trained service personnel)!**

-  **Accessory components and the power source itself can be damaged by incorrect connection!**
 - **Only insert and lock accessory components into the relevant connection socket when the machine is switched off.**
 - **Comprehensive descriptions can be found in the operating instructions for the relevant accessory components.**
 - **Accessory components are detected automatically after the power source is switched on.**

5.14.1 Remote control connection socket, 19-pole

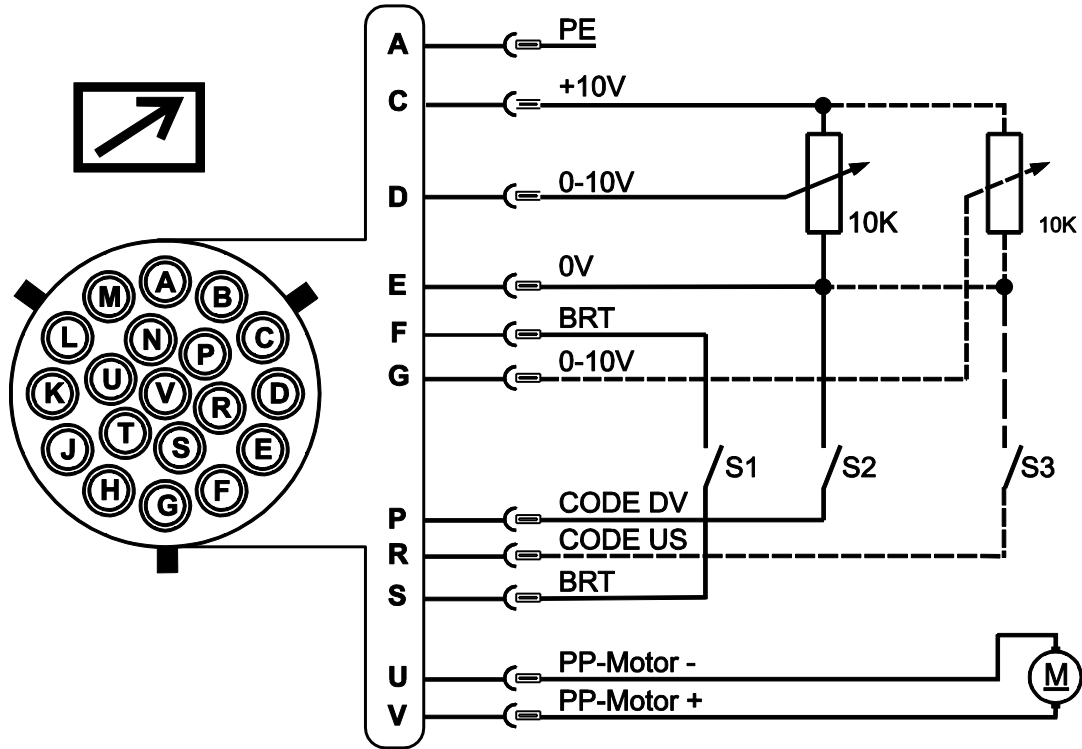

Figure 5-42

Pin	Signal form	Short description
A	Output	Connection for PE cable screen
C	Output	Reference voltage for potentiometer 10 V (max. 10 mA)
D	Input	Control voltage specification (0 V–10 V) – wire feed speed
E	Output	Reference potential (0 V)
F/S	Input	Welding power start/stop (S1)
G	Input	Control voltage specification (0 V–10 V) – arc length correction
P	Input	Activation of control voltage specification for wire feed speed (S2) For activation, put signal to reference potential 0 V (pin E)
R	Input	Activation of control voltage specification for arc length correction (S3) For activation, put signal to reference potential 0 V (pin E)
U/V	Output	Supply voltage push/pull welding torch

5.15 PC Interfaces



Equipment damage or faults may occur if the PC is connected incorrectly!
Not using the SECINT X10USB interface results in equipment damage or faults in signal transmission. The PC may be destroyed due to high frequency ignition pulses.

- **Interface SECINT X10USB must be connected between the PC and the welding machine!**
- **The connection must only be made using the cables supplied (do not use any additional extension cables)!**

PC 300 welding parameter software

Create all welding parameters quickly on the PC and easily transfer them to one or more welding machines (accessories: set consisting of software, interface, connection leads).

Q-DOC 9000 welding data documentation software

(Accessories: set consisting of software, interface, connection leads)

The ideal tool for welding data documentation of, for example: welding voltage and current, wire speed and motor current.

WELDQAS welding data monitoring and documentation system

Network-compatible welding data monitoring and documentation system for digital machines

5.16 Access control



The key switch is only available for machines which are fitted with the "OW KL XX5" option ex works.

To protect against unauthorised or unintentional adjustment of the welding parameters on the machine, the control input can be locked with the aid of a key switch.

In key switch position 1 all functions and parameters can be set without restriction.

In key switch position 0 the following functions and parameters cannot be changed:

- No adjustment of the operating point (welding performance) in programs 1–15.
- No change of welding or operating mode in programs 1–15.
- The welding parameters can be displayed but not changed in the control's function sequence.
- No welding task switching (JOB block operation P16 possible).
- No change of special parameters (except P10). Restart required.

5.17 Special parameters (advanced settings)

Special parameters (P1 to Pn) are applied for customer-specific configuration of machine functions. This allows the user maximum flexibility in optimising their requirements.

These settings are not configured directly on the machine control since a regular setting of the parameters is generally not required. The number of selectable special parameters can deviate between the machine controls used in the welding system (also see the relevant standard operating instructions).

If required, the special parameters can be reset to the factory settings > see 7.3 chapter.

5.17.1 Selecting, changing and saving parameters

ENTER (Enter the menu)

- Switch off machine at the main switch.
- Press and hold the "left parameter selection" button and switch the machine on again at the same time.

NAVIGATION (Navigate the menu)

- Select parameters by turning the "welding parameter setting" rotary dial.
- Set or change the parameters by turning the "arc length correction/select welding program" rotary dial.

EXIT (Exit the menu)

- Press the "right parameter selection" button (switch machine off and on again).

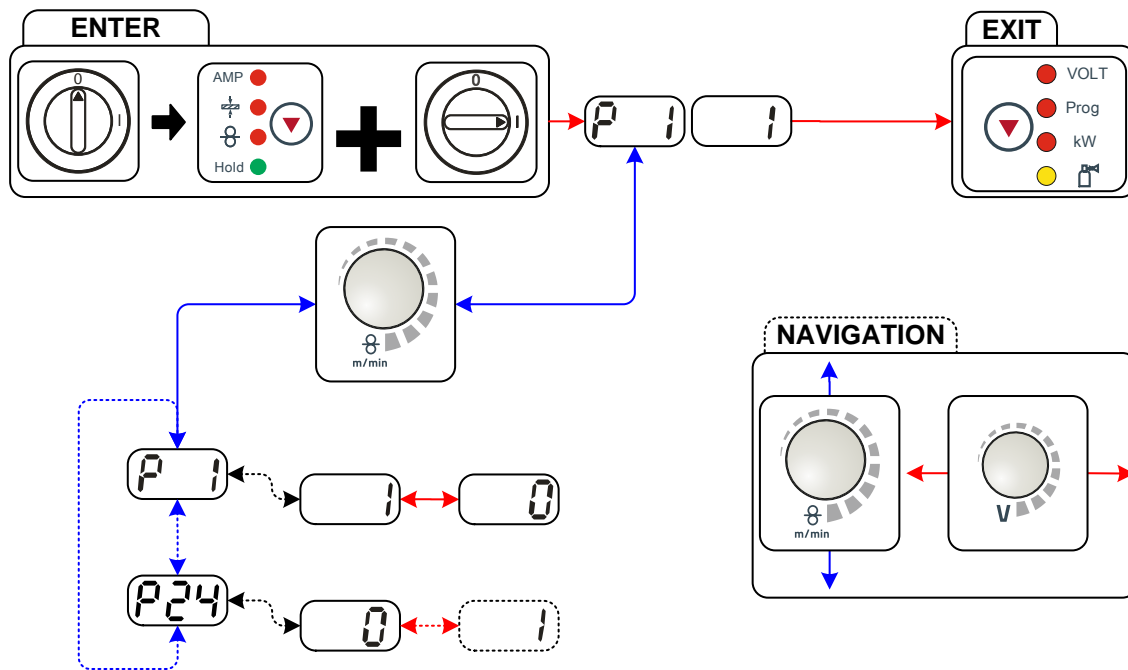



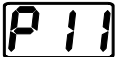
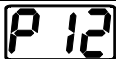

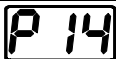
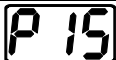
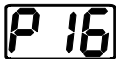
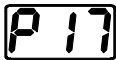

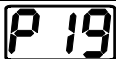



Figure 5-43

Display	Setting/selection
P 1	Ramp time for wire inching 0 = ----- normal inching (10s ramp time) 1 = ----- fast inching (3s ramp time) (Ex works)
P 2	Block program "0" 0 = ----- P0 enabled (Ex works) 1 = ----- P0 blocked
P 3	Display mode for Up/Down welding torch with one-digit 7-segment display (two keys) 0 = ----- normal display (ex works) program number/welding power (0–9) 1 = ----- display toggles between program number/welding type
P 4	Program limitation Programs 1 to max. 15 Ex works: 15
P 5	Special cycle in the special latched and non-latched operating modes 0 = ----- normal (previous) non-latched/latched (Ex works) 1 = ----- WF3 cycle for non-latched/latched
P 6	Enable special jobs SP1 to SP3 0 = ----- no enabling (Ex works) 1 = ----- enabling of Sp1-3

Display	Setting/selection
	Correction operation, threshold value setting 0 =-----correction operation switched off (Ex works) 1 =-----correction operation on "Main program (PA)" flashing
	Program changeover with standard torch 0 =-----no program changeover (Ex works) 1 =-----special latched 2 =-----specific latched special (n cycle active)
	Lat. and sp. lat. tapping start 0 =-----no latched tapping start (Ex works) 1 =-----latched tapping start possible
	One or two-wire feed operation 0 =-----single operation (Ex works) 1 =-----dual operation, this unit is the "master" 2 =-----dual operation, this unit is the "slave"
	Special latched tapping time 0 = tapping function switched off 1 = 300ms (Ex works) 2 = 600ms
	JOB list changeover 0 =-----task-oriented JOB list 1 =-----actual JOB list (Ex works) 2 =-----actual JOB list, JOB changeover activated via accessories
	Lower limit remote JOB changeover Lowest JOB that can be selected using PowerControl 2 torches. Lower limit: 129 (Ex works)
	Upper limit remote JOB changeover JOB range of the POWERCONTROL2 torch Upper limit: 169 (Ex works)
	HOLD function 0 =-----HOLD values are not displayed 1 =-----HOLD values are displayed (Ex works)
	Block JOB mode 0 =-----Block JOB mode not enabled (Ex works) 1 =-----Block JOB mode enabled
	Program selection with standard torch trigger 0 =-----no program selection (Ex works) 1 =-----program selection possible
	Switching the operating mode and welding type using the wire feed control 0 =-----Switching the operating mode and welding type using the wire feed control and program 0 (factory setting). 1 =-----Switching the operating mode and welding type using the wire feed control and programs 0-15.
	Mean value display for superPuls 0 =-----Function switched off. 1 =-----Function switched on (ex factory).
	Predefined pulse arc welding process in the PA program 0 =-----Predefined pulse arc welding process in the PA program is disabled. 1 =-----If the superPuls and welding process switching functions are available and activated, the pulse arc welding process is always executed in the main program PA (ex factory).

Display	Setting/selection
	Predefined absolute value for relative programs Start program (P_{START}), down-slope program (P_B) and end program (P_{END}) can be set relative to the main program (P_A) or in an absolute manner, as desired. 0 = ----- Relative parameter setting (ex factory) 1 = ----- Absolute parameter setting
	Electronic gas flow control, type 1 = ----- type A (ex works) 0 = ----- type B
	Program settings for relative programs 0 = ----- Combined setting of relative programs possible (ex works). 1 = ----- Individual setting of relative programs possible (ex works).
	Correction or nominal voltage display 0 = ----- Correction voltage display (ex works). 1 = ----- Absolute nominal voltage display.

5.17.1.1 Reset to factory settings

All special parameters saved by the user will be overwritten by the factory settings!

Operating element	Action	Result
		Switch off welding machine
		Keep the button pressed
		Switch on welding machine
		Release the button, wait about 3 seconds
		Switch off welding machine and restart in order to put the changes into effect

5.17.1.2 Special parameters in detail

Ramp time for wire inching (P1)

The wire inching starts with a speed 1.0 m/min for 2 secs. It is subsequently increased to a ramp function to 6.0 m/min. The ramp time can be set between two ranges.

During wire inching, the speed can be changed by means of the welding parameter setting rotary dial. Changing the speed has no effect on the ramp time.

Program "0", releasing the program block (P2)

The program P0 (manual setting) is blocked. Only operation with P1-P15 is possible, irrespective of the key switch position.

Display mode for Up/Down welding torch with one-digit 7-segment display (P3)

Normal display:

- Program mode: Program number
- Up/down operation: Welding power (0=minimum current/9=maximum current)

Toggling display:

- Program mode: Program number and welding procedure (P=pulse/n=not pulse) are toggled
- Up/down operation: Welding power (0=minimum current/9=maximum current) and symbol for up/down operation are toggled

Program limit (P4)

Program selection can be limited with the special parameter P4.

- The setting is adopted for all JOBs.
- Program selection depends on the position of the "welding torch function" changeover switch (*> see 4.2.1 chapter*).

Programs can only be switched when the changeover switch is in the "program" position.

- Programs can be switched by means of a connected remote control or special welding torch.
- If a special welding torch or a remote control is not connected, it is only possible to switch programs by means of the "arc length correction/select welding program" rotary dial (*> see 4.3 chapter*).

Special cycle in the operating modes special latched and non-latched (P5)

With the special sequence activated, the start of the welding process changes as follows:

Sequence for special non-latched mode/special latched mode:

- Start program "P_{START}"
- Main program "P_A"

Sequence for special non-latched mode/special latched mode with custom sequence activated:

- Start program "P_{START}"
- Reduced main program "P_B"
- Main program "P_A"

Enabling special JOBs SP1 to SP3 (P6)

Phoenix Expert machine series:

The welding task is set at the power source control; refer to the relevant system documentation.

If required, the predefined special welding tasks SP1 = JOB 129 / SP2 = JOB130 / SP3 = JOB 131 only can be selected at the wire feeder control. The special JOBs are selected by pressing the welding task selection push-button for a longer period. The special JOBs are switched by pressing the push-button briefly.

The JOB changeover is blocked if the key switch is in the "0" position.

This block can be cancelled for the special JOBs (SP1 - SP3).

Correction operation, threshold value setting (P7)

The correction operation is switched on and off for all JOBS and their programs at the same time. A correction operation is specified for wire speed (DV) and welding voltage correction (Ukorr) for each JOB. The correction value is saved separately for each program. The correction range can be maximum 30% of the wire speed and +/-9.9 V welding voltage.

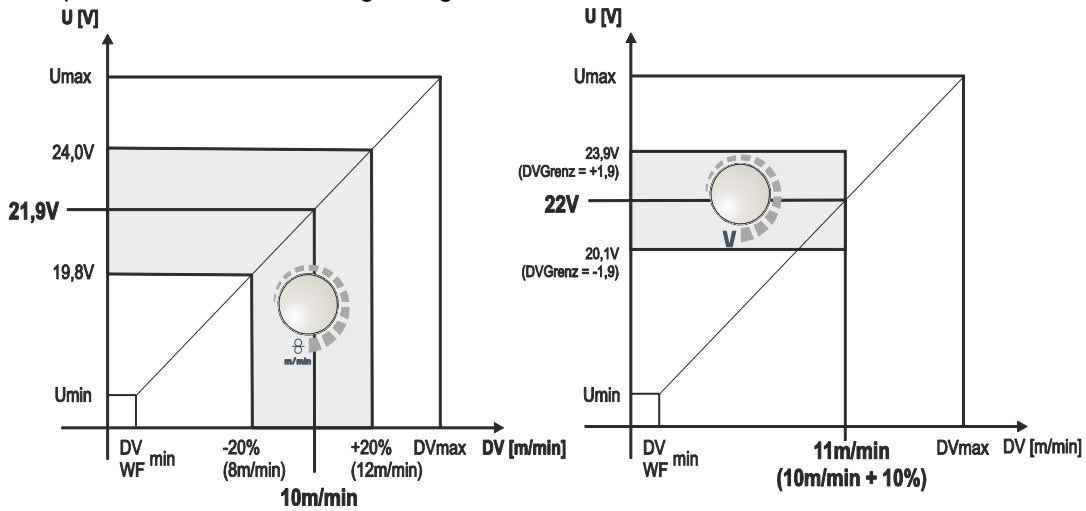

Figure 5-44

Example for the operating point in correction mode:

The wire speed in one program (1 to 15) is set on 10.0 m/min.

This corresponds to a welding voltage (U) of 21,9 V. When the key switch is set to "0" position, welding in this program can only be carried out with these values.

To allow the welder also to perform wire and voltage correction in program mode, the correction mode must be switched on and limit values for wire and voltage must be specified.

Setting of the correction limit value = WFlimit = 20% / Ulimit = 1.9 V

Now the wire speed can be corrected by 20% (8.0 up to 12.0 m/min) and the welding voltage by +/-1.9 V (3.8 V).

In the example the wire speed is set on 11.0 m/min. This corresponds to a welding voltage of 22 V

Now the welding voltage can be corrected by further 1.9 V (20.1 V and 23.9 V).

The values for voltage and wire-speed correction will be reset if the key switch is moved to the "1" setting.

Setting the correction range:

- Switch on the "Correction operation" special parameter (P7=1) and save the setting.
> see 5.18.1 chapter
- Key switch to position "1".
- Set correction range according to the following table:

Operating element	Action	Result	Display (examples)	
			Left	Right
		Press button until "PROG" LED comes on. Left: Wire feed speed Right: Program number		
		Press button and hold down for approx. 4 s Left: Current limit value of the wire feed speed correction Right: Current limit value of the voltage correction		
		Set limit value for the wire feed speed correction		
		Set limit value for voltage correction		
After approx. 5 s without further user intervention, the set values are adopted and the display switches back to the program display,				

- Key switch back to position "0"!

Switching programs with the standard torch trigger (P8)

Special latched (latched absolute program sequence)

- Cycle 1: absolute program 1 is run
- Cycle 2: absolute program 2 is run after completion of "tstart".
- Cycle 3: absolute program 3 is run until the "t3" time has elapsed. The program then switches automatically to absolute program 4.

Accessory components such as remote controls or special torches may not be connected!

Program switching at the wire feed unit control is disabled.

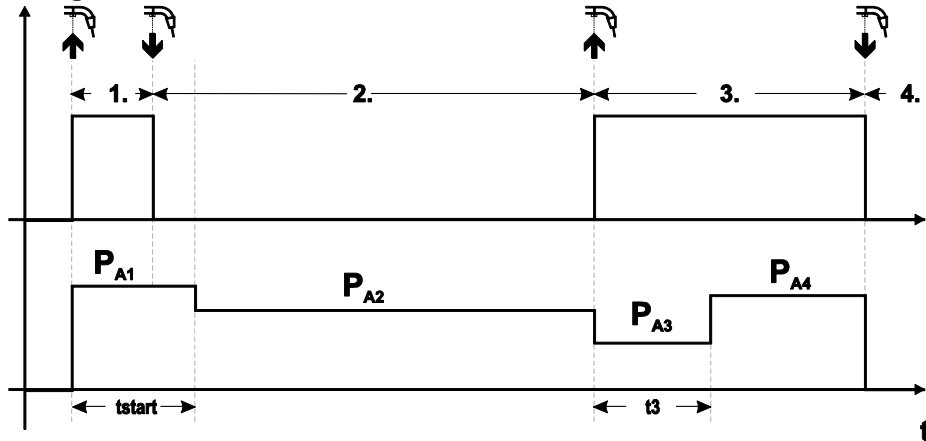

Figure 5-45

Specific latched special (n cycle)

In the n cycle program sequence, the unit starts in the 1st cycle with start program P_{start} from P_1

In the second cycle, the machine switches to absolute program 2, once the start time "tstart" has elapsed.

Tapping switches to other programs (P_{A1} to max. P_{A9}).

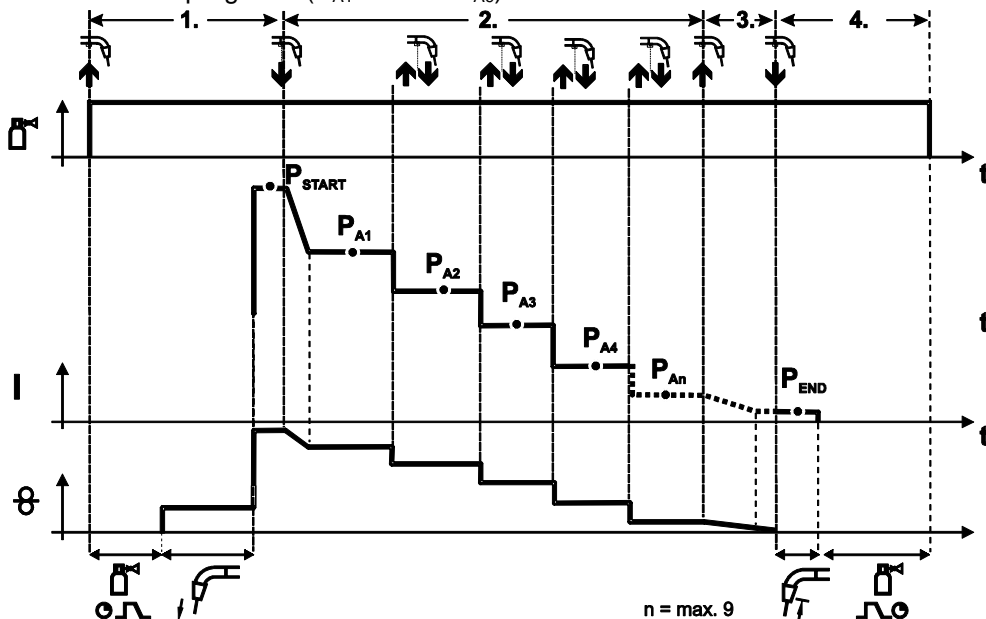

Figure 5-46

The number of programs (P_{AN}) corresponds to the cycle number specified under N cycle.

1st cycle

- Press and hold torch trigger.
- Shielding gas is expelled (gas pre-flows).
- Wire feed motor runs at "creep speed".
- Arc ignites after the wire electrode makes contact with the workpiece, welding current is flowing (start program P_{START} from P_{A1})

2nd cycle

- Release torch trigger.
- Slope to main program P_{A1} .

The slope to main program P_{A1} is given at the earliest after the set time t_{START} elapses and at the latest when the torch trigger is released. Tapping (pressing briefly and releasing within 0.3 sec) can switch to other programs. Programs P_{A1} to P_{A9} are possible.

3rd cycle

- Press and hold torch trigger.
- Slope to end program P_{END} from P_{AN} . The program can be stopped at any time by pressing the torch trigger longer than 0.3 sec. P_{END} from P_{AN} is then executed.

4th cycle

- Release torch trigger.
- WF motor stops.
- Arc is extinguished after the pre-selected wire burn-back time elapses.
- Gas post-flow time elapses.

Latched/special-latched tap start (P9)

In latched – tap start – operating mode it is possible to switch straight to the second step by tapping the torch trigger; it is not necessary for current to be flowing.

The welding can be halted by pressing the torch trigger for a second time.

"Single or dual operation" (P10) setting

 **If the system is fitted with two wire feeds, no further accessory components may be operated on the 7-pole connection socket (digital)!**

This relates to digital remote controls, robot interfaces, documentation interfaces, welding torches with digital control lead connection, etc.

No second wire feed may be connected in single operation (P10 = 0)!

- Remove connections to the second wire feed

In dual operation (P10 = 1 or 2), both wire feed units must be connected and configured differently on the controls for this operating mode!

- Configure one wire feed unit as the master (P10 = 1)
- Configure the other wire feed unit as a slave (P10 = 2)

Wire feed units with key switches (optional, > see 5.16 chapter) must be configured as masters (P10 = 1).

The wire feed configured as the master is active after the welding machine is switched on. There are no other functional differences between the wire feeds.

Latched special tapping time setting (P11)

The tapping time for changing over between the main program and reduced main program can be set in three levels.

0 = no tapping

1 = 320ms (factory setting)

2 = 640ms

JOB list switching (P12)

Value	Designation	Explanation
0	Task-oriented JOB list	The JOB numbers are sorted by welding wires and shielding gases. JOB numbers may be skipped during selection where relevant.
1	Actual JOB list	JOB numbers correspond to the actual memory cells. Each JOB can be selected; no memory cells are skipped during selection.
2	Actual JOB list, JOB changeover active	As for the actual JOB list. JOB changeover is also possible with accessory components, such as the PowerControl 2 torch.

Creating user-defined JOB lists

A consecutive memory range where accessories such as the POWERCONTROL 2 torch can be used to switch between JOBS will be created.

- Set special parameter P12 to "2".
- Set "Program or Up/Down function" changeover switch to "Up/Down" position.
- Select an existing JOB which is closest to the required result.
- Copy JOB to one or more target JOB numbers.

If any JOB parameters need to be changed, select the target JOBS in sequence and change the parameters individually.

- Set special parameter P13 to the lower limit and
- Set special parameter P14 to the upper limit of the target JOBS.
- Set "Program or Up/Down function" changeover switch to "Program" position.

JOBS can be changed over in the specified range using the accessory component.

Copying JOBS, "Copy to" function

The possible target range is between 129 - 169.

- First configure special parameter P12 to P12 = 2 or P12 = 1!

Operating element	Action	Result	Display
	1 x	JOB list selection	
		Source JOB selection	
-	-	Wait for approx. 3 s for the JOB to be applied	
	1 x	Keep the push-button pressed for approx. 5 s	
		Copy setting to function ("Copy to")	
		Source JOB number selection	
	1 x	Save The JOB is copied to the new target	

By repeating the last two steps the same source JOB can be copied to several target JOBS.

If the control detects user inactivity for more than 5 s, it switches to parameter display again and the copy operation is finished.

Lower and upper limits of the remote JOB changeover process (P13, P14)

The highest and lowest JOB numbers which can be selected using accessory components, such as the PowerControl 2 torch.

Avoids an accidental changeover into undesirable or undefined JOBs.

Hold function (P15)

Hold function active (P15 = 1)

- Mean values for the last main program parameters used for welding are displayed.

Hold function not active (P15 = 0)

- Setpoint values for the main program parameters are displayed.

Block JOB mode (P16)

The following accessory components support block JOB mode:

- Up/Down welding torch with one-digit 7-segment display (two keys)
Program 0 is always active in JOB 0 and program 1 in all other JOBs

In this operating mode, a total of 27 JOBs (welding tasks) divided into three blocks can be called up using accessory components.

The following settings must be made in order to be able to use block JOB mode:

- Switch the "Program or Up/Down function" changeover switch to "Program"
- Set the JOB list to actual JOB list (special parameter P12 = "1")
- Enable block JOB mode (special parameter P16 = "1")
- Change to block JOB mode by selecting one of the special JOBs 129, 130 or 131.

Simultaneous operation with interfaces such as RINT X12, BUSINT X11, DVINT X11 or digital accessory components such as is the R40 remote control is not possible!

Allocation of JOB numbers to the display on the accessory components

JOB no.	Display/selection on the accessory component									
	0	1	2	3	4	5	6	7	8	9
Special JOB 1	129	141	142	143	144	145	146	147	148	149
Special JOB 2	130	151	152	153	154	155	156	157	158	159
Special JOB 3	131	161	162	163	164	165	166	167	168	169

JOB 0:

This JOB allows you to set the welding parameters manually.

Selection of JOB 0 can be prevented via the key switch or with the "block program 0" parameter (P2).

Key switch position 0, or special parameter P2 = 0: JOB 0 is blocked.

Key switch position 1, or special parameter P2 = 1: JOB 0 can be selected.

JOBS 1-9:

Nine JOBs can be called up in each special JOB (see table).

Nominal values for wire speed, arc correction, dynamics etc must be defined in advance in these JOBs. This can be done easily with the PC300.NET software.

If the software is not available, user-defined JOB lists can be created in the special JOB areas with the "Copy to" function. (See explanations about this in the "Switching JOB lists (P12)" chapter)

Selecting programs with the standard torch trigger (P17)

Allows you to select a program or switch a program before starting welding.

You switch to the next program by tapping the torch trigger. Once the last enabled program is reached, you start again at the beginning.

- Program 0 is the first enabled program, provided that it is not blocked. (see also special parameter P2).
- The last enabled program is P15.
 - If the programs are not limited by special parameter P4 (see special parameter P4).
 - Or if the programs are limited for the selected JOB by the n cycle setting (see parameter P8).
- Welding starts when the torch trigger is held for longer than 0.64 s.

You can select programs with the standard torch trigger in all operating modes (non-latched, special non-latched, latched and special latched).

Switching the operating mode and welding type using the wire feed control (P18)

Selecting the operating mode (non-latched, latched, etc.) and welding type (MIG/MAG standard welding/pulse arc welding) at the wire feed unit control or the welding machine control.

- P18 = 0
 - Program 0: To select the operating mode and welding type at the wire feed unit.
 - Program 1-15: To select the operating mode and welding type at the welding machine.
- P18 = 1
 - Program 0-15: To select the operating mode and welding type at the wire feed unit.

Mean value display for superPuls (P19)

Function active (P19 = 1)

- For superPuls, the performance **mean value** from program A (P_A) and program B (P_B) is shown on the display (ex factory).

Function inactive (P19 = 0)

- Only the performance of program A is displayed for superPuls.



If the function is enabled and only "000" is shown on the machine display, this is a rare case of an incompatible system set-up. Solution: Disable special parameter P19.

Predefined execution of the pulsed arc welding process in the PA program (P20)



For machine versions with pulsed arc welding procedures only.

Function active (P20 = 1)

- If the superPuls and welding process switching functions are available and activated, the pulse arc welding process is always executed in the main program PA (ex factory).

Function inactive (P20 = 0)

- Predefined execution of the pulse arc welding process in the PA program is disabled.

Predefined absolute value for relative programs (P21)

Start program (P_{START}), down-slope program (P_B) and end program (P_{END}) can be set relative to the main program (P_A) or in an absolute manner, as desired.

Function active (P21 = 1)

- Absolute parameter setting

Function inactive (P21 = 0)

- Relative parameter setting (ex factory)

Electronic gas flow control, type (P22)

Active only in machines with integrated gas flow control (option ex works).

Adjustment may only be carried out by authorised service personnel (basic setting = 1).

Program settings for relative programs (P23)

The start, down-slope and end program relative programs can be set individually or combined for the P0-P15 operating points. When choosing the combined setting, in contrast to the individual setting, the parameter values are saved in the JOB. With the individual setting, the parameter values are identical for all JOBs (except for special JOBs SP1, SP2 and SP3).

Correction or nominal voltage display (P24)

When setting the arc correction using the right-hand rotary knob the display will either show the correction voltage ± 9.9 V (ex works) or the absolute nominal voltage.

5.18 Machine configuration menu

5.18.1 Selecting, changing and saving parameters



ENTER (Enter the menu)

- *Switch off the machine at the main switch.*
- *Press and hold the "welding parameters" or "choke effect" (drive 4X LP) push-button and switch the machine on again at the same time.*

NAVIGATION (Navigate the menu)

- *Select parameters by turning the "welding parameter setting" rotary knob.*
- *Set or change parameters by turning the "arc length correction/select welding program" rotary knob.*

EXIT (Exit the menu)

- *Press the "parameter selection right" push-button (switch machine off and on again).*

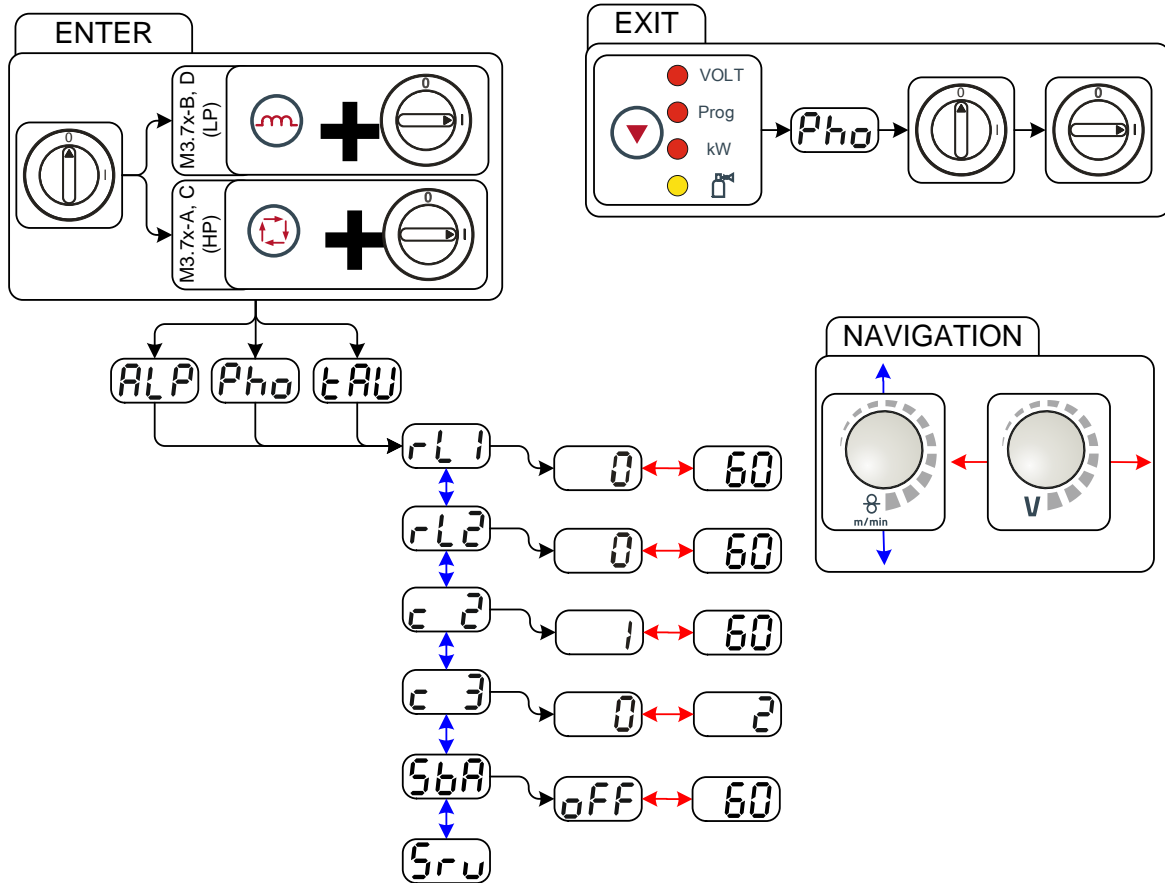

Figure 5-47

Display	Setting/selection
rL1	Lead resistance 1 Lead resistance for the first welding circuit 0 mΩ–60 mΩ (8 mΩ ex works).
rL2	Lead resistance 2 Lead resistance for the second welding circuit 0 mΩ–60 mΩ (8 mΩ ex works).
c2	Only qualified service personnel may change the parameters!
c3	Only qualified service personnel may change the parameters!
S6A	Time-based power-saving mode <ul style="list-style-type: none"> • 5 min.–60 min. = Time to activation of power-saving mode in case of inactivity. • off = inactivated
Sru	Service menu Modifications to the service menu may only be carried out by authorised maintenance staff!

5.18.2 Aligning the cable resistance

The resistance value of cables can either be set directly or it can be aligned using the power source. The factory setting of the power sources is 8 mΩ. This value corresponds to a 5 m earth cable, a 1.5 m intermediate hose package and a 3 m water-cooled welding torch. With other hose package lengths, it is necessary to carry out a +/- voltage correction to optimise welding properties. The voltage correction value can be set close to zero by means of realigning the cable resistance. It is recommended to align the electric cable resistance after replacing accessories such as torches or intermediate hose packages.

In case a second wire feeder is used the (rL2) parameter has to be aligned. For all other configurations it is sufficient to align the (rL1) parameter.

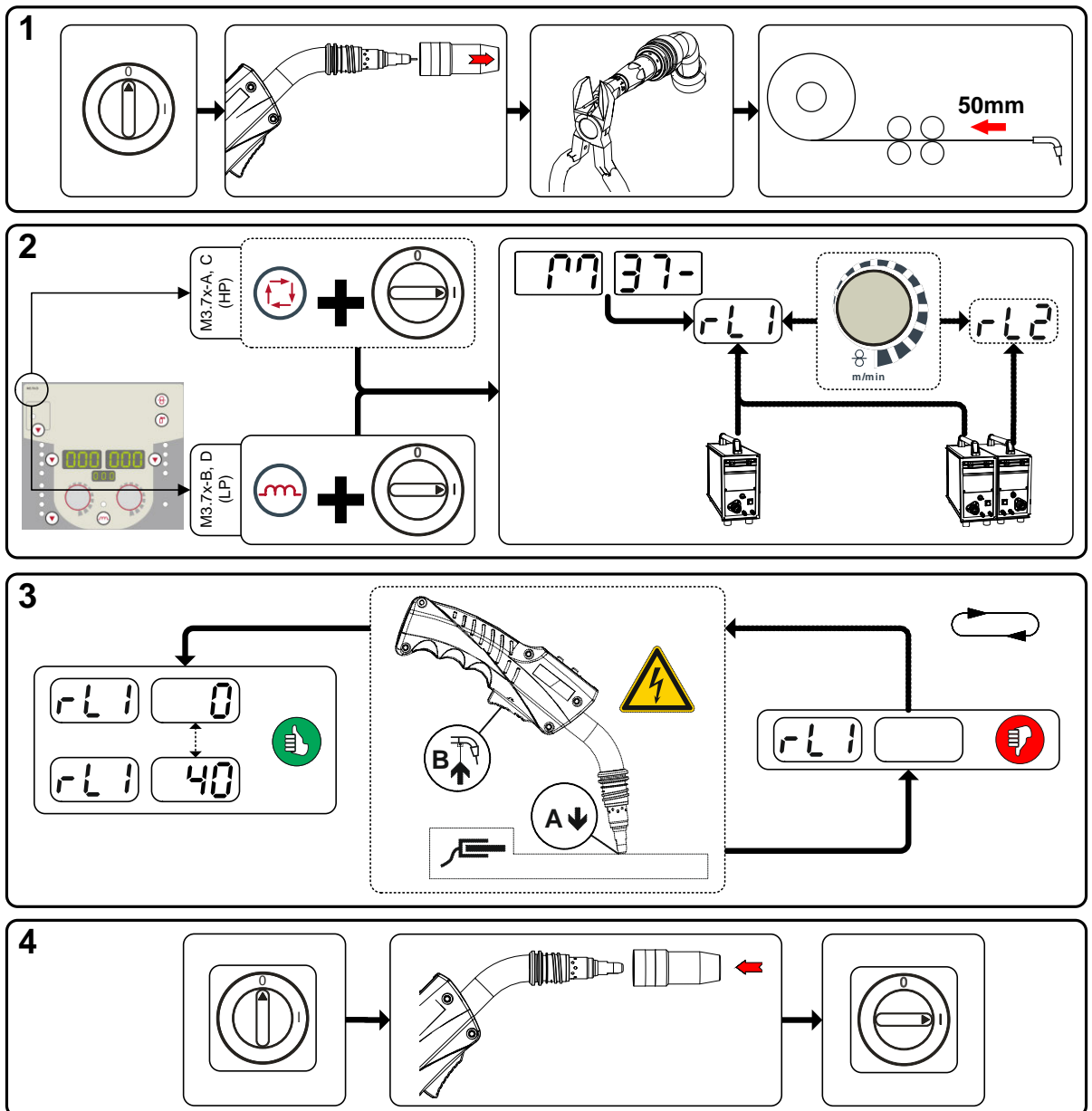

Figure 5-48

1 Preparation

- Switch off the welding machine.
- Unscrew the gas nozzle from the welding torch.
- Trim the welding wire, so that it is flush with the contact tip.
- Retract the welding wire a little (approx. 50 mm) on the wire feeder. There should now be no more welding wire in the contact tip.

2 Configuration

- Press the "welding parameter or choke effect" push-button while simultaneously switching on the welding machine. Release push-button.
 - "Welding parameter" push-button on the M3.7x-A and M3.7x-C control.
 - "Choke effect" push-button on the M3.7x-B and M3.7x-D control.
- The required parameter can now be selected using the 'Welding parameter setting' rotary knob. Parameter rL1 must be aligned for all machine combinations. In case of welding systems with a second power circuit – if two wire feeders are to be operated from a single power source, for example – a second alignment with parameter rL2 must be performed.

3 Alignment/measurement

- Applying slight pressure, put the welding torch in place with the contact tip on a clean, purged location on the workpiece and then press the torch trigger for approx. 2 seconds. A short-circuit current will flow briefly, which is used to determine and display the cable resistance. The value can be between 0 mΩ and 40 mΩ. The new value is immediately saved without requiring further confirmation. If no value is shown on the right-hand display, then measurement failed. The measurement must be repeated.

4 Restoring welding standby mode

- Switch off the welding machine.
- Screw the gas nozzle onto the welding torch.
- Switch on the welding machine
- Insert the welding wire.

5.18.3 Power-saving mode (Standby)

You can activate the power-saving mode by either pressing the push-button > see 5.18 chapter for a prolonged time or by setting a parameter in the machine configuration menu (time-controlled power-saving mode) > see 5.18 chapter.

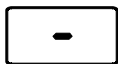

When power-saving mode is activated, the machine displays show the horizontal digit in the centre of the display only.

Pressing any operating element (e.g. tapping the torch trigger) deactivates power-saving mode and the machine is ready for welding again.

6 Maintenance, care and disposal

DANGER



Improper maintenance and testing

The equipment may only be cleaned, repaired or tested by specialist, skilled persons! A skilled person is one who, due to training, knowledge and experience, is able to recognise the dangers that can occur during testing of this equipment as well as possible subsequent damage and who is able to implement the required safety procedures.

- Complete all tests given in the chapter below!
- Only put the equipment back into operation following a successful test.



Risk of injury from electric shock!

Cleaning machines that are not disconnected from the mains can lead to serious injuries!

- Disconnect the machine completely from the mains.
- Remove the mains plug!
- Wait for 4 minutes until the capacitors have discharged!

Repair and maintenance work may only be performed by qualified authorised personnel; otherwise the right to claim under warranty is void. In all service matters, always consult the dealer who supplied the machine. Return deliveries of defective equipment subject to warranty may only be made through your dealer. When replacing parts, use only original spare parts. When ordering spare parts, please quote the machine type, serial number and item number of the machine, as well as the type designation and item number of the spare part.

6.1 General

When used in the specified environmental conditions and under normal operating conditions, this machine is largely maintenance-free and requires a minimum of care.

There are some points, which should be observed, to guarantee fault-free operation of your welding machine. Among these are regular cleaning and checking as described below, depending on the pollution level of the environment and the length of time the unit is in use.

6.2 Maintenance work, intervals

6.2.1 Daily maintenance tasks

- Check that all connections and wearing parts are hand-tight and tighten if necessary.
- Check that all screw and plug connections and replaceable parts are secured correctly, tighten if necessary.
- Remove any spatter.
- Clean the wire feed rollers on a regular basis (depending on the degree of soiling).

6.2.1.1 Visual inspection

- Check hose package and power connections for exterior damage and replace or have repaired by specialist staff as necessary!
- Mains supply lead and its strain relief
- Gas tubes and their switching equipment (solenoid valve)
- Other, general condition

6.2.1.2 Functional test

- Check correct mounting of the wire spool.
- Welding current cables (check that they are fitted correctly and secured)
- Gas cylinder securing elements
- Operating, message, safety and adjustment devices (Functional test)

6.2.2 Monthly maintenance tasks

6.2.2.1 Visual inspection

- Casing damage (front, rear and side walls)
- Wheels and their securing elements
- Transport elements (strap, lifting lugs, handle)
- Check coolant tubes and their connections for impurities

6.2.2.2 Functional test

- Selector switches, command devices, emergency stop devices, voltage reducing devices, message and control lamps
- Check that the wire guide elements (inlet nipple, wire guide tube) are fitted securely.

6.2.3 Annual test (inspection and testing during operation)



The welding machine may only be tested by competent, capable persons! A capable person is one who, because of his training, knowledge and experience, is able to recognise the dangers that can occur while testing welding power sources as well as possible subsequent damage and who is able to implement the required safety procedures.



For more information refer to the "Warranty registration" brochure supplied and our information regarding warranty, maintenance and testing at www.ewm-group.com!

A periodic test according to IEC 60974-4 "Periodic inspection and test" has to be carried out. In addition to the regulations on testing given here, the relevant local laws and regulations must also be observed.

6.3 Disposing of equipment



Proper disposal!

The machine contains valuable raw materials, which should be recycled, and electronic components, which must be disposed of.

- **Do not dispose of in household waste!**
- **Observe the local regulations regarding disposal!**



6.3.1 Manufacturer's declaration to the end user

- According to European provisions (guideline 2002/96/EG of the European Parliament and the Council of January, 27th 2003), used electric and electronic equipment may no longer be placed in unsorted municipal waste. It must be collected separately. The symbol depicting a waste container on wheels indicates that the equipment must be collected separately. This machine is to be placed for disposal or recycling in the waste separation systems provided for this purpose.
- According to German law (law governing the distribution, taking back and environmentally correct disposal of electric and electronic equipment (ElektroG) from 16.03.2005), used machines are to be placed in a collection system separate from unsorted municipal waste. The public waste management utilities (communities) have created collection points at which used equipment from private households can be disposed of free of charge.
- Information about giving back used equipment or about collections can be obtained from the respective municipal administration office.
- EWM participates in an approved waste disposal and recycling system and is registered in the Used Electrical Equipment Register (EAR) under number WEEE DE 57686922.
- In addition to this, returns are also possible throughout Europe via EWM sales partners.

6.4 Meeting the requirements of RoHS

We, EWM AG Mündersbach, hereby confirm that all products supplied by us which are affected by the RoHS Directive, meet the requirements of the RoHS (Directive 2011/65/EU).

7 Rectifying faults

All products are subject to rigorous production checks and final checks. If, despite this, something fails to work at any time, please check the product using the following flowchart. If none of the fault rectification procedures described leads to the correct functioning of the product, please inform your authorised dealer.

7.1 Checklist for rectifying faults



The correct machine equipment for the material and process gas in use is a fundamental requirement for perfect operation!

Legend	Symbol	Description
	↘	Fault/Cause
	✘	Remedy

Wire feed problems

- ↘ Contact tip blocked
 - ✘ Clean, spray with anti-spatter spray and replace if necessary
- ↘ Setting the spool brake > see 5.10.2.5 chapter
 - ✘ Check settings and correct if necessary
- ↘ Setting pressure units > see 5.10.2.4 chapter
 - ✘ Check settings and correct if necessary
- ↘ Worn wire rolls
 - ✘ Check and replace if necessary
- ↘ Wire feed motor without supply voltage (automatic cutout triggered by overloading)
 - ✘ Reset triggered fuse (rear of the power source) by pressing the key button
- ↘ Kinked hose packages
 - ✘ Extend and lay out the torch hose package
- ↘ Wire guide core or spiral is dirty or worn
 - ✘ Clean core or spiral; replace kinked or worn cores

Functional errors

- ↘ All machine control signal lights are illuminated after switching on
- ↘ No machine control signal light is illuminated after switching on
- ↘ No welding power
 - ✘ Phase failure > check mains connection (fuses)
- ↘ Various parameters cannot be set
 - ✘ Entry level is blocked, disable access lock > see 5.16 chapter
- ↘ Connection problems
 - ✘ Make control lead connections and check that they are fitted correctly.
- ↘ Loose welding current connections
 - ✘ Tighten power connections on the torch and/or on the workpiece
 - ✘ Tighten contact tip correctly

7.2 Error messages (power source)

 **A welding machine error is indicated by an error code being displayed (see table) on the display on the machine control.**

In the event of a machine error, the power unit is shut down.

 **The display of possible error numbers depends on the machine version (interfaces/functions).**



- Document machine errors and inform service staff as necessary.
- If multiple errors occur, these are displayed in succession.

Error	Category			Possible cause	Remedy
	a)	b)	c)		
Error 1 (Ov.Vol)	-	-	x	Mains overvoltage	Check the mains voltages and compare with the connection voltages of the welding machine
Error 2 (Un.Vol)	-	-	x	Mains undervoltage	
Error 3 (Temp)	x	-	-	Welding machine excess temperature	Allow the machine to cool down (mains switch to "1")
Error 4 (Water)	x	x	-	Low coolant level	Top off the coolant Leak in the coolant circuit > rectify the leak and top off the coolant Coolant pump is not working > check excess current trigger on air cooling unit
Error 5 (Wi.Spe)	x	-	-	Wire feeder/speedometer error	Check the wire feeder speedometer is not issuing a signal, M3.51 defective > inform Service
Error 6 (gas)	x	-	-	Shielding gas error	Check shielding gas supply (for machines with shielding gas monitoring)
Error 7 (Se.Vol)	-	-	x	Secondary excess voltage	Inverter error > inform Service
Error 8 (no PE)	-	-	x	Earth fault between welding wire and earth line	Separate the connection between the welding wire and casing or an earthed object
Error 9 (fast stop)	x	-	-	Fast cut-out triggered by BUSINT X11 or RINT X12	Rectify error on robot
Error 10 (no arc)	-	x	-	Arc break triggered by BUSINT X11 or RINT X12	Check wire feeding
Error 11 (no ign)	-	x	-	Ignition fault after 5 s triggered by BUSINT X11 or RINT X12	Check wire feeding
Error 14 (no DV)	-	x	-	Wire feeder not detected. Control cable not connected.	Check cable connection
				Incorrect ID numbers assigned during operation with multiple wire feeders.	Check assignment of ID numbers
Error 15 (DV2?)	-	x	-	Wire feeder 2 not detected. Control cable not connected.	Check cable connection
Error 16 (VRD)	-	-	x	VRD (open circuit voltage reduction error)	Inform Service
Error 17 (WF. Ov.)	-	x	x	Wire feed mechanism overcurrent detection	Check the wire feeding
Error 18 (WF. Sl.)	-	x	x	No speedometer signal from second wire feeder (slave drive)	Check the connection and particularly the speedometer of the second wire feeder (slave drive).

Error	Category			Possible cause	Remedy
	a)	b)	c)		
Error 56 (no Pha)	-	-	x	Mains phase failure	Check mains voltages
Error 59 (Unit?)	-	-	x	Machine incompatible	Check machine used

Legend for categories (error reset)

- a) The error message will disappear once the error has been rectified.
 b) The error message can be reset by pressing a key button:

Welding machine control	Key button
RC1 / RC2	
Expert	
CarExpert / Progress (M3.11)	
alpha Q / Concept / Basic / Basic S / Synergic / Synergic S / Progress (M3.71) / Picomig 305	not possible

- c) The error message can only be reset by switching the machine off and on again.
 The shielding gas error (Err 6) can be reset by pressing the "Welding parameters" key button.

7.3 Resetting JOBS (welding tasks) to the factory settings

All customised welding parameters that are stored will be replaced by the factory settings.

7.3.1 Resetting a single JOB

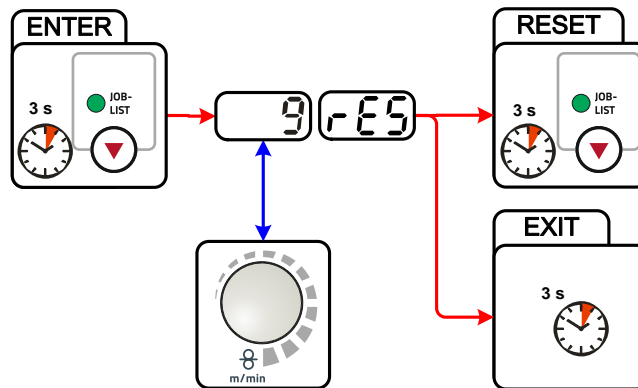

Figure 7-1

Display	Setting/selection
	RESET to factory settings The RESET will be done after pressing the button. The menu will be ended when no changes are done after 3 sec.
	JOB-number (example) The shown JOB will be set to ex works.

7.3.2 Resetting all JOBs

JOBS 1–128 and 170–256 will be reset.
Custom JOBS 129–169 are maintained.

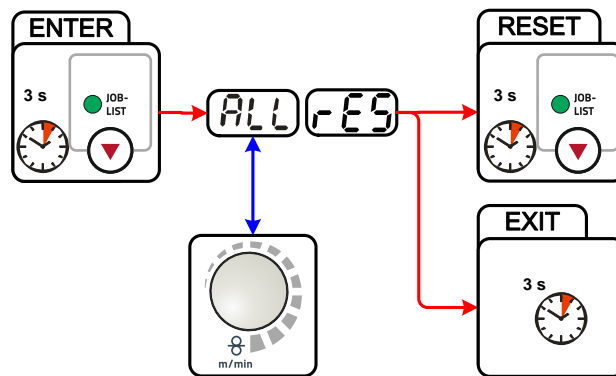

Figure 7-2

Display	Setting/selection
	RESET to factory settings The RESET will be done after pressing the button. The menu will be ended when no changes are done after 3 sec.

8 Technical data

8.1 Taurus 355 Synergic S

 **Performance specifications and guarantee only in connection with original spare and replacement parts!**

	MIG/MAG	MMA	TIG
Setting range Welding current	5 A-350 A		
Setting range Welding voltage	14,3 V - 31,5 V	20,2 V - 34,0 V	10,2 V - 24,0 V
Duty cycle at 25 °C ambient temperature			
45% DC	350 A		
60% DC	320 A		
100% DC	290 A		
Duty cycle at 40 °C ambient temperature			
40% DC	350 A		
60% DC	300 A		
100% DC	270 A		
Wire spool diameter	Standardized wire spools up to 300 mm		
Load alternation	10 min. (60% DC Δ 6 min. welding, 4 min. pause)		
Open circuit voltage	79 V		
Mains voltage (tolerances)	3 x 400 V (-25% to +20%)		
Frequency	50/60 Hz		
Mains fuse (safety fuse, slow-blow)	3 x 16 A		
Mains connection lead	H07RN-F4G2.5		
Maximum connected load	13.9 kVA	15.0 kVA	10.6 kVA
Recommended generator rating	20,3 kVA		
Cos ϕ / Efficiency	0.99% / 88%		
Insulation class/protection classification	H/IP 23		
Ambient temperature	-25 °C to +40 °C		
Machine cooling	Fan		
Workpiece lead	50 mm ²		
Dimensions L/W/H [mm]	636 x 298 x 482		
Weight	36 kg		
Wire feed speed	0.5 m/min to 25 m/min		
Factory-fit roller equipment	1.0 mm + 1.2 mm (for steel wire)		
Drive	4-roller (37 mm)		
EMC class	A		
Constructed to standards	IEC 60974-1, -5, -10 S / CE		

9 Accessories

 Performance-dependent accessories like torches, workpiece leads, electrode holders or intermediate hose packages are available from your authorised dealer.

9.1 General accessories

Type	Designation	Item no.
Trolley 55-5	Transport cart, assembled	090-008632-00000
cool50 U40	Cooling module	090-008598-00502
voltConverter 230/400	Voltage converter	090-008800-00502
TYP 1	Frost protection tester	094-014499-00000
KF 23E-10	Coolant (-10 °C), 9.3 l	094-000530-00000
KF 23E-200	Coolant (-10 °C), 200 litres	094-000530-00001
KF 37E-10	Coolant (-20 °C), 9.3 l	094-006256-00000
KF 37E-200	Coolant (-20 °C), 200 l	094-006256-00001
AK300	Wire spool adapter K300	094-001803-00001
CA D200	Centering adapter for 5-kg spools	094-011803-00000
DM 842 Ar/CO2 230bar 30l D	Pressure regulator with manometer	394-002910-00030
ADAPTER EZA --> DINSE-ZA	Adapter for welding torches with Dinse connector to Euro central connector, on the machine	094-016765-00000
GH 2X1/4" 2M	Gas hose	094-000010-00001
5POLE/CEE/32A/M	Machine plug	094-000207-00000

9.2 Remote control/connecting and extension cable

9.2.1 7-pole connection

Type	Designation	Item no.
R40 7POL	Remote control, 10 programs	090-008088-00000
R50 7POL	Remote control, all welding machine functions can be set directly at the workplace	090-008776-00000
FRV 7POL 0.5 m	Extension/connecting cable	092-000201-00004
FRV 7POL 1 m	Extension/connecting cable	092-000201-00002
FRV 7POL 5 m	Extension/connecting cable	092-000201-00003
FRV 7POL 10 m	Extension/connecting cable	092-000201-00000
FRV 7POL 20 m	Extension/connecting cable	092-000201-00001
FRV 7POL 25M	Extension/connecting cable	092-000201-00007

9.2.2 19-pole connection

Type	Designation	Item no.
R10 19POL	Remote control	090-008087-00000
RG10 19POL 5M	Remote control to set the wire speed and welding voltage correction	090-008108-00000
R20 19POL	Program changeover remote control	090-008263-00000
PHOENIX RF11 19POL 5M	Foot-operated remote control for PHOENIX EXPERT	094-008196-00000
RA5 19POL 5M	Remote control e.g. connection cable	092-001470-00005
RA10 19POL 10M	Remote control e.g. connection cable	092-001470-00010
RA20 19POL 20M	Remote control e.g. connection cable	092-001470-00020
RV5M19 19POLE 5M	Extension cable	092-000857-00000
RV5M19 19POL 10M	Extension cable	092-000857-00010
RV5M19 19POL 15M	Extension cable	092-000857-00015
RV5M19 19POL 20M	Extension cable	092-000857-00020

9.3 Options

Type	Designation	Item no.
ON D XX5 BARREL	Wire guide Rolliner for drum feed	092-007929-00000
ON Filter XX5	Dirt filter	092-002662-00000
ON CS K	Crane suspension for Picomig 180 / 185 D3 / 305 D3, Phoenix and Taurus 355 compact, drive 4	092-002549-00000

9.4 Computer communication

Type	Designation	Item no.
PC300.Net	PC300.Net welding parameter software kit incl. cable and SECINT X10 USB interface	090-008777-00000
ON WLG-EX	Wi-Fi gateway in external casing	090-008790-00502
ON LG-EX	LAN gateway in external casing	090-008789-00502
FRV 7POL 5 m	Extension/connecting cable	092-000201-00003
FRV 7POL 10 m	Extension/connecting cable	092-000201-00000
FRV 7POL 20 m	Extension/connecting cable	092-000201-00001
QDOC9000 V2.0	Set consisting of interface, documentation software, connection lead	090-008713-00000

10 Replaceable parts



The manufacturer's warranty becomes void if non-genuine parts are used!

- **Only use system components and options (power sources, welding torches, electrode holders, remote controls, spare parts and replacement parts, etc.) from our range of products!**
- **Only insert and lock accessory components into the relevant connection socket when the machine is switched off.**

10.1 Wire feed rollers

10.1.1 Wire feed rollers for steel wire

Type	Designation	Item no.
FE 4R 0.6 MM/0.023 INCH LIGHT PINK	Drive roll set, 37 mm, 4 rolls, V-groove for steel, stainless steel and brazing	092-002770-00006
FE 4R 0.8 MM/0.03 INCH WHITE	Drive roll set, 37 mm, 4 rolls, V-groove for steel, stainless steel and brazing	092-002770-00008
FE 4R 1,0 MM/0.04 INCH BLUE	Drive roll set, 37 mm, 4 rolls, V-groove for steel, stainless steel and brazing	092-002770-00010
FE 4R 1.2 MM/0.045 INCH RED	Drive roll set, 37 mm, 4 rolls, V-groove for steel, stainless steel and brazing	092-002770-00012
FE 4R 1.4 MM/0.052 INCH GREEN	Drive roll set, 37 mm, 4 rolls, V-groove for steel, stainless steel and brazing	092-002770-00014
FE 4R 1.6 MM/0.06 INCH BLACK	Drive roll set, 37 mm, 4 rolls, V-groove for steel, stainless steel and brazing	092-002770-00016
FE 4R 2.0 MM/0.08 INCH GREY	Drive roll set, 37 mm, 4 rolls, V-groove for steel, stainless steel and brazing	092-002770-00020
FE 4R 2.4 MM/0.095 INCH BROWN	Drive roll set, 37 mm, 4 rolls, V-groove for steel, stainless steel and brazing	092-002770-00024
FE 4R 2.8 MM/0.11 INCH LIGHT GREEN	Drive roll set, 37 mm, 4 rolls, V-groove for steel, stainless steel and brazing	092-002770-00028
FE 4R 3.2 MM/0.12 INCH VIOLET	Drive roll set, 37 mm, 4 rolls, V-groove for steel, stainless steel and brazing	092-002770-00032

10.1.2 Wire feed rollers for aluminium wire

Type	Designation	Item no.
AL 4R 0.8 MM/0.03 INCH WHITE	Drive roll set, 37 mm, for aluminium	092-002771-00008
AL 4R 1.0 MM/0.04 INCH BLUE	Drive roll set, 37 mm, for aluminium	092-002771-00010
AL 4R 1.2 MM/0.045 INCH RED	Drive roll set, 37 mm, for aluminium	092-002771-00012
AL 4R 1.6 MM/0.06 INCH BLACK	Drive roll set, 37 mm, for aluminium	092-002771-00016
AL 4R 2.0 MM/0.08 INCH GREY/YELLOW	Drive roll set, 37 mm, for aluminium	092-002771-00020
AL 4R 2.4 MM/0.095 INCH BROWN/YELLOW	Drive roll set, 37 mm, for aluminium	092-002771-00024
AL 4R 2.8 MM/0.110 INCH LIGHT GREEN/YELLOW	Drive roll set, 37 mm, for aluminium	092-002771-00028
AL 4R 3.2 MM/0.125 INCH VIOLET/YELLOW	Drive roll set, 37 mm, for aluminium	092-002771-00032

10.1.3 Wire feed rollers for cored wire

Type	Designation	Item no.
FUEL 4R 0.8 MM/0.03 INCH WHITE/ORANGE	Drive roll set, 37 mm, 4 rolls, V-groove/knurled for flux cored wire	092-002848-00008
FUEL 4R 1.0 MM/0.04 INCH BLUE/ORANGE	Drive roll set, 37 mm, 4 rolls, V-groove/knurled for flux cored wire	092-002848-00010
FUEL 4R 1.2 MM/0.045 INCH RED/ORANGE	Drive roll set, 37 mm, 4 rolls, V-groove/knurled for flux cored wire	092-002848-00012
FUEL 4R 1.4 MM/0.052 INCH GREEN/ORANGE	Drive roll set, 37 mm, 4 rolls, V-groove/knurled for flux cored wire	092-002848-00014
FUEL 4R 1.6 MM/0.06 INCH BLACK/ORANGE	Drive roll set, 37 mm, 4 rolls, V-groove/knurled for flux cored wire	092-002848-00016
FUEL 4R 2.0 MM/0.08 INCH GREY/ORANGE	Drive roll set, 37 mm, 4 rolls, V-groove/knurled for flux cored wire	092-002848-00020
FUEL 4R 2.4 MM/0.095 INCH BROWN/ORANGE	Drive roll set, 37 mm, 4 rolls, V-groove/knurled for flux cored wire	092-002848-00024

10.1.4 Wire guide

Type	Designation	Item no.
SET DRAHTFUERUNG	Wire guide set	092-002774-00000
ON WF 2,0-3,2MM EFEED	Retrofitting option, wire guide for 2.0–3.2 mm wires, eFeed drive	092-019404-00000
SET IG 4x4 1.6mm BL	Inlet guide set	092-002780-00000
GUIDE TUBE L105	Guide tube	094-006051-00000
CAPTUB L108 D1,6	Capillary tube	094-006634-00000
CAPTUB L105 D2,0/2,4	Capillary tube	094-021470-00000

11 Appendix A

11.1 JOB-List

Massivdraht				Solidwire				forceArc®				forceArc puls®			
Material	Gas	Inch ∅ mm	.030	.040	.045	.060	Material	Gas	Inch ∅ mm	.030	.040	.045	.060		
			0,8	1,0	1,2	1,6				0,8	1,0	1,2	1,6		
Job-Nr.							Job-Nr.								
SG2/3 G3/4 Si1	CO ₂ -100 / C1		1	3	4	5	SG2/3 G3/4 Si1	Ar-90/CO ₂ -10 M20		190	254	255	256		
	Ar-82/CO ₂ -18 M21		6	8	9	10		Ar-82/CO ₂ -18 M21		189	179	180	181		
	Ar-90/CO ₂ -10 M20		11	13	14	15		Ar-97,5/CO ₂ -2,5 M12			251	252	253		
CrNi	Ar-97,5/ CO ₂ -2,5/ M12	318 / 1.4576	26	27	28	29	CrNi	Ar-100 / I1					247	248	
		307 / 1.4370	30	31	32	33									
		308 / 1.4316	34	35	36	37									
		316 / 1.4490	38	39	40	41									
		Duplex 2209 / 1.4462	42	43	44	45									
NiCr	Ar-He-CO ₂	625	46	47	48	49	NiCr	Ar-100 / I1						249	250
			271	272											
	Ar-He-CO ₂ Ar-He-H ₂ -CO ₂		275	276											
CuSi	Ar-100 / I1		98	99	100	101									
CuAl	Ar-100 / I1		106	107	108	109									
CuSi Löten / Brazing	Ar-100 / I1		114	115	116	117	CuSi Löten / Brazing	Ar-100 / I1		114	115	116	117		
	Ar97,5/CO ₂ -2,5 M12		110	111	112	113		Ar97,5/CO ₂ -2,5 M12		110	111	112	113		
CuAl Löten / Brazing	Ar-100 / I1		122	123	124	125	CuAl Löten / Brazing	Ar-100 / I1		122	123	124	125		
	Ar97,5/CO ₂ -2,5 M12		118	119	120	121		Ar97,5/CO ₂ -2,5 M12		118	119	120	121		
AlMg	Ar-100 / I1		74	75	76	77	AlMg	Ar-100 / I1		74	75	76	77		
	Ar-70/He-30 / I3		78	79	80	81		Ar-70/He-30 / I3		78	79	80	81		
AlSi	Ar-100 / I1		82	83	84	85	AlSi	Ar-100 / I1		82	83	84	85		
	Ar-70/He-30 / I3		86	87	88	89		Ar-70/He-30 / I3		86	87	88	89		
Al99	Ar-100 / I1		90	91	92	93	Al99	Ar-100 / I1		90	91	92	93		
	Ar-70/He-30 / I3		94	95	96	97		Ar-70/He-30 / I3		94	95	96	97		

rootArc®				rootArc puls®									
Material	Gas	Inch ∅ mm	.030	.040	.045	.060	Material	Gas	Inch ∅ mm	.030	.040	.045	.060
			0,8	1,0	1,2	1,6				0,8	1,0	1,2	1,6
Job-Nr.							Job-Nr.						
SG2/3 G3/4 Si1	CO ₂ -100 / C1			204	205		SG2/3 G3/4 Si1	Ar-82/CO ₂ -18 M21		206	207		
	Ar-82/CO ₂ -18 M21			206	207								

additional	
SP1	129
SP2	130
SP3	131
GMAW non synergic <8m / min	187
GMAW non synergic >8m / min	188
Fugen / gouging	126
WIG / TIG	127
E-Hand / MMA	128

Fülldraht				Flux-Cored									
Material	Gas	Inch ∅ mm	.030	.040	.045	.060	Material	Gas	Inch ∅ mm	.030	.040	.045	.060
			0,8	1,0	1,2	1,6				0,8	1,0	1,2	1,6
Job-Nr.							Job-Nr.						
G3Si1 / G4Si1 Metal	Ar-82/CO ₂ -21 M21		235	237	238	239	G3Si1 / G4Si1 Metal	Ar-82/CO ₂ -21 M21		235	237	238	239
G3Si1 / G4Si1 Rutil / Basic	Ar-82/CO ₂ -21 M21		240	242	243	244	G3Si1 / G4Si1 Rutil / Basic	Ar-82/CO ₂ -21 M21		240	242	243	244
	CO ₂ -100 / C1				260	261		CO ₂ -100 / C1				260	261
CrNi Metal	Ar-97,5/CO ₂ -2,5 M12				229	230	CrNi Metal	Ar-97,5/CO ₂ -2,5 M12				229	230
	Ar-82/CO ₂ -21 M21				233	234		Ar-82/CO ₂ -21 M21				233	234
CrNi Rutil / Basic	Ar-82/CO ₂ -21 M21				212	213	CrNi Rutil / Basic	Ar-82/CO ₂ -21 M21				212	213
	CO ₂ -100 / C1				212	213		CO ₂ -100 / C1				212	213

WPQR		
Streckenenergie energy per unit length	$E = \frac{P}{v_s}$	
000 kW : cm / sec = kJ/cm		
000 kW : mm / sec = kJ/mm		
Stahl	mild steel	
Edelstahl	stainless steel	
Aluminium	aluminium	

Art.-Nr.: 094-021066-00500

Figure 11-1

12 Appendix B

12.1 Overview of EWM branches

Headquarters

EWM AG
Dr. Günter-Henle-Straße 8
56271 Mündersbach · Germany
Tel: +49 2680 181-0 · Fax: -244
www.ewm-group.com · info@ewm-group.com

Technology centre

EWM AG
Forststraße 7-13
56271 Mündersbach · Germany
Tel: +49 2680 181-0 · Fax: -144
www.ewm-group.com · info@ewm-group.com



Production, Sales and Service

EWM AG
Dr. Günter-Henle-Straße 8
56271 Mündersbach · Germany
Tel: +49 2680 181-0 · Fax: -244
www.ewm-group.com · info@ewm-group.com

EWM HIGHTEC WELDING s.r.o.
9. května 718 / 31
407 53 Jirkov · Czech Republic
Tel: +420 412 358-551 · Fax: -504
www.ewm-jirkov.cz · info@ewm-jirkov.cz

EWM HIGH TECHNOLOGY (Kunshan) Ltd.
10 Yuanshan Road, Kunshan · New & Hi-tech Industry Development Zone
Kunshan City · Jiangsu · Post code 215300 · People's Republic of China
Tel: +86 512 57867-188 · Fax: -182
www.ewm.cn · info@ewm.cn · info@ewm-group.cn

Sales and Service Germany

EWM AG
Sales and Technology Centre
Grünauer Fenn 4
14712 Rathenow · Tel: +49 3385 49402-0 · Fax: -20
www.ewm-rathenow.de · info@ewm-rathenow.de

EWM HIGHTEC WELDING GmbH
Technology and mechanisation Centre
Daimlerstr. 4-6
69469 Weinheim · Tel: +49 6201 84557-0 · Fax: -20
www.ewm-weinheim.de · info@ewm-weinheim.de

EWM AG
Rudolf-Winkel-Straße 7-9
37079 Göttingen · Tel: +49 551-3070713-0 · Fax: -20
www.ewm-goettingen.de · info@ewm-goettingen.de

EWM Schweißtechnik Handels GmbH
Karlsdorfer Straße 43
88069 Tettngang · Tel: +49 7542 97998-0 · Fax: -29
www.ewm-tettngang.de · info@ewm-tettngang.de

EWM AG
Dieselstraße 9b
50259 Pulheim · Tel: +49 2238-46466-0 · Fax: -14
www.ewm-pulheim.de · info@ewm-pulheim.de

EWM Schweißtechnik Handels GmbH
Heinkelstraße 8
89231 Neu-Ulm · Tel: +49 731 7047939-0 · Fax: -15
www.ewm-neu-ulm.de · info@ewm-neu-ulm.de

EWM AG
August-Horch-Straße 13a
56070 Koblenz · Tel: +49 261 963754-0 · Fax: -10
www.ewm-koblenz.de · info@ewm-koblenz.de

EWM AG
Eiserfelder Straße 300
57080 Siegen · Tel: +49 271 3878103-0 · Fax: -9
www.ewm-siegen.de · info@ewm-siegen.de

Sales and Service International

EWM HIGH TECHNOLOGY (Kunshan) Ltd.
10 Yuanshan Road, Kunshan · New & Hi-tech Industry Development Zone
Kunshan City · Jiangsu · Post code 215300 · People's Republic of China
Tel: +86 512 57867-188 · Fax: -182
www.ewm.cn · info@ewm.cn · info@ewm-group.cn

EWM HIGHTEC WELDING UK Ltd.
Unit 2B Coopies Way · Coopies Lane Industrial Estate
Morpeth · Northumberland · NE61 6JN · Great Britain
Tel: +44 1670 505875 · Fax: -514305
www.ewm-morpeth.co.uk · info@ewm-morpeth.co.uk

EWM HIGHTEC WELDING GmbH
Wiesenstraße 27b
4812 Pilsdorf · Austria · Tel: +43 7612 778 02-0 · Fax: -20
www.ewm-austria.at · info@ewm-austria.at

EWM HIGHTEC WELDING Sales s.r.o. / Prodejní a poradenské centrum
Tyršova 2106
256 01 Benešov u Prahy · Czech Republic
Tel: +420 317 729-517 · Fax: -712
www.ewm-benesov.cz · info@ewm-benesov.cz

Liaison office Turkey

EWM AG Türkiye İrtibat Bürosu
İkitelli OSB Mah. · Marmara Sanayi Sitesi P Blok Apt. No: 44
Küçükçekmece / İstanbul Türkiye
Tel: +90 212 494 32 19
www.ewm-istanbul.com.tr · info@ewm-istanbul.com.tr

