



**EN**

**Control**

**T5.00 - AC/DC Comfort 3.0**

099-00T500-EW501

Observe additional system documents!

15.07.2021

**Register now  
and benefit!  
Jetzt Registrieren  
und Profitieren!**

[www.ewm-group.com](http://www.ewm-group.com)



## General instructions

### **WARNING**



#### **Read the operating instructions!**

**The operating instructions provide an introduction to the safe use of the products.**

- Read and observe the operating instructions for all system components, especially the safety instructions and warning notices!
- Observe the accident prevention regulations and any regional regulations!
- The operating instructions must be kept at the location where the machine is operated.
- Safety and warning labels on the machine indicate any possible risks. Keep these labels clean and legible at all times.
- The machine has been constructed to state-of-the-art standards in line with any applicable regulations and industrial standards. Only trained personnel may operate, service and repair the machine.
- Technical changes due to further development in machine technology may lead to a differing welding behaviour.

**In the event of queries on installation, commissioning, operation or special conditions at the installation site, or on usage, please contact your sales partner or our customer service department on +49 2680 181-0.**

**A list of authorised sales partners can be found at [www.ewm-group.com/en/specialist-dealers](http://www.ewm-group.com/en/specialist-dealers).**

Liability relating to the operation of this equipment is restricted solely to the function of the equipment. No other form of liability, regardless of type, shall be accepted. This exclusion of liability shall be deemed accepted by the user on commissioning the equipment.

The manufacturer is unable to monitor whether or not these instructions or the conditions and methods are observed during installation, operation, usage and maintenance of the equipment.

An incorrectly performed installation can result in material damage and injure persons as a result. For this reason, we do not accept any responsibility or liability for losses, damages or costs arising from incorrect installation, improper operation or incorrect usage and maintenance or any actions connected to this in any way.

#### **© EWM AG**

Dr. Günter-Henle-Strasse 8  
56271 Mündersbach Germany  
Tel.: +49 2680 181-0, Fax: -244  
Email: [info@ewm-group.com](mailto:info@ewm-group.com)  
**[www.ewm-group.com](http://www.ewm-group.com)**

The copyright to this document remains the property of the manufacturer.

Copying, including extracts, only permitted with written approval.

The content of this document has been prepared and reviewed with all reasonable care. The information provided is subject to change; errors excepted.

## 1

**Contents**

<b>1</b>	<b>Contents</b> .....	<b>3</b>
<b>2</b>	<b>For your safety</b> .....	<b>5</b>
2.1	Notes on using these operating instructions .....	5
2.2	Explanation of icons .....	6
2.3	Safety instructions.....	7
2.4	Transport and installation .....	10
<b>3</b>	<b>Intended use</b> .....	<b>12</b>
3.1	Software version .....	12
3.2	Use and operation solely with the following machines .....	12
3.3	Documents which also apply .....	13
3.3.1	Warranty .....	13
3.3.2	Declaration of Conformity .....	13
3.3.3	Welding in environments with increased electrical hazards .....	13
3.3.4	Service documents (spare parts and circuit diagrams) .....	13
3.3.5	Calibration/Validation.....	13
3.3.6	Part of the complete documentation.....	14
<b>4</b>	<b>Machine control – Operating elements</b> .....	<b>15</b>
4.1	Overview of control sections .....	15
4.1.1	Control section A .....	16
4.1.2	Control section B .....	18
4.1.3	Control section C .....	20
4.2	Machine display .....	21
4.3	Operating the machine control.....	21
4.3.1	Main screen .....	21
4.3.2	Setting the welding current (absolute/percentage).....	21
4.3.3	Welding parameter setting in the operation sequence .....	21
4.3.4	Setting advanced welding parameters (Expert menu) .....	22
4.3.5	Changing basic settings (machine configuration menu) .....	22
4.3.6	Lock function .....	22
<b>5</b>	<b>Functional characteristics</b> .....	<b>23</b>
5.1	TIG welding .....	23
5.1.1	Setting the shielding gas volume (gas test)/rinse hose package .....	23
5.1.1.1	Automatic gas post-flow .....	23
5.1.2	Welding task selection .....	24
5.1.3	Ignition correction .....	24
5.1.4	Manual ignition setting.....	25
5.1.4.1	Recurring welding tasks (JOB 1-100) .....	26
5.2	Welding programs.....	27
5.2.1	Selection and adjustment .....	27
5.2.2	Specifying max. no. of accessible programs .....	27
5.2.3	AC welding .....	28
5.2.3.1	Alternating current waveforms .....	28
5.2.3.2	Tungsten balling function .....	29
5.2.3.3	AC balance (optimise cleaning effect and penetration characteristics) .....	30
5.2.3.4	AC amplitude balance .....	30
5.2.3.5	Automatic AC frequency .....	31
5.2.3.6	AC commutation optimisation .....	32
5.2.4	Arc ignition .....	32
5.2.4.1	HF ignition .....	32
5.2.4.2	Liftarc .....	33
5.2.4.3	Automatic cut-out .....	33
5.2.5	Operating modes (functional sequences).....	34
5.2.5.1	Explanation of symbols .....	34
5.2.5.2	Non-latched mode .....	35
5.2.5.3	Latched mode .....	36
5.2.5.4	spotArc .....	37
5.2.5.5	spotmatic .....	38
5.2.5.6	Non-latched operation, version C .....	39

5.2.6	TIG activArc welding .....	40
5.2.7	TIG antistick .....	40
5.2.8	Pulse welding .....	41
5.2.9	Average value pulse welding .....	41
5.2.9.1	Thermal pulsing .....	42
5.2.9.2	Automated pulses .....	42
5.2.9.3	AC special .....	43
5.2.9.4	Pulsed welding in the upslope and downslope phases .....	43
5.2.10	Welding torch (operating variants) .....	44
5.2.10.1	Welding torch mode .....	44
5.2.10.2	Tapping function (tap torch trigger) .....	47
5.2.10.3	Up/down speed .....	47
5.2.10.4	Current jump .....	47
5.2.11	RTF 1 foot-operated remote control .....	48
5.2.11.1	RTF start ramp .....	48
5.2.11.2	RTF response .....	49
5.2.12	Expert menu (TIG) .....	50
5.2.13	Aligning the cable resistance .....	51
5.3	MMA welding .....	53
5.3.1	Welding task selection .....	53
5.3.2	Hotstart .....	53
5.3.2.1	Selection and adjustment .....	53
5.3.3	Arcforce .....	54
5.3.4	Antistick .....	54
5.3.5	Welding current polarity reversal (polarity reversal) .....	55
5.3.6	AC welding .....	55
5.3.6.1	Automatic AC frequency .....	55
5.3.7	Pulse welding .....	56
5.3.7.1	Average value pulse welding .....	56
5.4	Arc length restriction (USP) .....	56
5.5	JOB favourites .....	57
5.5.1	Saving current settings to Favourites .....	57
5.5.2	Loading saved Favourites .....	57
5.5.3	Deleting saved Favourites .....	58
5.6	Managing welding tasks (JOB manager) .....	58
5.6.1	Copying welding tasks (JOB) .....	58
5.6.2	Reset welding task (JOB) to the factory setting .....	59
5.7	Power-saving mode (Standby) .....	59
5.8	Access control .....	59
5.9	Voltage reducing device .....	60
5.10	Dynamic power adjustment .....	60
5.11	Machine configuration menu .....	61
5.11.1	Selecting, changing and saving parameters .....	61
<b>6</b>	<b>Rectifying faults .....</b>	<b>67</b>
6.1	Warnings .....	67
6.2	Error messages (power source) .....	69
6.3	Resetting welding parameters to the factory settings .....	72
6.4	Display machine control software version .....	72
<b>7</b>	<b>Appendix .....</b>	<b>73</b>
7.1	Parameter overview – setting ranges .....	73
7.1.1	TIG welding .....	73
7.1.1.1	Pulse parameters .....	74
7.1.1.2	AC parameters .....	74
7.1.2	MMA welding .....	74
7.1.2.1	Pulse parameters .....	75
7.1.2.2	AC parameters .....	75
7.1.3	Global parameters .....	75
7.2	Searching for a dealer .....	76

## 2 For your safety

### 2.1 Notes on using these operating instructions

#### **DANGER**

**Working or operating procedures which must be closely observed to prevent imminent serious and even fatal injuries.**

- Safety notes include the "DANGER" keyword in the heading with a general warning symbol.
- The hazard is also highlighted using a symbol on the edge of the page.

#### **WARNING**

**Working or operating procedures which must be closely observed to prevent serious and even fatal injuries.**

- Safety notes include the "WARNING" keyword in the heading with a general warning symbol.
- The hazard is also highlighted using a symbol in the page margin.

#### **CAUTION**

**Working or operating procedures which must be closely observed to prevent possible minor personal injury.**

- The safety information includes the "CAUTION" keyword in its heading with a general warning symbol.
- The risk is explained using a symbol on the edge of the page.



***Technical aspects which the user must observe to avoid material or equipment damage.***

Instructions and lists detailing step-by-step actions for given situations can be recognised via bullet points, e.g.:

- Insert the welding current lead socket into the relevant socket and lock.

## 2.2 Explanation of icons

Symbol	Description	Symbol	Description
	Indicates technical aspects which the user must observe.		Activate and release / Tap / Tip
	Switch off machine		Release
	Switch on machine		Press and hold
			Switch
	Incorrect / Invalid		Turn
	Correct / Valid		Numerical value – adjustable
	Input		Signal light lights up in green
	Navigation		Signal light flashes green
	Output		Signal light lights up in red
	Time representation (e.g.: wait 4 s / actuate)		Signal light flashes red
	Interruption in the menu display (other setting options possible)		
	Tool not required/do not use		
	Tool required/use		

## 2.3 Safety instructions

### **WARNING**



**Risk of accidents due to non-compliance with the safety instructions!**  
**Non-compliance with the safety instructions can be fatal!**

- Carefully read the safety instructions in this manual!
- Observe the accident prevention regulations and any regional regulations!
- Inform persons in the working area that they must comply with the regulations!



**Risk of injury from electrical voltage!**

**Voltages can cause potentially fatal electric shocks and burns on contact. Even low voltages can cause a shock and lead to accidents.**

- Never touch live components such as welding current sockets or stick, tungsten or wire electrodes!
- Always place torches and electrode holders on an insulated surface!
- Wear the full personal protective equipment (depending on the application)!
- The machine may only be opened by qualified personnel!
- The device must not be used to defrost pipes!



**Hazard when interconnecting multiple power sources!**

**If a number of power sources are to be connected in parallel or in series, only a technical specialist may interconnect the sources as per standard IEC 60974-9:2010: Installation and use and German Accident Prevention Regulation BVG D1 (formerly VBG 15) or country-specific regulations.**

**Before commencing arc welding, a test must verify that the equipment cannot exceed the maximum permitted open circuit voltage.**

- Only qualified personnel may connect the machine.
- When taking individual power sources out of operation, all mains and welding current leads must be safely disconnected from the welding system as a whole. (Hazard due to reverse polarity voltage!)
- Do not interconnect welding machines with pole reversing switch (PWS series) or machines for AC welding since a minor error in operation can cause the welding voltages to be combined, which is not permitted.



**Risk of injury due to radiation or heat!**

**Arc radiation can lead to skin and eye injuries.**

**Contact with hot workpieces and sparks can lead to burns.**

- Use hand shield or welding helmet with the appropriate safety level (depends on the application).
- Wear dry protective clothing (e.g. hand shield, gloves, etc.) in accordance with the applicable regulations of your country.
- Persons who are not directly involved should be protected with a welding curtain or suitable safety screen against radiation and the risk of blinding!

## **WARNING**



### **Risk of injury due to improper clothing!**

**During arc welding, radiation, heat and voltage are sources of risk that cannot be avoided. The user has to be equipped with the complete personal protective equipment at all times. The protective equipment has to include:**

- Respiratory protection against hazardous substances and mixtures (fumes and vapours); otherwise implement suitable measures such as extraction facilities.
- Welding helmet with proper protection against ionizing radiation (IR and UV radiation) and heat.
- Dry welding clothing (shoes, gloves and body protection) to protect against warm environments with conditions comparable to ambient temperatures of 100 °C or higher and arcing and work on live components.
- Hearing protection against harming noise.



### **Explosion risk!**

**Apparently harmless substances in closed containers may generate excessive pressure when heated.**

- Move containers with inflammable or explosive liquids away from the working area!
- Never heat explosive liquids, dusts or gases by welding or cutting!



### **Fire hazard!**

**Due to the high temperatures, sparks, glowing parts and hot slag that occur during welding, there is a risk of flames.**

- Be watchful of potential sources of fire in the working area!
- Do not carry any easily inflammable objects, e.g. matches or lighters.
- Ensure suitable fire extinguishers are available in the working area!
- Thoroughly remove any residue of flammable materials from the workpiece prior to starting to weld.
- Only further process workpieces after they have cooled down. Do not allow them to contact any flammable materials!



## ⚠ CAUTION



### Smoke and gases!

Smoke and gases can lead to breathing difficulties and poisoning. In addition, solvent vapour (chlorinated hydrocarbon) may be converted into poisonous phosgene due to the ultraviolet radiation of the arc!

- Ensure that there is sufficient fresh air!
- Keep solvent vapour away from the arc beam field!
- Wear suitable breathing apparatus if appropriate!



### Noise exposure!

Noise exceeding 70 dBA can cause permanent hearing damage!

- Wear suitable ear protection!
- Persons located within the working area must wear suitable ear protection!



According to IEC 60974-10, welding machines are divided into two classes of electromagnetic compatibility (the EMC class can be found in the Technical data):

**Class A** machines are not intended for use in residential areas where the power supply comes from the low-voltage public mains network. When ensuring the electromagnetic compatibility of class A machines, difficulties can arise in these areas due to interference not only in the supply lines but also in the form of radiated interference.



**Class B** machines fulfil the EMC requirements in industrial as well as residential areas, including residential areas connected to the low-voltage public mains network.



### Setting up and operating

When operating arc welding systems, in some cases, electro-magnetic interference can occur although all of the welding machines comply with the emission limits specified in the standard. The user is responsible for any interference caused by welding.

In order to **evaluate** any possible problems with electromagnetic compatibility in the surrounding area, the user must consider the following: (see also EN 60974-10 Appendix A)

- Mains, control, signal and telecommunication lines
- Radios and televisions
- Computers and other control systems
- Safety equipment
- The health of neighbouring persons, especially if they have a pacemaker or wear a hearing aid
- Calibration and measuring equipment
- The immunity to interference of other equipment in the surrounding area
- The time of day at which the welding work must be carried out

### Recommendations for reducing interference emission

- Mains connection, e.g. additional mains filter or shielding with a metal tube
- Maintenance of the arc welding system
- Welding leads should be as short as possible and run closely together along the ground
- Potential equalization
- Earthing of the workpiece. In cases where it is not possible to earth the workpiece directly, it should be connected by means of suitable capacitors.
- Shielding from other equipment in the surrounding area or the entire welding system



### Electromagnetic fields!

The power source may cause electrical or electromagnetic fields to be produced which could affect the correct functioning of electronic equipment such as IT or CNC devices, telecommunication lines, power cables, signal lines and pacemakers.



- Observe the maintenance instructions!
- Unwind welding leads completely!
- Shield devices or equipment sensitive to radiation accordingly!
- The correct functioning of pacemakers may be affected (obtain advice from a doctor if necessary).

## CAUTION



### Obligations of the operator!

**The respective national directives and laws must be complied with when operating the machine!**

- Implementation of national legislation relating to framework directive 89/391/EEC on the introduction of measures to encourage improvements in the safety and health of workers at work and associated individual guidelines.
- In particular, directive 89/655/EEC concerning the minimum safety and health requirements for the use of work equipment by workers at work.
- The regulations applicable to occupational safety and accident prevention in the country concerned.
- Setting up and operating the machine as per IEC 60974.-9.
- Brief the user on safety-conscious work practices on a regular basis.
- Regularly inspect the machine as per IEC 60974.-4.



***The manufacturer's warranty becomes void if non-genuine parts are used!***

- ***Only use system components and options (power sources, welding torches, electrode holders, remote controls, spare parts and replacement parts, etc.) from our range of products!***
- ***Only insert and lock accessory components into the relevant connection socket when the machine is switched off.***

### Requirements for connection to the public mains network

High-performance machines can influence the mains quality by taking current from the mains network. For some types of machines, connection restrictions or requirements relating to the maximum possible line impedance or the necessary minimum supply capacity at the interface with the public network (Point of Common Coupling, PCC) can therefore apply. In this respect, attention is also drawn to the machines' technical data. In this case, it is the responsibility of the operator, where necessary in consultation with the mains network operator, to ensure that the machine can be connected.

## 2.4 Transport and installation

## WARNING



### Risk of injury due to improper handling of shielding gas cylinders!

**Improper handling and insufficient securing of shielding gas cylinders can cause serious injuries!**

- Observe the instructions from the gas manufacturer and any relevant regulations concerning the use of compressed air!
- Do not attach any element to the shielding gas cylinder valve!
- Prevent the shielding gas cylinder from heating up.

**⚠ CAUTION****Risk of accidents due to supply lines!**

**During transport, attached supply lines (mains leads, control cables, etc.) can cause risks, e.g. by causing connected machines to tip over and injure persons!**

- Disconnect all supply lines before transport!

**Risk of tipping!**

**There is a risk of the machine tipping over and injuring persons or being damaged itself during movement and set up. Tilt resistance is guaranteed up to an angle of 10° (according to IEC 60974-1).**

- Set up and transport the machine on level, solid ground.
- Secure add-on parts using suitable equipment.

**Risk of accidents due to incorrectly installed leads!**

**Incorrectly installed leads (mains, control and welding leads or intermediate hose packages ) can present a tripping hazard.**

- Lay the supply lines flat on the floor (avoid loops).
- Avoid laying the leads on passage ways.

**Risk of injury from heated coolant and its connections!**

**The coolant used and its connection or connection points can heat up significantly during operation (water-cooled version). When opening the coolant circuit, escaping coolant may cause scalding.**

- Open the coolant circuit only when the power source or cooling unit is switched off!
- Wear proper protective equipment (protective gloves)!
- Seal open connections of the hose leads with suitable plugs.



***The units are designed for operation in an upright position!***

***Operation in non-permissible positions can cause equipment damage.***

- ***Only transport and operate in an upright position!***



***Accessory components and the power source itself can be damaged by incorrect connection!***

- ***Only insert and lock accessory components into the relevant connection socket when the machine is switched off.***
- ***Comprehensive descriptions can be found in the operating instructions for the relevant accessory components.***
- ***Accessory components are detected automatically after the power source is switched on.***



***Protective dust caps protect the connection sockets and therefore the machine against dirt and damage.***

- ***The protective dust cap must be fitted if there is no accessory component being operated on that connection.***
- ***The cap must be replaced if faulty or if lost!***

## 3 Intended use

### **WARNING**



#### **Hazards due to improper usage!**

The machine has been constructed to the state of the art and any regulations and standards applicable for use in industry and trade. It may only be used for the welding procedures indicated at the rating plate. Hazards may arise for persons, animals and material objects if the equipment is not used correctly. No liability is accepted for any damages arising from improper usage!

- The equipment must only be used in line with its designated purpose and by trained or expert personnel!
- Do not improperly modify or convert the equipment!

### 3.1 Software version

These instructions apply to the following software version:

0.1.0.0

The software version of the machine control can be displayed in the machine configuration menu (menu *Srv*) > see 5.11 chapter.

### 3.2 Use and operation solely with the following machines

- Tetrix XQ 230 puls AC/DC

### 3.3 Documents which also apply

#### 3.3.1 Warranty

For more information refer to the "Warranty registration" brochure supplied and our information regarding warranty, maintenance and testing at [www.ewm-group.com](http://www.ewm-group.com)!

#### 3.3.2 Declaration of Conformity



This product corresponds in its design and construction to the EU directives listed in the declaration. The product comes with a relevant declaration of conformity in the original.

The manufacturer recommends carrying out the safety inspection according to national and international standards and guidelines every 12 months.

#### 3.3.3 Welding in environments with increased electrical hazards



Power sources with this marking can be used for welding in an environment with increased electrical hazard (e.g. boilers). For this purpose, appropriate national or international regulations must be followed. The power source must not be placed in the danger zone!

#### 3.3.4 Service documents (spare parts and circuit diagrams)

##### **WARNING**



**Do not carry out any unauthorised repairs or modifications!**

**To avoid injury and equipment damage, the unit must only be repaired or modified by specialist, skilled persons!**

**The warranty becomes null and void in the event of unauthorised interference.**

- Appoint only skilled persons for repair work (trained service personnel)!

Original copies of the circuit diagrams are enclosed with the unit.

Spare parts can be obtained from the relevant authorised dealer.

#### 3.3.5 Calibration/Validation

An original certificate is enclosed with the product. The manufacturer recommends calibration / validation at intervals of 12 months.

### 3.3.6 Part of the complete documentation

This document is part of the complete documentation and valid only in combination with all other parts of these instructions! Read and observe the operating instructions for all system components, especially the safety instructions!

The illustration shows a general example of a welding system.

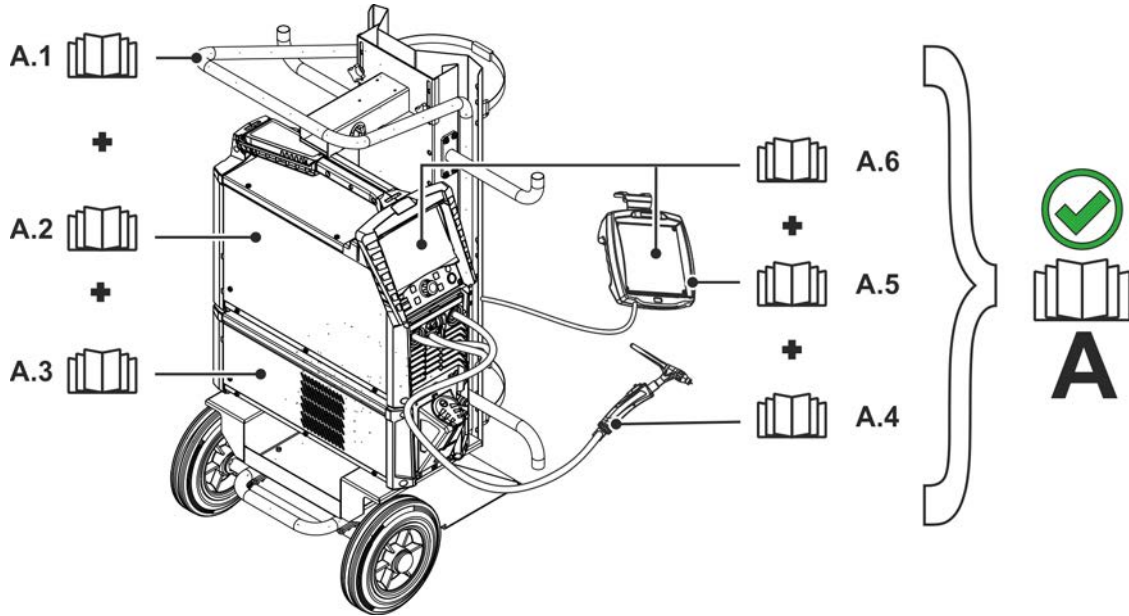

Figure 3-1

Item	Documentation
A.1	Transport vehicle
A.2	Power source
A.3	Cooling unit
A.4	Welding torch
A.5	Remote control
A.6	Control
A	Complete documentation

## 4 Machine control – Operating elements

### 4.1 Overview of control sections

For description purposes, the machine control has been divided into three sections (A, B, C) to ensure maximum clarity. The setting range for the parameter values are summarised in the parameter overview section > see 7.1 chapter.

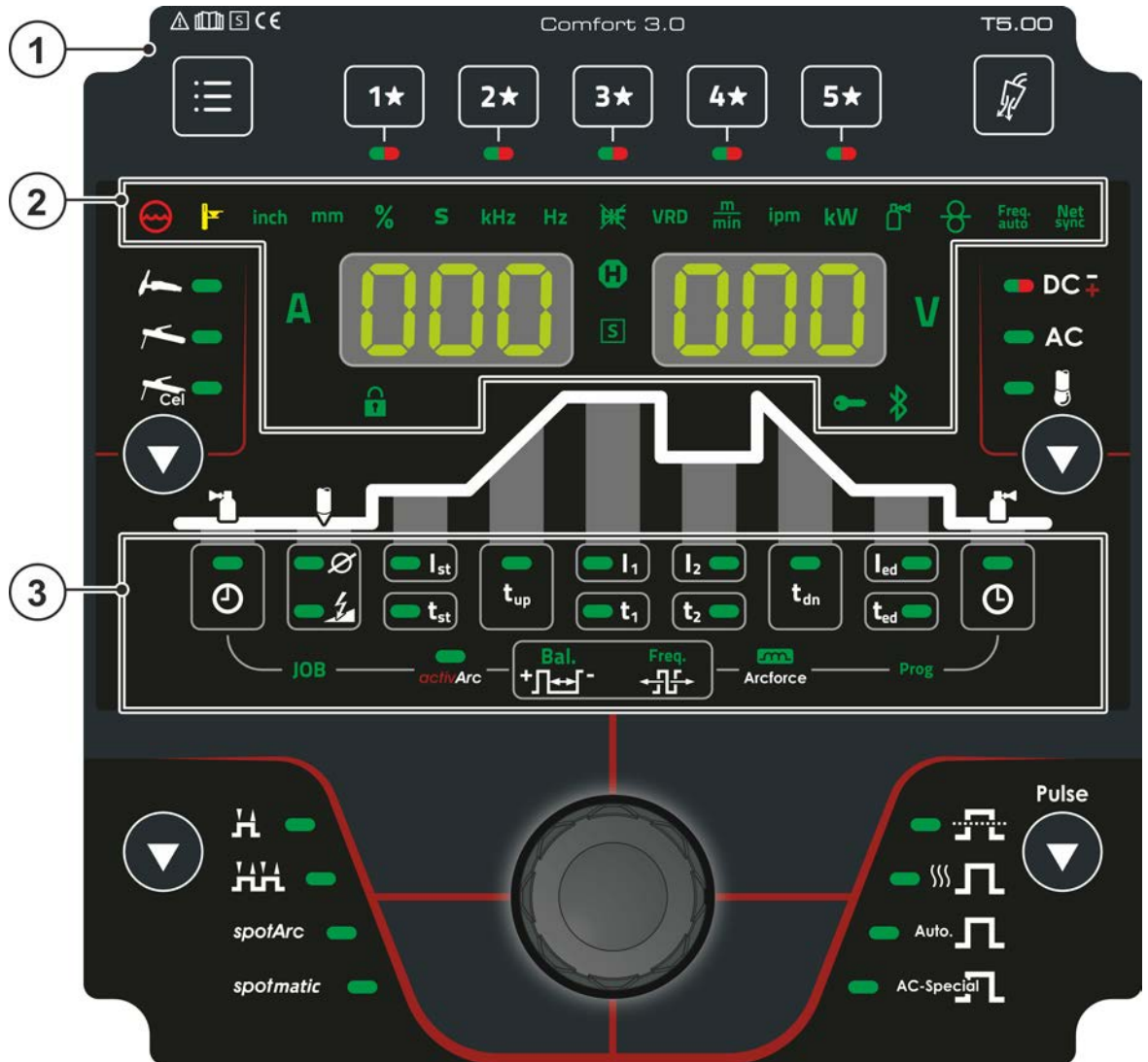

Figure 4-1

Item	Symbol	Description
1		Control section A > see 4.1.1 chapter
2		Control section B > see 4.1.2 chapter
3		Control section C > see 4.1.3 chapter

## 4.1.1 Control section A

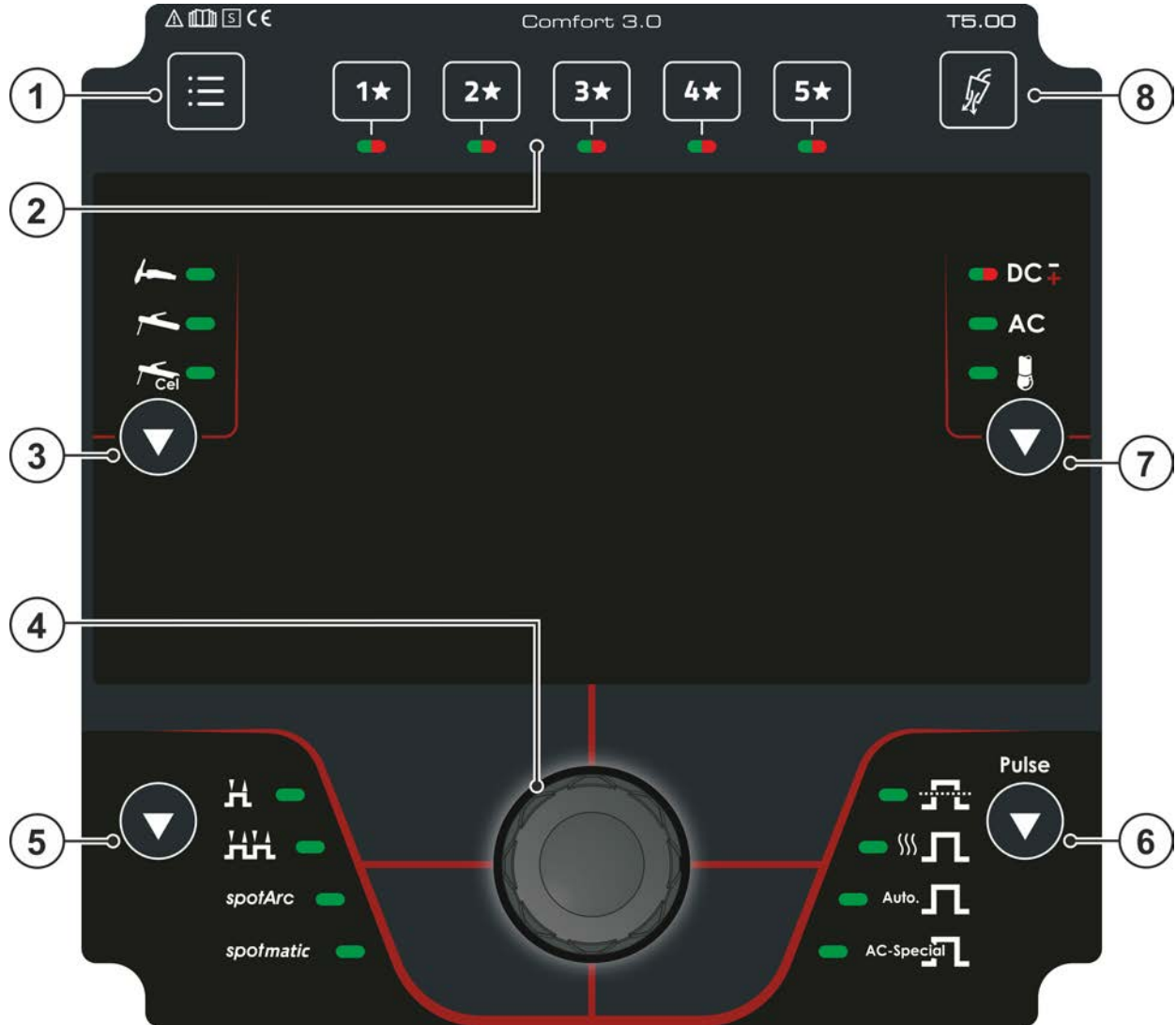













Figure 4-2

Item	Symbol	Description
1		<b>System push-button</b> <ul style="list-style-type: none"> <li>----- Quick access to various device configuration parameters. For the complete parameter list, see the machine configuration menu &gt; see 5.11 chapter</li> <li>----- Lock function - protection against accidental adjustment &gt; see 4.3.6 chapter</li> </ul>
2		<b>push-button - JOB Favourites &gt; see 5.5 chapter</b> <ul style="list-style-type: none"> <li>----- Pressing the push-button briefly: Loading Favourites</li> <li>----- Press and hold the push-button (&gt;2 s): Saving as a Favourite</li> <li>----- Press and hold the push-button (&gt;12 s): Deleting a Favourite</li> </ul>
3		<b>Push-button for welding procedure</b> <ul style="list-style-type: none"> <li>----- TIG-welding</li> <li>----- MMA welding</li> <li>----- MMA Cel welding (characteristics for cellulose electrode)</li> </ul>
4		<b>Click wheel</b> <ul style="list-style-type: none"> <li>----- Setting the welding power</li> <li>----- Navigate through menu and parameters</li> <li>----- Setting the parameter values depending on the preselection.</li> </ul>



Item	Symbol	Description
5		<p><b>Push-button for operating modes &gt; see 5.2.5 chapter</b></p> <p>-----Latched  -----Non-latched</p> <p><b>spotArc</b> - Spot welding procedure spotArc  <b>spotmatic</b> Spot welding procedure spotmatic</p>
6		<p><b>Pulsing push-button &gt; see 5.2.8 chapter</b></p> <p>-----Average value pulsing  -----Thermal pulsing  Auto. -----Automated pulsing  AC-Special -----AC special</p>
7		<p><b>Push-button for welding current polarity / tungsten balling</b></p> <p><b>DC</b> -----DC welding with either negative or positive polarity on the welding torch or electrode holder (activation in the machine configuration menu is required for TIG-DC+).</p> <p><b>AC</b>-----AC welding / AC forms &gt; see 5.2.3.1 chapter  -----Tungsten balling &gt; see 5.2.3.2 chapter</p>
8		<p><b>Push-button gas test / rinse hose package &gt; see 5.1.1 chapter</b></p>

## 4.1.2 Control section B

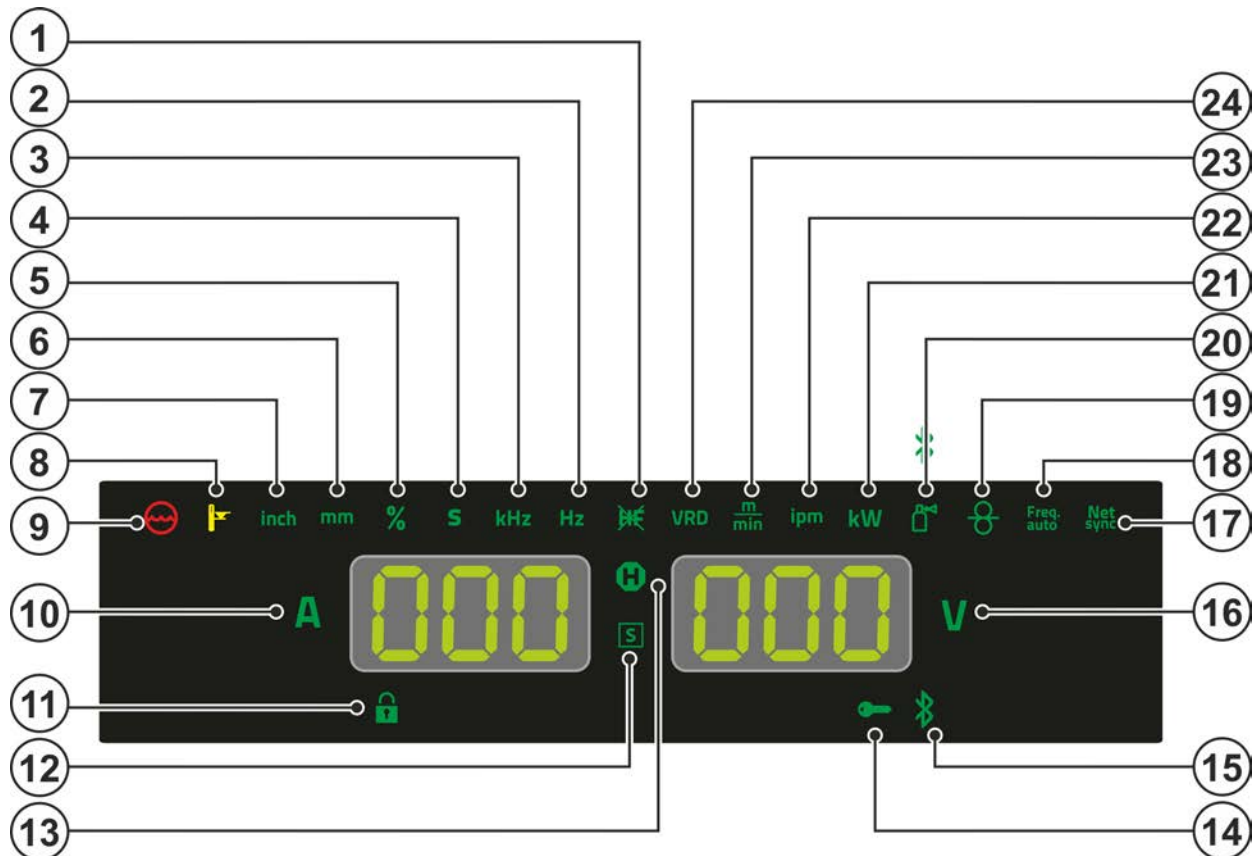







Figure 4-3

Item	Symbol	Description
1		<b>TIG ignition type signal light</b> Signal light on: Lift arc ignition active/HF start off. You can switch the ignition type in the Expert menu (TIG) > see 5.2.4 chapter.
2	Hz	<b>Signal light - display value in hertz</b>
3	kHz	<b>Signal light - display value in kilohertz</b>
4	S	<b>Signal light - display value in seconds</b>
5	%	<b>Signal light - display value in per cent</b>
6	mm	<b>Signal light - display value in millimetres</b>
7	inch	<b>Signal light - display value in inch</b>
8		<b>Excess temperature signal light</b> In case of excess temperature, temperature monitors de-activate the power unit, and the excess temperature control lamp comes on. Once the machine has cooled down, welding can continue without any further measures.
9		<b>Coolant fault signal light</b> Signals pressure loss or low coolant level in the coolant circuit.
10	A	<b>Welding current signal light</b> Display of the welding current in amperes.
11		<b>Signal light for lock function &gt; see 4.3.6 chapter</b>
12		<b>Character  function signal light</b> Indicates that it is possible to weld in an environment with major electric hazards, such as in boilers. Service must be informed if this signal light is not on.

Item	Symbol	Description
13		<b>Signal light for status display</b> After each completed welding process, the last values used for welding current and voltage are shown in the displays and the signal light is on.
14		<b>Access control active signal light</b> Signal light is on when access control is active on the machine control > see 5.8 chapter.
15		<b>Without function in this machine version.</b>
16		<b>Signal light welding voltage</b> Illuminates when the welding voltage is displayed in volts.
17		<b>Without function in this machine version.</b>
18		<b>Automatic AC frequency &gt; see 5.2.3.5 chapter</b>
19		<b>Without function in this machine version.</b>
20		<b>Without function in this machine version.</b>
21		<b>Without function in this machine version.</b>
22	ipm	<b>Signal light - display value in Inches per minute</b>
23		<b>Signal light - display value in metres per minute</b>
24	VRD	<b>Voltage reduction device (VRD) signal light &gt; see 5.9 chapter</b>

## 4.1.3 Control section C

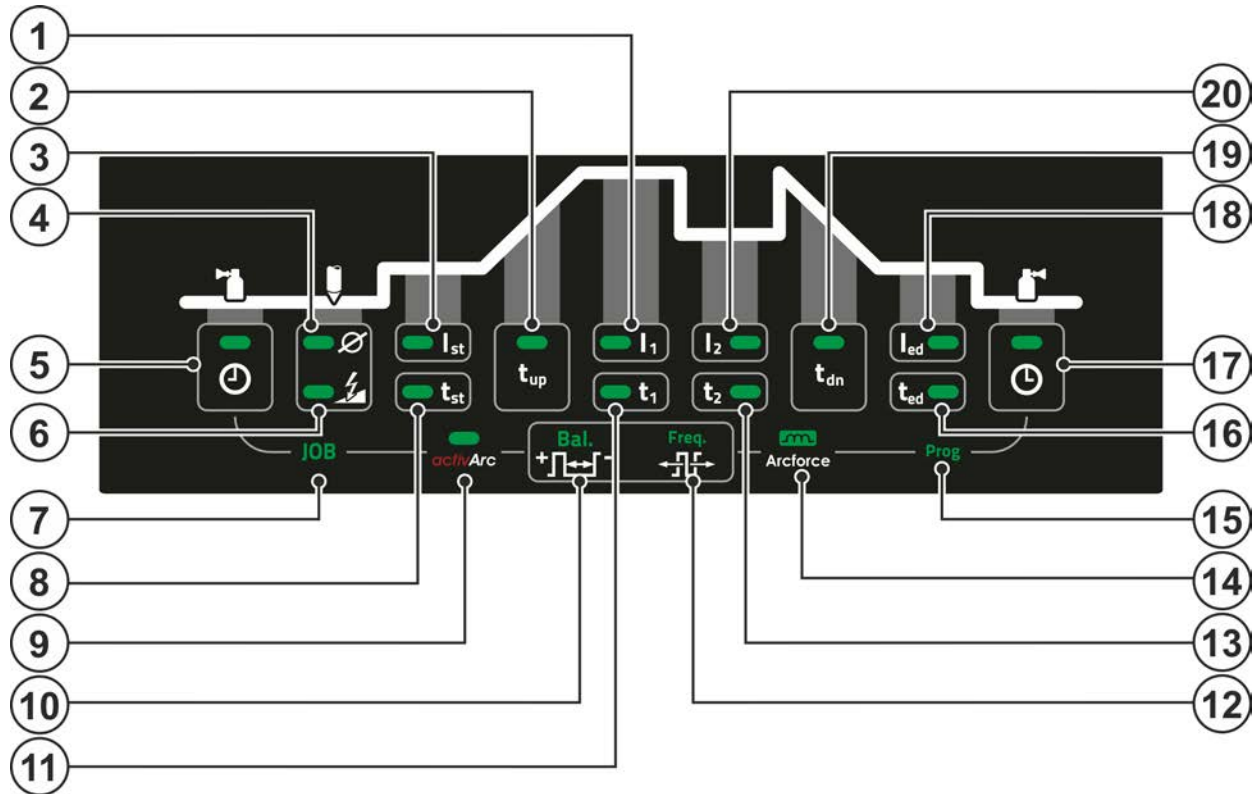

Figure 4-4

Item	Symbol	Description
1	$I_1$	Signal light for main current $[I_1]$ / pulse current $[PL]$
2	$t_{up}$	Signal light for up-slope time $[EUP]$
3	$I_{st}$	Signal light for ignition current $[I_{St}]$
4	$\emptyset$	Signal light for electrode diameter $[ndR]$
5		Gas pre-flow time signal light $[GPR]$
6		Signal light for ignition optimisation (TIG) $[COR]$
7	JOB	Signal light for welding task (JOB)
8	$t_{st}$	Signal light for ignition current time $[ESt]$
9	activArc	Signal light activArc $[RR]$ > see 5.2.6 chapter
10	Bal. 	Signal light for balance $[BAL]$
11	$t_1$	Signal light for pulse time $[E1]$
12	Freq. 	Signal light for frequency $[FrE]$
13	$t_2$	Signal light for pulse time $[E2]$
14	Arcforce 	Signal light for Arcforce (welding characteristics) > see 5.3.3 chapter
15	Prog	Signal light for the welding program > see 5.2 chapter Display of the current program number in the welding data display.
16	$t_{ed}$	Signal light for end current time $[EEd]$
17		Gas post-flow time $[GPE]$
18	$I_{ed}$	Signal light for end current $[IEd]$
19	$t_{dn}$	Signal light for down-slope time $[Edn]$

Item	Symbol	Description
20	I <sub>2</sub>	Signal light for secondary current

## 4.2 Machine display

The following welding parameters can be displayed before (nominal values), during (actual values) or after welding (hold values). The display of the hold values is indicated by the signal light :

Parameter	Before welding (nominal values)	During welding (actual values)	After welding (hold values)
Welding current		[2]	[3]
Parameter times			
Parameter currents			
Frequency, balance			
JOB number			
Welding voltage	[1]		

[1] not for MMA welding

[2] The actual value display of the welding current for MMA can be switched on or off with the parameter .

[3] The behaviour of the hold value display can be set with the parameters for TIG and for MMA.

The settings are made in the machine configuration menu > see 5.11 chapter.

The parameters that can be set in the function sequence of the machine control depend on the selected welding task. This means that if for example you have not selected a pulse variant, then you cannot set any pulse times in the function sequence.

## 4.3 Operating the machine control

### 4.3.1 Main screen

After switching on the machine or finishing a setting, the machine control changes to the main screen. This means that the previously selected settings are accepted (if necessary, indicated by signal lights) and the nominal value of the current (A) is shown in the welding data display on the left. The welding data display on the right shows the nominal value for the preselected welding voltage (V). The control changes back to the main screen after 4 s.

### 4.3.2 Setting the welding current (absolute/percentage)

The welding current is set with the control button (click wheel).

The welding current can be set as a percentage (of the main current) or an absolute value:

TIG: Start, secondary and end current

MMA: Hot start current

To select, use the parameter > see 5.11 chapter in the configuration menu.

### 4.3.3 Welding parameter setting in the operation sequence

Set a welding parameter in the functional sequence by clicking (select) and turning the click wheel (navigate to the desired parameter). Press again to apply the selected parameter as the setting (corresponding parameter value and signal light flash). Then turn to set the parameter value.

During welding parameter setting, the parameter value to be set flashes in the left hand display. A parameter abbreviation or a deviation in the specified parameter value upwards or downwards is shown on the right-hand display:

Display	Meaning
	<b>Increase the parameter value</b> To return to the factory settings.
	<b>Factory setting (example value = 20)</b> Parameter is set to optimum value
	<b>Decrease the parameter value</b> To return to the factory settings.

## 4.3.4 Setting advanced welding parameters (Expert menu)

The Expert menu contains functions and parameters that cannot be set directly on the machine control or for which regular settings are not required. The number and display of these parameters depend on the previously selected welding procedure or functions.

To select, press and hold the click wheel (> 2 s). Select the appropriate parameter / menu item by turning (navigating) and pressing (confirming) the click wheel.

## 4.3.5 Changing basic settings (machine configuration menu)

The basic welding system functions can be adjusted in the machine configuration menu. Only experienced users should change the settings > see 5.11 chapter.

## 4.3.6 Lock function

The lock function protects against accidental changes to the machine settings. All operating elements are deactivated when the function is activated and the signal light of the lock function is on. Press and hold (> 2 s) the push-button  to enable or disable the function.

## 5 Functional characteristics

### 5.1 TIG welding

#### 5.1.1 Setting the shielding gas volume (gas test)/rinse hose package

- Slowly open the gas cylinder valve.
- Open the pressure regulator.
- Switch on the power source at the main switch.
- Set the relevant gas quantity for the application on the pressure regulator.
- Press the push-button "gas test / flush"  to activate the gas test > see 5.1.1 chapter.

Setting the shielding gas quantity (gas test)

- Shielding gas flows for 20 s or until the push-button is pressed again.

Purging long hose packages (purging)

- Press push-button for about 5 s. • Shielding gas flows for approx. 5 min. or until the push-button is pressed again.

If the shielding gas setting is too low or too high, this can introduce air to the weld pool and may cause pores to form. Adjust the shielding gas quantity to suit the welding task!

**Setting instructions: The gas nozzle diameter in mm corresponds to the gas flow in l/min.**

**Helium-rich gas mixtures require a higher gas volume!**

The table below can be used to correct the gas volume calculated where necessary:



Shielding gas	Factor
75% Ar/25% He	1.14
50% Ar/50% He	1.35
25% Ar/75% He	1.75
100% He	3.16

**For connecting the shielding gas supply and handling the shielding gas cylinder refer to the power source operating instructions.**

#### 5.1.1.1 Automatic gas post-flow

When the function is enabled, the machine control adjusts the gas post-flow time depending on the output. The adjustable gas post-flow time relates to the maximum possible current of the power source and decreases linearly.

Example: With the automatic gas post-flow function enabled, a gas post-flow time of 10 s has been set. This means that with a welding current of 230 A, the gas post-flow time is 10 s. At a welding current of 115 A, the gas post-flow time is reduced to 5 s.

The automatic gas post-flow function  can be enabled or disabled in the machine configuration menu > see 5.11 chapter. With the function enabled, the parameters  and  for automatic are displayed alternately when the gas post-flow time is selected.





### 5.1.4 Manual ignition setting

When the special ignition is selected, the dependency of the minimum current limits on the electrode diameter is disabled. The ignition energy can now be set independently with the parameters ignition current  $I_c$  and ignition time  $I_t$ . The ignition time is set absolutely in milliseconds. The setting of the ignition current differs in the setting variants  $SP1$  and  $SP2$ .

- In the variant  $SP1$ , the ignition current is set absolutely in ampere [A].
- In the variant  $SP2$ , the ignition current is set as a percentage of the set main current.

The parameters for manual setting of the ignition energy are selected and enabled with "left stop" when setting the electrode diameter (minimum value >  $SP1$  >  $SP2$ ).

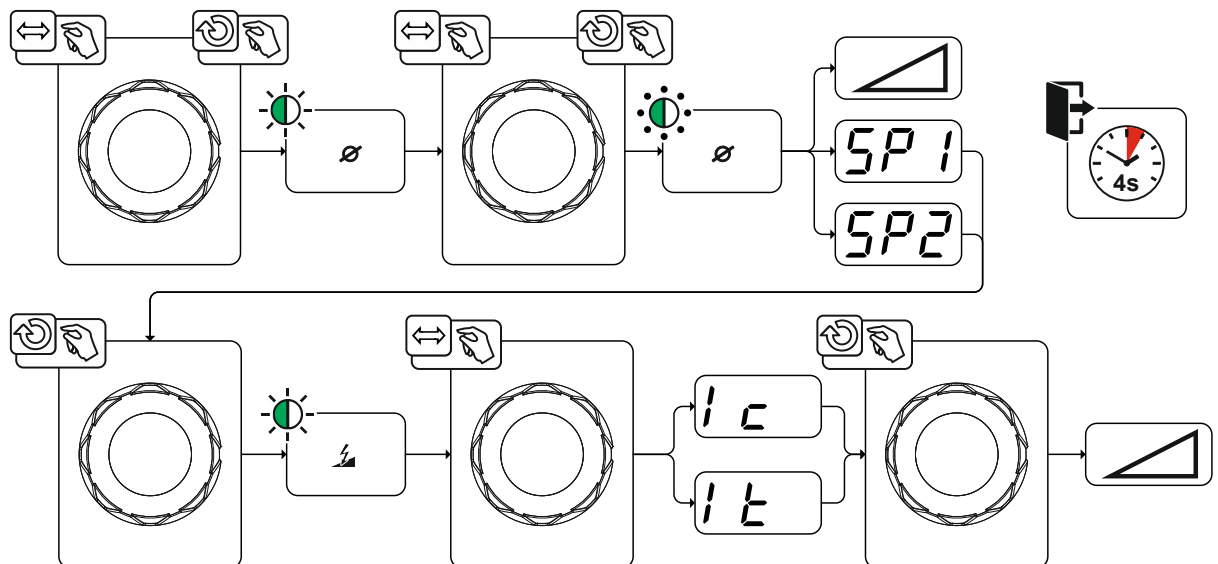

Figure 5-3

## 5.1.4.1 Recurring welding tasks (JOB 1-100)

The user has 100 additional memory locations at their disposal to save recurring or different welding tasks on a permanent basis. To do so, simply select the required memory location (JOB 1-100) and set the welding task as described previously.

With the JOB manager > see 5.6 chapter, welding tasks can be copied to any preset or reset to the factory settings.

The desired JOB can also be assigned to a quick access button (favourites button) > see 5.5 chapter.

Switching a JOB is only possible if no welding current flows. Up-slope and down-slope times can be set individually for latched and non-latched operation.

### Selection

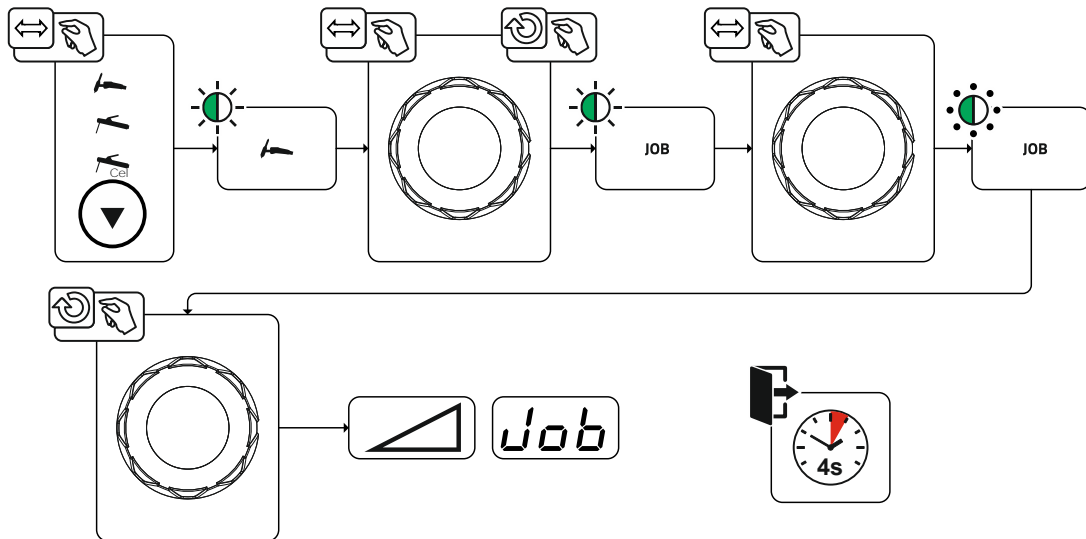

Figure 5-4

When one or more of the recurring welding tasks has been selected, the JOB signal light comes on.



## 5.2.3 AC welding

The welding of aluminium and aluminium alloys is made possible by the periodic change of polarity on the tungsten electrode.

The negative pole (negative half-wave) of the tungsten electrode determines the penetration characteristics and has a lower electrode load compared to the positive half-wave. The negative half-wave is also called "cold half-wave".

Whereas the positive polarity, i.e. the positive half-wave, breaks up the oxide layer on the material surface (the so-called cleaning effect). At the same time, the tungsten electrode tip melts into a ball (the so-called balled end) due to the high thermal effect of the positive half-wave. The size of the balled end depends on the length (balance setting > see 5.2.3.3 chapter) and the current amplitude (amplitude balance > see 5.2.3.4 chapter) of the positive phase. It should be noted that a balled end that is too large may lead to an unstable and diffuse arc resulting in a low penetration profile. Therefore, the relationship between the current amplitude and the balance of the task must be adjusted accordingly.

### 5.2.3.1 Alternating current waveforms

#### Selection

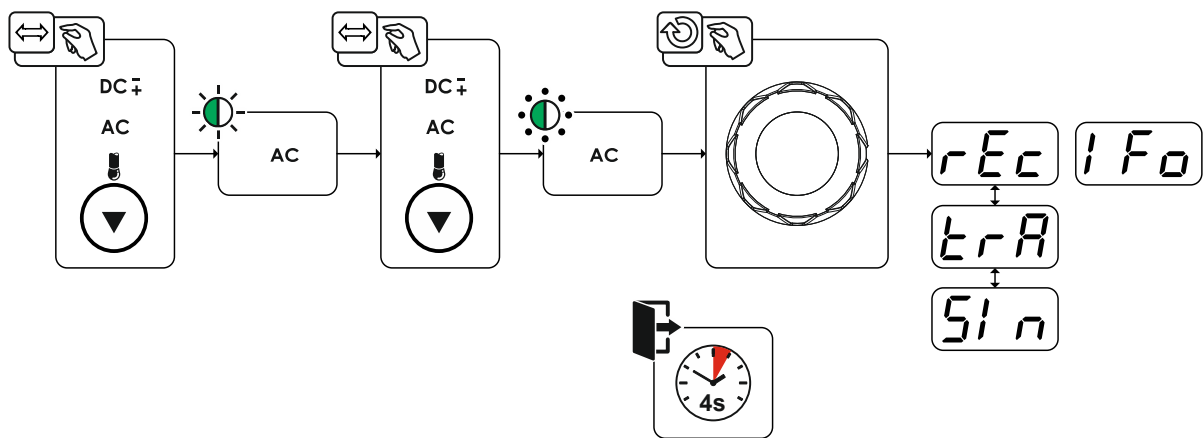

Figure 5-6

Display	Setting/selection
<b>IFo</b>	<b>Alternating current waveforms <sup>1</sup></b>
<b>rEc</b>	----- Rectangular - Highest energy input (ex works)
<b>tRn</b>	----- Trapezoidal - An all-rounder, suitable for most applications
<b>Si n</b>	----- Sine - Low noise level

<sup>1</sup> for AC welding machines only.

## 5.2.3.2 Tungsten balling function

The tungsten balling function achieves an optimal balled end enabling the best ignition and welding results for AC welding.

Optimal tungsten balling requires a sharpened electrode (about 15–25 °) and the set electrode diameter on the machine control. The set electrode diameter affects the current used for tungsten balling and thus the balled end size.

The function is enabled by pressing the push-button tungsten balling and indicated by the flashing of the corresponding signal light. If required, this current can be adjusted individually using the  $I_{\text{C}}$  parameter (+/- 30 A).

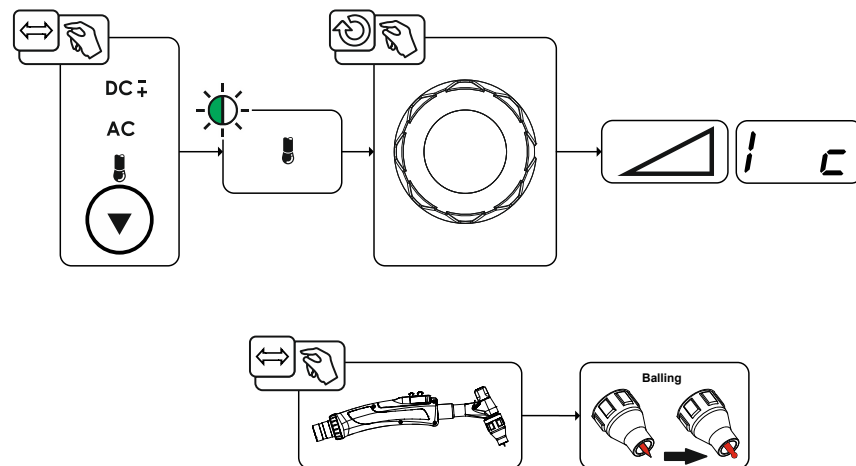

The user presses the torch trigger and the function is started by non-contact ignition (HF start). The balled end is formed and the function automatically terminated after the gas post-flow time has elapsed.

The tungsten balling should be carried out on a test component as any excess tungsten is melted off possibly leading to impurities on the weld seam.

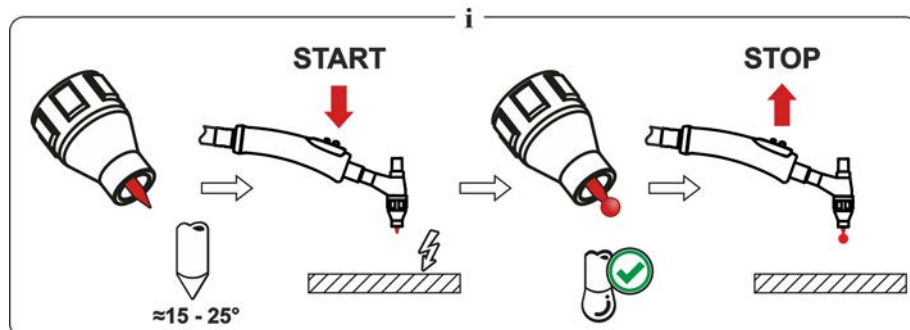

Figure 5-7

### 5.2.3.3 AC balance (optimise cleaning effect and penetration characteristics)

It is important to choose the right time relationship (balance) between the positive phase (cleaning effect, beaded end size) and the negative phase (penetration depth). This may differ from the factory setting depending on the material and task. This requires the AC balance setting. The default setting (factory setting, zero setting) of the balance is 65 % and always refers to the negative half-wave. The positive half-wave is adjusted accordingly (negative half-wave = 65 %, positive half-wave = 35 %).

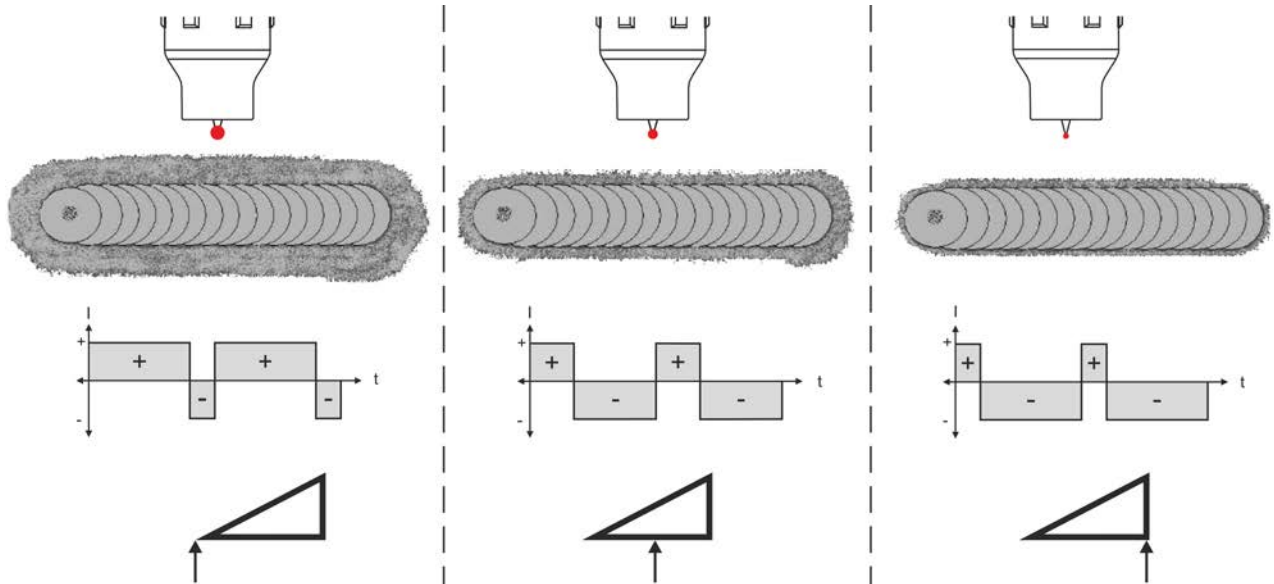

Figure 5-8

### 5.2.3.4 AC amplitude balance

As with AC balance, durations (balance) for positive phase and negative phase are set for AC amplitude balance. The balance changes in terms of the current amplitude.

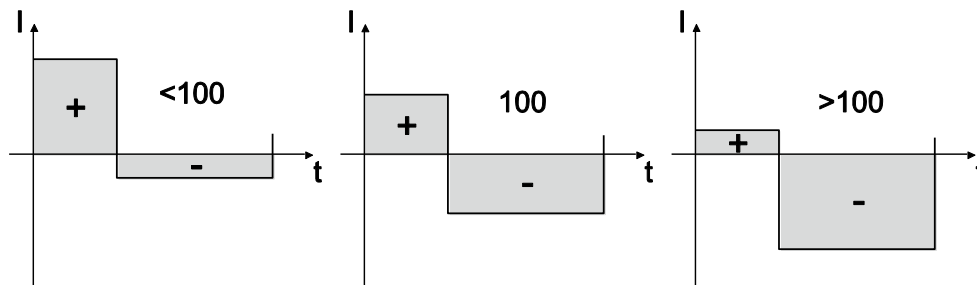

Figure 5-9

The AC amplitude balance can be set in the Expert menu (TIG) using parameter  $\overline{RbA}$  > see 5.2.12 chapter.

**Increasing the current amplitude in the positive half-wave facilitates the cleaning effect and the cracking of the oxide layer.**

**Raising the negative current amplitude increases the penetration.**

### 5.2.3.5 Automatic AC frequency

Activation takes place in the functional sequence using the parameter frequency  $f_{\text{Aut}}$ . By turning to the left, the parameter value is reduced until the parameter **Aut** (AC frequency automatic) is shown in the display. The signal light  $f_{\text{Auto}}$  comes on when the function is enabled.

The machine control takes over the regulation or setting of the alternating current frequency depending on the set main current. The lower the welding current, the higher the frequency and vice versa. This achieves a concentrated, directionally stable arc when welding currents are low. The load on the tungsten electrode is minimised when the welding currents are high ensuring a longer service life.

The use of a foot-operated remote control with this function reduces manual intervention by the user during the welding process to a minimum.

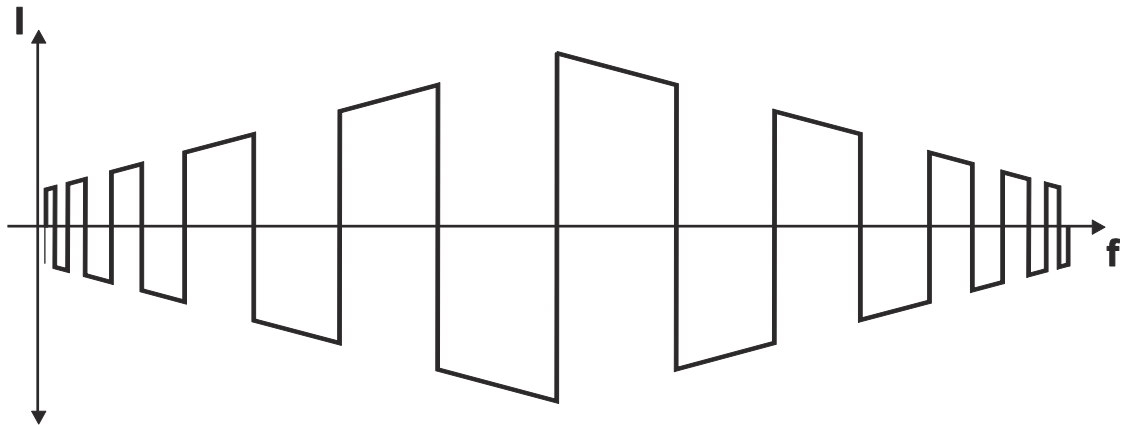

Figure 5-10

### Selection

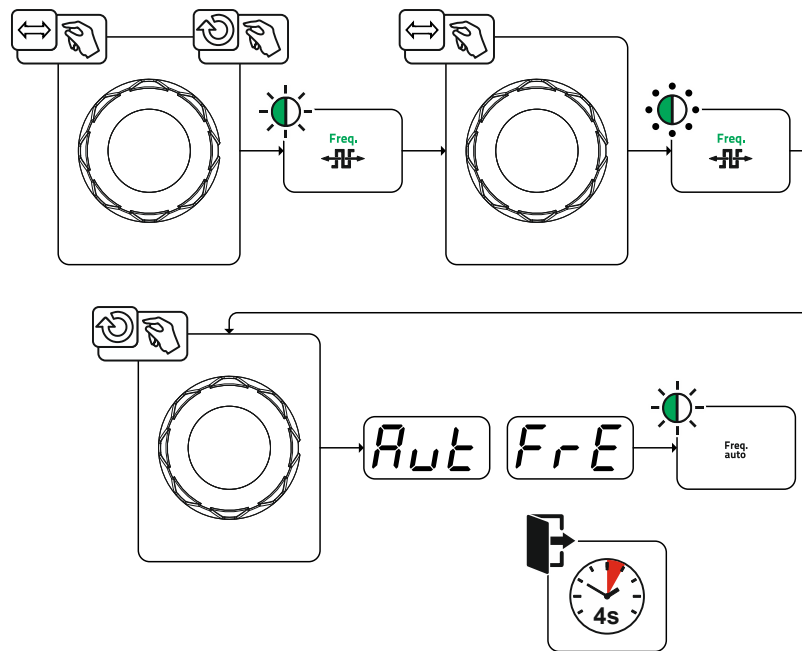

Figure 5-11

## 5.2.3.6 AC commutation optimisation

With AC welding, a periodic change between positive and negative half-wave takes place. This pole change is called commutation. External influences such as low-alloy aluminium materials (such as Al 99.5) or gases that are difficult to ionize (Ar/He mixtures) may compromise the commutation and lead to lower arc stability and higher noise levels.

The power source has intelligent commutation optimization that is divided into automatic operation (left stop) and manual operation (1- 100):

- Automatic mode (factory setting)  
The commutation optimisation is set to “Auto” as standard. The power source can therefore evaluate the commutation and automatically ensures the highest possible arc stability, safe penetration and oxide-free seams for every welding task. Automatic mode is the preferred choice for almost every application.
- Manual mode (1-100):  
If the result in automatic mode is not satisfactory in rare cases, the commutation optimisation can be adjusted in manual mode. In this case, the following schematic representation can be used as a setting aid.



Figure 5-12

## 5.2.4 Arc ignition

The type of ignition (parameter  $hF$ ) can be set in the system menu (push-button  $\equiv$ ). The HF intensity (parameter  $hFL$ ) can be adjusted in the machine configuration menu if necessary > see 5.11 chapter.

### 5.2.4.1 HF ignition

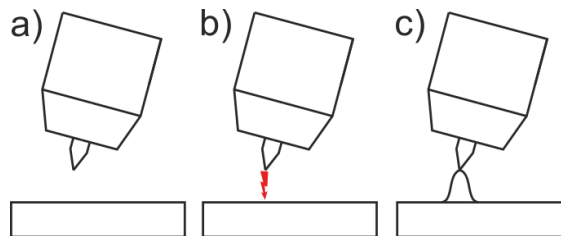

Figure 5-13

**The arc is started without contact from high-voltage ignition pulses.**

- Position the welding torch in welding position over the workpiece (distance between the electrode tip and workpiece should be approx. 2-3mm).
- Press the torch trigger (high voltage ignition pulses ignite the arc).
- Ignition current flows, and the welding process is continued depending on the operating mode selected.

**End the welding process: Release or press the torch trigger depending on the operating mode selected.**



### 5.2.4.2 Liftarc

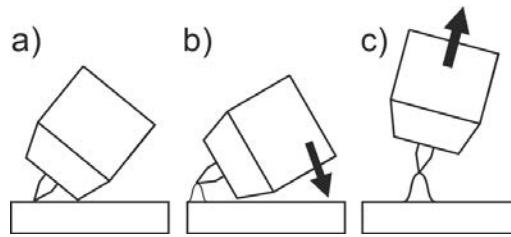

Figure 5-14

The arc is ignited on contact with the workpiece:

- a) Carefully place the torch gas nozzle and tungsten electrode tip onto the workpiece and press the torch trigger (liftarc current flowing, regardless of the main current set).
- b) Incline the torch over the torch gas nozzle to produce a gap of approx. 2-3 mm between the electrode tip and the workpiece. The arc ignites and the welding current is increased, depending on the operating mode set, to the ignition or main current set.
- c) Lift off the torch and swivel to the normal position.

Ending the welding process: Release or press the torch trigger depending on the operating mode selected.

### 5.2.4.3 Automatic cut-out





Once the fault periods have elapsed, the automatic cut-out stops the welding process when it has been triggered by one of two states:

- During ignition  
5 s after the start of the welding process, no welding current flows (ignition error).
- During welding  
The arc is interrupted for more than 5 s (arc interruption).

You can disable or set the time for re-ignition after an arc interruption in the machine configuration menu > see 5.11 chapter (parameter  $\overline{VLR}$ ).

## 5.2.5 Operating modes (functional sequences)

### 5.2.5.1 Explanation of symbols

Symbol	Meaning
	Press torch trigger 1
	Release torch trigger 1
I	Current
t	Time
	Gas pre-flow
	Ignition current
	Start time
	Up-slope time
	Spot time
<b>AMP</b>	Main current (minimum to maximum current)
<b>AMP%</b>	Secondary current
	Pulse time
	Pulse pause time
	Pulse current
	Latched operating mode: Slope time from main current (AMP) to secondary current (AMP%) TIG - thermal pulsing: Slope time from pulse current to pulse pause current
	Latched operating mode: Slope time from secondary current (AMP%) to main current (AMP) TIG - thermal pulsing: Slope time from pulse pause current to pulse current
	Down-slope time
	End-crater current
	End-crater time
	Gas post-flow
	Balance
	Frequency

## 5.2.5.2 Non-latched mode Sequence

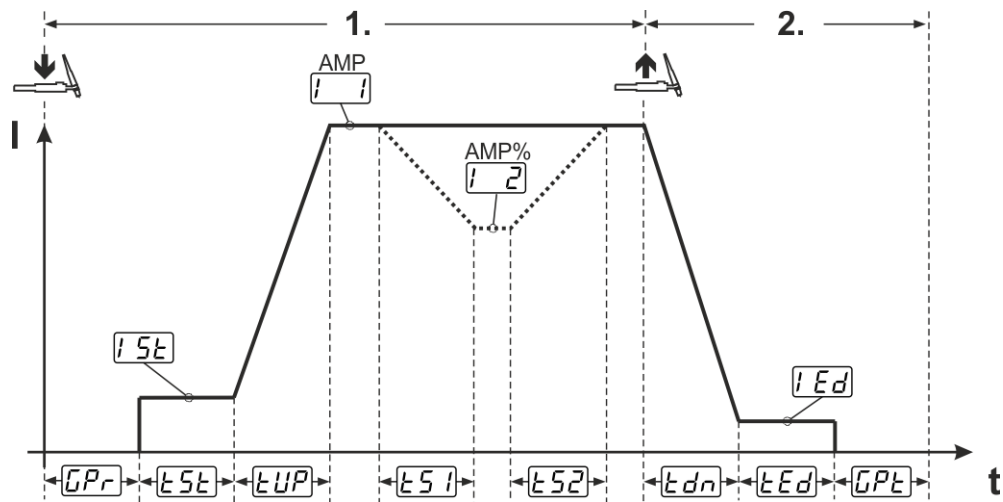

Figure 5-15

### 1st cycle:

- Press torch trigger 1 and hold down.
- Gas pre-flow time  $t_{Pr}$  elapses.
- HF ignition pulses jump from the electrode to the workpiece. The arc ignites.
- The welding current flows and immediately assumes the value of the ignition current  $I_{St}$ .
- HF switches off.
- The welding current ramps up to the main current  $I$  (AMP) in the selected up-slope time  $t_{UP}$ .

If torch trigger 2 is pressed together with torch trigger 1 during the main current phase, the welding current decreases to the secondary current  $I_2$  (AMP%) in the set slope time  $t_{S1}$ .

If torch trigger 2 is released, the welding current increases again to the main current AMP in the set slope time  $t_{S2}$ . The parameters  $t_{S1}$  and  $t_{S2}$  can be set in the Expert menu (TIG) > see 5.2.12 chapter.

### 2nd cycle:

- Release torch trigger 1.
- The main current falls to the end-crater current  $I_{Ed}$  (minimum current) in the set down-slope time  $t_{Dn}$ .

If the 1st torch trigger is pressed during the down-slope time, the welding current returns to the set main current AMP

- Main current reaches the end-crater current  $I_{Ed}$ ; the arc is extinguished.
- Set gas post-flow time  $t_{Pt}$  elapses.

When the foot-operated remote control is connected, the machine switches automatically to non-latched operation. The up- and down-slopes are switched off.

## 5.2.5.3 Latched mode Sequence

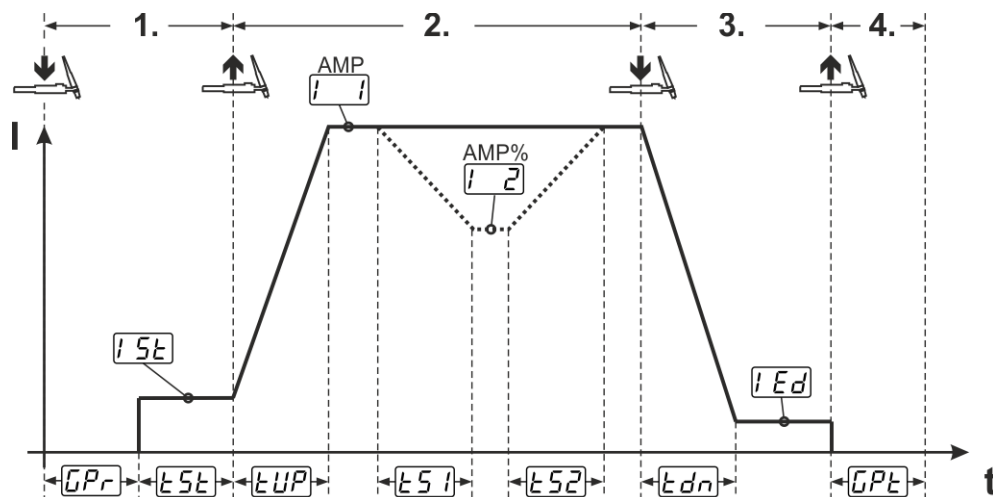

Figure 5-16

### 1st cycle

- Press torch trigger 1  $\overline{GPr}$ , the gas pre-flow time elapses.
- HF start pulses jump from the electrode to the workpiece. The arc ignites.
- Welding current flows and immediately assumes the set ignition current  $\overline{iSt}$  (search arc at minimum setting). HF switches off.
- Ignition current flows at least for the start time  $\overline{tSt}$  or as long as the torch trigger is held.

### 2nd cycle

- Release torch trigger 1.
- The welding current ramps up to the main current  $\overline{i}$  (AMP) in the selected upslope time  $\overline{tUP}$ .

### Switching from the main current AMP to secondary current $\overline{i2}$ (AMP%):

- Press torch trigger 2 or
- Tap torch trigger 1 (torch modes 1–6).

If torch trigger 2 is pressed together with torch trigger 1 during the main current phase, the welding current decreases to the secondary current  $\overline{i2}$  (AMP%) in the set slope time  $\overline{tS1}$ .

Once torch trigger 2 is released, the welding current increases again to the main current AMP in the set slope time  $\overline{tS2}$ . The parameters  $\overline{tS1}$  and  $\overline{tS2}$  can be set in the Expert menu (TIG) > see 5.2.12 chapter.

### 3rd cycle

- Press torch trigger 1.
- The main current decreases to the end-crater current  $\overline{iEd}$  within the set down-slope time  $\overline{tdn}$ .

Once the main current phase  $\overline{i}$  AMP has been reached, you can shorten the welding sequence by tapping torch trigger 1 (third cycle will be omitted).

### 4th cycle

- Release torch trigger 1; arc is extinguished.
- Set gas post-flow time  $\overline{GPt}$  runs.

When the foot-operated remote control is connected, the machine switches automatically to non-latched operation. The up- and down-slopes are switched off.

### Alternative welding start (tapping start):

For the alternative welding start, the durations of the first and second cycle are defined by the set process times only (tapping the torch trigger in the gas pre-low phase  $\overline{GPr}$ ).

To activate this function, set a two-digit torch mode (11-1x) at the machine control. This function can also be deactivated completely when required (welding stop by tapping remains active). To do so, the  $\overline{tPS}$  parameter must be switched to  $\overline{OFF}$  in the machine configuration menu > see 5.11 chapter.

## 5.2.5.4 spotArc

This process is suitable for tack welding or joint welding of metal sheets made from steel and CrNi alloys up to a thickness of approximately 2.5 mm. Metal sheets of different thicknesses can also be welded on top of one another. As this is a one-sided process, it is also possible to weld metal sheets onto tubular sections such as round or square pipes. In arc spot welding, the arc melts through the upper metal sheet and the lower metal sheet is melted onto it. This produces flat, fine-textured welding tacks which require little or no post weld work, even in visible areas.

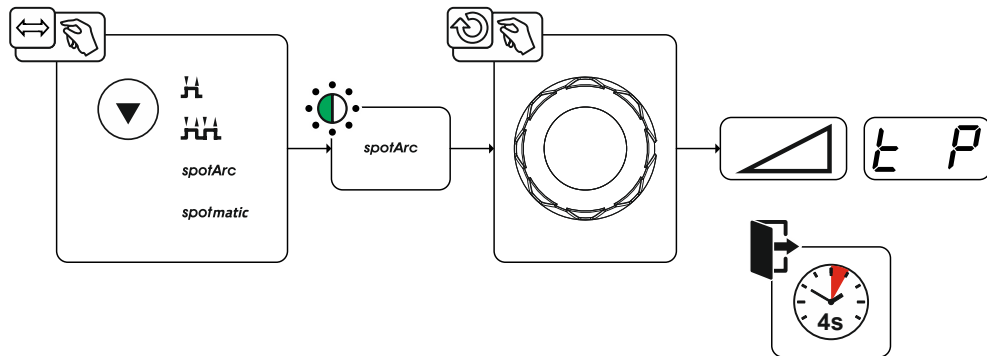

Figure 5-17

The up-slope and down-slope times should be set to "0" to achieve an effective result.

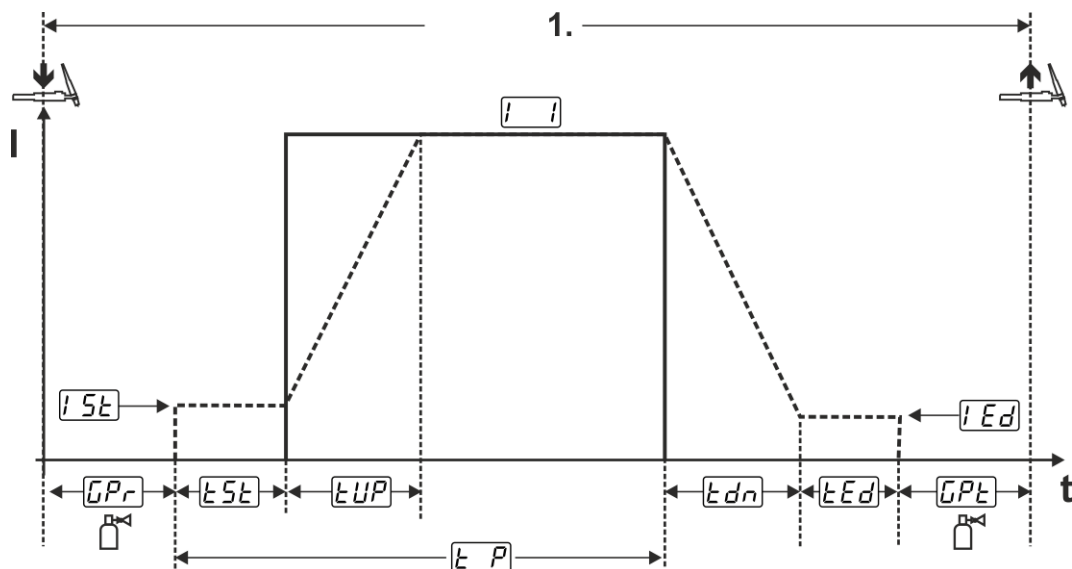

Figure 5-18

As an example the process is shown with HF ignition. Arc ignition with lift arc is also possible, however > see 5.2.4 chapter.

### Sequence:

- Press torch trigger and hold down.
- The gas pre-flow time elapses.
- HF start pulses jump from the electrode to the workpiece. The arc ignites.

The welding current flows and immediately assumes the value of the ignition current  $I_{5t}$

- HF switches off.
- The welding current ramps up to the main current  $I$  (AMP) within the set up-slope time  $t_{UP}$ .

The process ends when the set spotArc.time elapses or by releasing the torch trigger. With the spotArc function enabled, the Automatic Puls pulse variant is activated as well. If required, the function can be disabled by pressing the pulsed welding push-button.

## 5.2.5.5 spotmatic

In contrast to the spotArc operating mode, the arc is not ignited by pressing the torch trigger as is usual, but by briefly touching the tungsten electrode against the workpiece. The torch trigger is used for welding process activation. Activation is indicated by flashing of the spotArc/spotmatic signal light. The process can be activated separately for each spot or also on a permanent basis. The setting is controlled using the  $\overline{55P}$  process activation parameter in the configuration menu > see 5.11 chapter.

- Separate process activation ( $\overline{55P} > \overline{on}$ ):  
The welding process has to be reactivated for every arc ignition by pressing the torch trigger. Process activation is automatically terminated after 30 s of inactivity.
- Permanent process activation ( $\overline{55P} > \overline{off}$ ):  
The welding process is activated by pressing the torch trigger once. The following arc ignitions are initiated by shortly touching the tungsten electrode against the workpiece. Process activation is terminated either by pressing the torch trigger again or automatically after 30 s of inactivity.

For spotmatic the separate process activation and the short spot time setting range are enabled by default.

Ignition by touching the tungsten electrode against the workpiece can be disabled in the machine configuration menu with parameter  $\overline{5P7}$ . In this case the function works as with spotArc, but the spot time setting range can be selected in the machine configuration menu.

The duration is set in the machine configuration menu using parameter  $\overline{5t5}$  > see 5.11 chapter

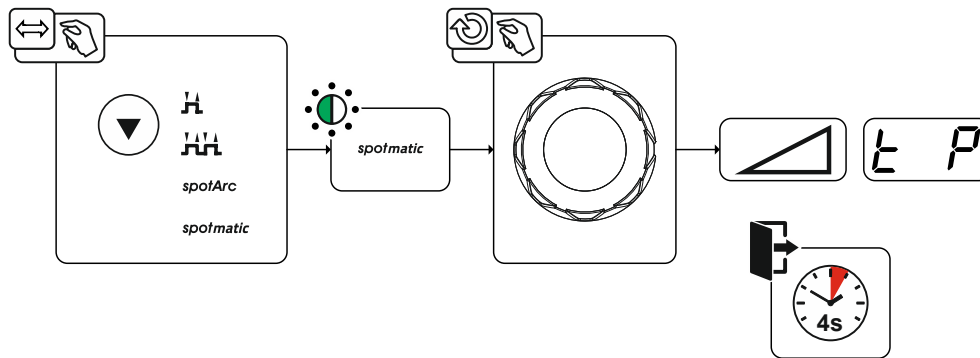

Figure 5-19

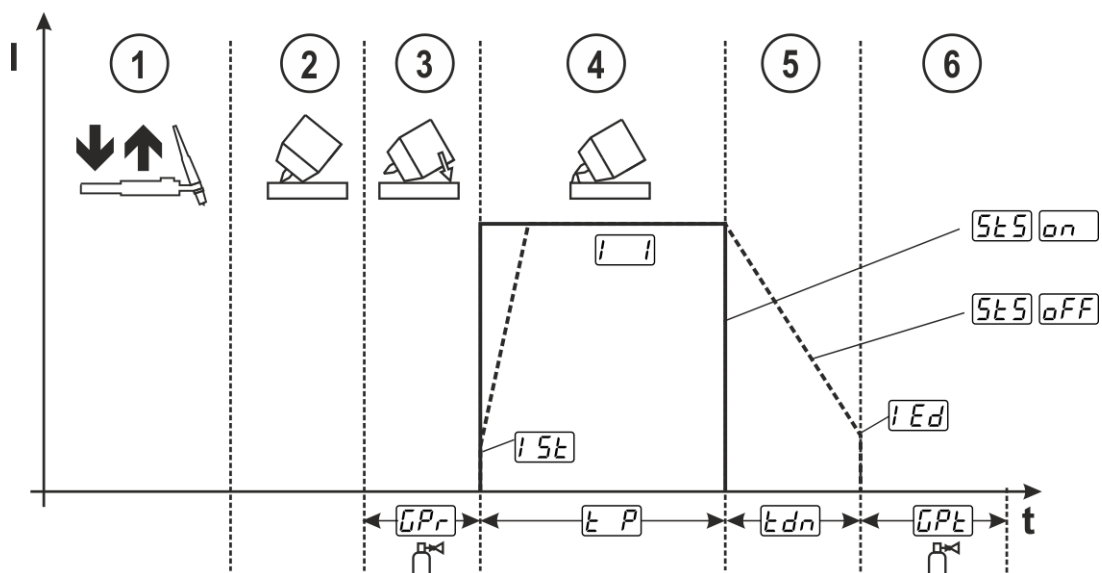

Figure 5-20

As an example the process is shown with HF ignition. Arc ignition with lift arc is also possible, however > see 5.2.4 chapter.

**Selecting the process activation type for the welding process > see 5.11 chapter.**

**Up-slope and down-slope times possible for long spot time setting range (0.01–20.0 s) only.**

- ① Press and release torch trigger (tap) to activate the welding process.
- ② Touch the torch gas nozzle and tungsten electrode tip carefully against the workpiece.
- ③ Incline the welding torch over the torch gas nozzle until there is a gap of approx. 2–3 mm between the electrode tip and the workpiece. Shielding gas flows during the set gas pre-flow time  $\overline{GPr}$ . The arc ignites and the previously set ignition current  $\overline{ISt}$  flows.
- ④ The main current phase  $\overline{I}$  ends when the set  $\overline{tP}$  spot time elapses.
- ⑤ For long-time spot welding only (parameter  $\overline{StS} = \overline{OFF}$ ):  
The welding current decreases to the end-crater current  $\overline{IEd}$  within the set down-slope time  $\overline{tdn}$ .
- ⑥ The gas post-flow time  $\overline{GPE}$  elapses and the welding process ends.

**Press and release the torch trigger (tap) to reactivate the welding process (only for separate process activation). Touching the welding torch with the tungsten electrode tip against the workpiece again will initiate the next welding processes.**

#### 5.2.5.6 Non-latched operation, version C

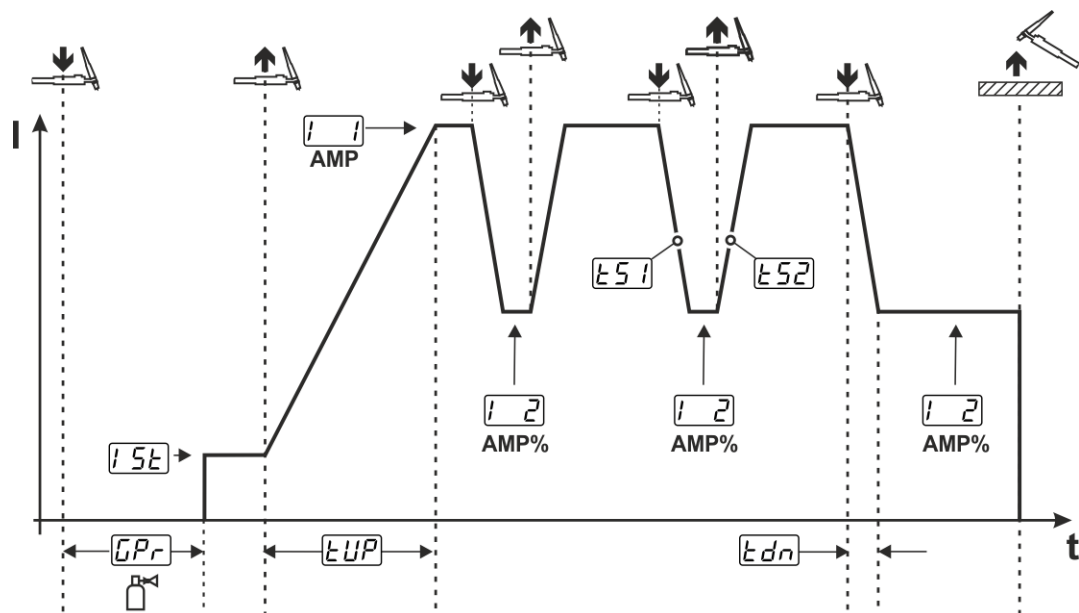

Figure 5-21

#### 1st cycle

- Press torch trigger 1  $\overline{GPr}$ , the gas pre-flow time elapses.
- HF ignition pulses jump from the electrode to the workpiece. The arc ignites.
- Welding current flows and immediately assumes the set ignition current  $\overline{ISt}$  (search arc at minimum setting). HF switches off.

#### 2nd cycle

- Release torch trigger 1.
- The welding current ramps up to the main current AMP in the selected up-slope time  $\overline{tUP}$ .

Pressing torch trigger 1 starts the slope  $\overline{tS1}$  from main current AMP to secondary current  $\overline{I2}$  AMP%.

Releasing the torch trigger starts the slope  $\overline{tS2}$  from the secondary current AMP% and back to the main current AMP. This process can be repeated as frequently as required.

The welding process is stopped by interrupting the arc in the secondary current (remove the welding torch from the workpiece until the arc is extinguished, no re-ignition).

The slope times  $\overline{tS1}$  and  $\overline{tS2}$  can be set in the Expert menu > see 5.2.12 chapter.

**This operating mode must be enabled (parameter  $\overline{tEc}$ ) > see 5.11 chapter.**





## 5.2.8 Pulse welding

The following pulse types can be selected:

- Average value pulsing (TIG AC up to 5 Hz and WIG DC up to 20 kHz)
- Thermal pulsing (TIG AC or TIG DC)
- Automated pulsing (TIG DC)
- AC special (TIG AC)

## 5.2.9 Average value pulse welding

A special feature with average value pulses is that the power source will always maintain the preset average value. This makes this method especially suitable for welding according to welding procedure specifications.

For average value pulsing, switching takes place periodically between two currents whereby an average current value (AMP), a pulse current ( $I_{puls}$ ), pulse balance ( $\overline{bRL}$ ) and pulse frequency ( $\overline{FrE}$ ) must be specified. The set average current value in ampere is decisive; the pulse current ( $I_{puls}$ ) is specified with the parameter  $\overline{IPL}$  as a percentage of the average current (AMP).

The pulse pause current (IPP) is not set. This value is calculated by the machine control to ensure that the average value of the welding current (AMP) is maintained.

With the parameter  $\overline{PF0}$ , the waveform of the pulse can be adapted in the Expert menu to the existing welding task. Especially in the lower frequency range, the adjustable pulse shapes show their effect on the arc characteristics (only TIG DC).

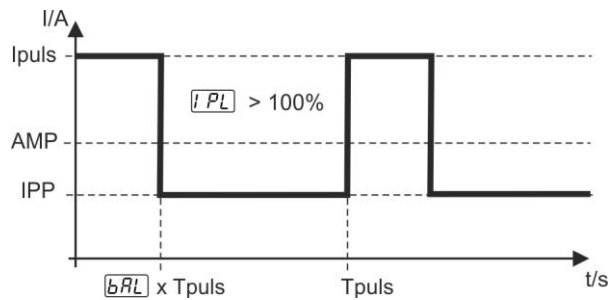

Figure 5-23

### Setting the pulse frequency and pulse balance

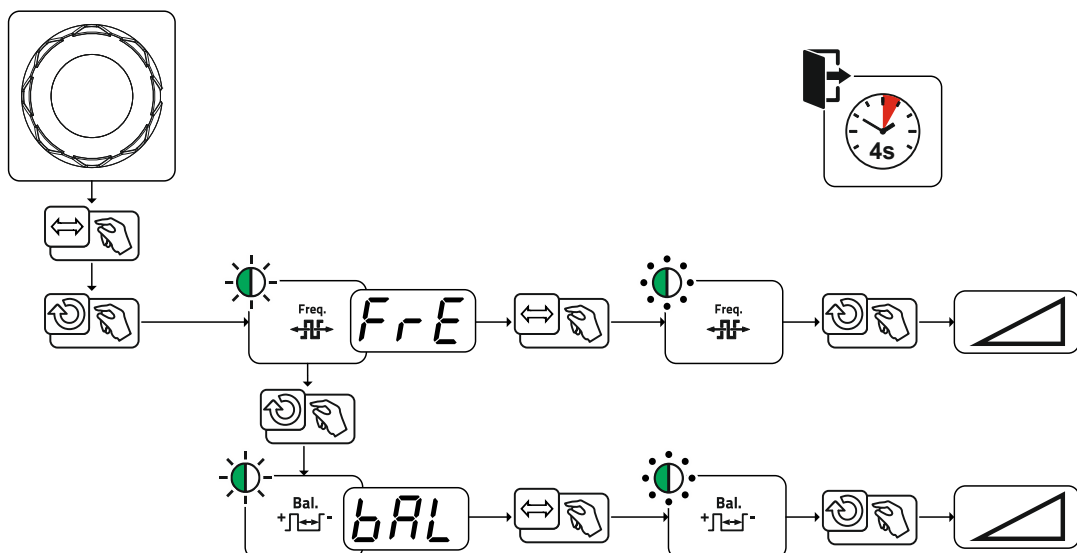

Figure 5-24

## 5.2.9.1 Thermal pulsing

The operation sequences basically match the standard welding sequences, but there is an additional switching back and forth between the main current AMP (pulse current) and the secondary current AMP% (pulse pause current) at the set times. Pulse and pause times and the pulse edges ( $\overline{E51}$  and  $\overline{E52}$ ) are entered in seconds on the control.

The  $\overline{E51}$  and  $\overline{E52}$  pulse edges can be set in the Expert menu (TIG) > see 5.2.12 chapter.

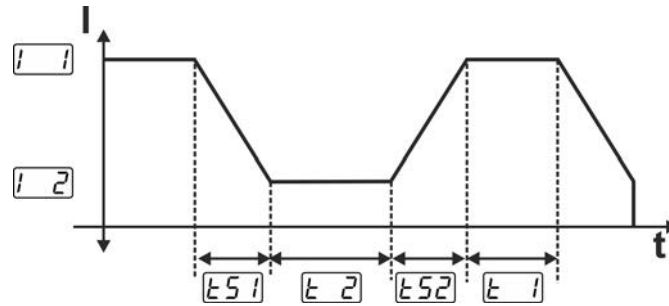

Figure 5-25

### Setting the pulse and pulse pause time

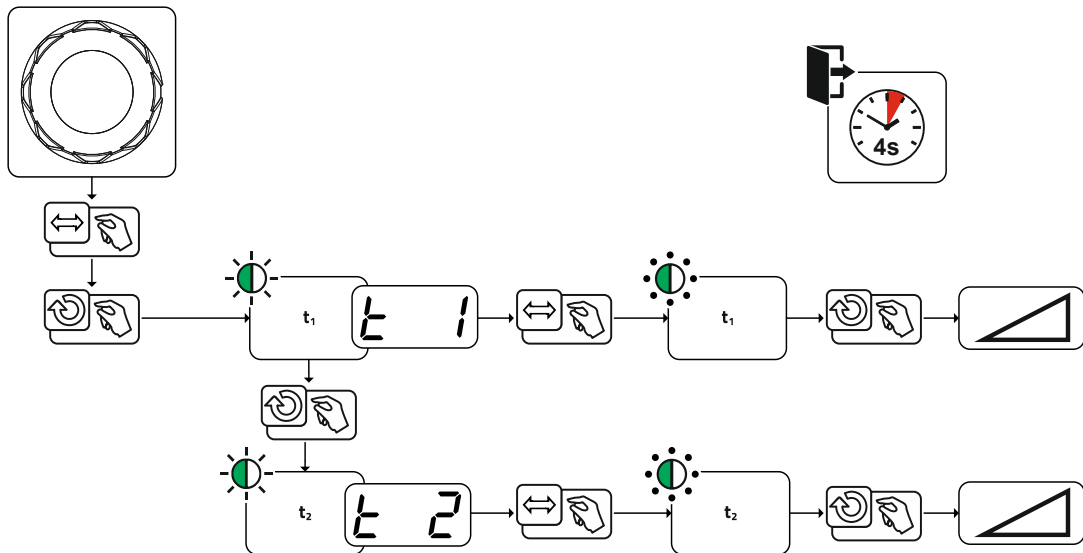

Figure 5-26

## 5.2.9.2 Automated pulses

The automated pulsing pulse variant is only activated for DC welding in combination with the spotArc operating mode. The current-dependent pulse frequency and balance create vibrations in the weld pool that have a positive effect on the gap bridging. The required pulse parameters are automatically defined by the machine control. If required, the function can be disabled by pressing the pulsed welding push-button.

### 5.2.9.3 AC special

Is e.g. used to join metal sheets of different thickness.

#### Pulse time setting

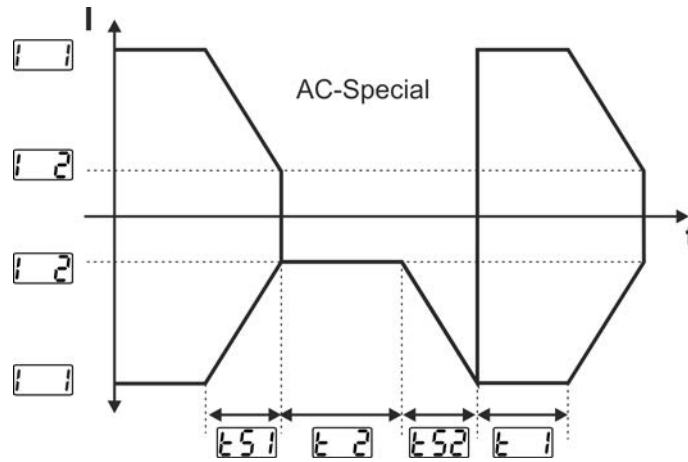

Figure 5-27

The  $E51$  and  $E52$  pulse edges can be set in the Expert menu (TIG) > see 5.2.12 chapter.

### 5.2.9.4 Pulsed welding in the upslope and downslope phases

The pulse function can also be deactivated if necessary during the up-slope and down-slope phases (parameter  $PSL$ ) > see 5.11 chapter.

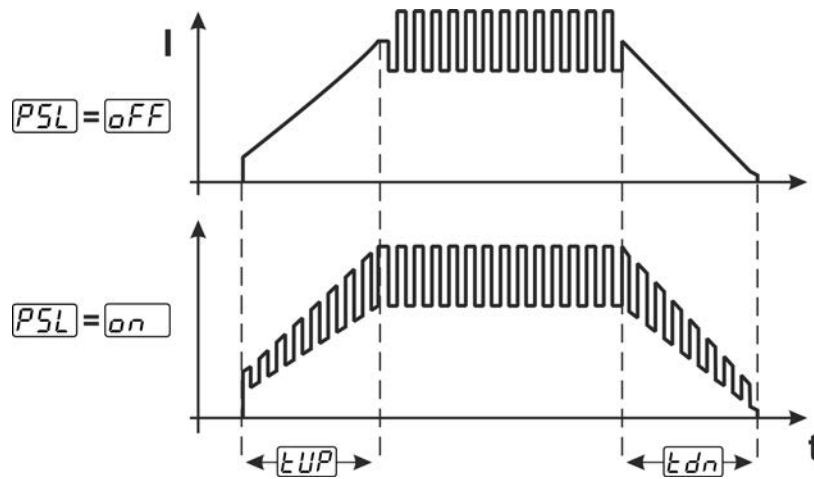

Figure 5-28

## 5.2.10 Welding torch (operating variants)

### 5.2.10.1 Welding torch mode

The operating elements (torch triggers or rockers) and their function can be individually adapted using various torch modes. Up to six modes are available to the user. The tables for the corresponding torch types describe the functional options.

**Explanation of symbols for welding torch:**

Symbol	Description
	Press torch trigger
	Tap torch trigger
	Tap torch trigger and then press
<b>BRT 1, 2</b>	Torch trigger 1 or 2
<b>UP</b>	Torch trigger UP - increase the value
<b>DOWN</b>	Torch trigger DOWN - decrease the value

The torch modes are set using the torch configuration parameters "trd" in the machine configuration menu > torch mode "trd" > see 5.11 chapter.

**Only the modes listed are suitable for the corresponding torch types.**

#### Welding torch with one torch trigger

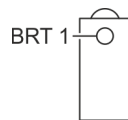

Figure 5-29

Function	Operation	Mode
Welding current On / Off	BRT 1	1
Secondary current (in latched operation)		

#### Welding torch with two torch triggers or rocker

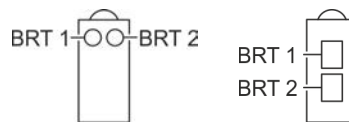

Figure 5-30

Function	Operation	Mode
Welding current On / Off	BRT 1	1
Secondary current	BRT 2	
Secondary current (in latched operation)	BRT 1	
Welding current On / Off	BRT 1	3
Increase welding current (up/down speed)	BRT 2	
Decrease welding current (up/down speed)	BRT 2	
Secondary current (in latched operation)	BRT 1	

## Welding torch with one torch trigger and up/down push-buttons

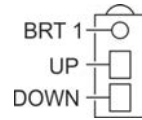

Figure 5-31

Function	Operation	Mode	
Welding current On / Off	BRT 1	↓	1
Secondary current (in latched operation)			
Increase welding current (up/down speed)	UP	↓	
Decrease welding current (up/down speed)	DOWN	↓	
Welding current On / Off	BRT 1	↓	4
Secondary current (in latched operation)			
Increase welding current in steps (current jump)	UP	↓	
Decrease welding current in steps (current jump)	DOWN	↓	

## Welding torch with two torch triggers and up/down push-buttons

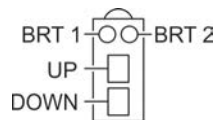

Figure 5-32

Function	Operation	Mode	
Welding current On / Off	BRT 1	↓	1
Secondary current (in latched operation)			
Secondary current	BRT 2	↓	
Increase welding current (up/down speed)	UP	↓	
Decrease welding current (up/down speed)	DOWN	↓	
Welding current On / Off	BRT 1	↓	4
Secondary current (in latched operation)			
Secondary current	BRT 2	↓	
Increase welding current in steps (current jump)	UP	↓	
Decrease welding current in steps (current jump)	DOWN	↓	
Gas test	BRT 2	↓ 3 s	

## TIG function torch, Retox XQ

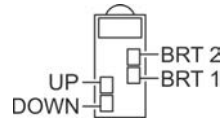

Figure 5-33

Function	Operation		Mode
Welding current On / Off	BRT 1	↓	1
Secondary current (in latched operation)		↕	
Secondary current	BRT 2	↓	
Increase welding current (up/down speed)	UP	↓	
Decrease welding current (up/down speed)	DOWN	↓	
Welding current On / Off	BRT 1	↓	
Secondary current (in latched operation)		↕	
Secondary current	BRT 2	↓	
Increase welding current in steps (current jump)	UP	↓	
Decrease welding current in steps (current jump)	DOWN	↓	
Switching between current jump and JOB	BRT 2	↕	
Increase JOB number	UP	↓	
Decrease JOB number	DOWN	↓	
Gas test	BRT 2	↓ 3 s	
Welding current On / Off	BRT 1	↓	5
Secondary current (in latched operation)		↕	
Secondary current	BRT 2	↓	
Increase program number	UP	↓	
Decrease program number	DOWN	↓	
Switching between program and JOB	BRT 2	↕	
Increase JOB number	UP	↓	
Decrease JOB number	DOWN	↓	
Gas test	BRT 2	↓ 3 s	

Function	Operation		Mode
Welding current On / Off	BRT 1	↓	6
Secondary current (in latched operation)		↕	
Secondary current	BRT 2	↓	
Infinitely variable increase of welding current (up/down speed)	UP	↓	
Infinitely variable decrease of welding current (up/down speed)	DOWN	↓	
Switching between up/down speed and JOB number	BRT 2	↕	
Increase JOB number	UP	↓	
Decrease JOB number	DOWN	↓	
Gas test	BRT 2	↓ 3 s	

### 5.2.10.2 Tapping function (tap torch trigger)

Tapping function: Swiftly tap the torch trigger to change the function. The set torch mode determines the operating mode.

The tapping function can be selected separately for each torch mode for the start of welding with parameter  $\overline{EPE}$  and for the end of welding with parameter  $\overline{EPE}$ . If parameter  $\overline{EPE}$  is activated, there is no need to tap the secondary current.

### 5.2.10.3 Up/down speed

#### Functionality

Press and hold the up push-button:

Increase current up to the maximum value (main current) set in the power source.

Press and hold the down push-button:

Decrease current to the minimum value.

Use the machine configuration menu > see 5.11 chapter to set the up/down speed parameter  $\overline{Ud}$  which determines the speed with which a current change becomes effective.

### 5.2.10.4 Current jump

By tapping the corresponding torch trigger the welding current can be determined in an adjustable jump range. Each tap will cause the welding current to jump up or down by the defined value.

The "current jump" parameter  $\overline{d}$  is set in the machine configuration menu > see 5.11 chapter.

## 5.2.11 RTF 1 foot-operated remote control

### 5.2.11.1 RTF start ramp

The RTF start ramp function prevents the energy input at the start of welding from being too high and too fast should the user press the remote control pedal too fast and too strongly.

Example:

The user sets the main current at the welding machine to 200 A. The user presses the remote control pedal very quickly down by approx. 50% of the pedal travel.

- RTF start ramp switched on: The welding current increases in a linear (slow) ramp to approx. 100 A.
- RTF start ramp switched off: The welding current immediately jumps to approx. 100 A.

The RTF start ramp function is activated/deactivated by the parameter  $\overline{FFr}$  in the machine configuration menu > see 5.11 chapter.

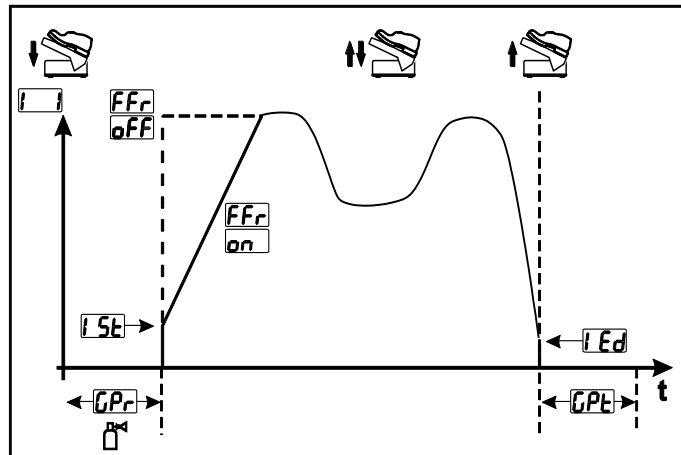

Figure 5-34

Display	Setting/selection
$\overline{FFr}$	<b>RTF start ramp &gt; see 5.2.11.1 chapter</b> $\overline{on}$ ----- Welding current rises to the specified main current level in a ramp function (ex works) $\overline{off}$ ----- Welding current immediately jumps to the specified main current level
$\overline{GPr}$	<b>Gas pre-flow time</b>
$\overline{ISt}$	<b>Ignition current (as percentage, dependent on main current)</b>
$\overline{IEd}$	<b>End-crater current</b> Setting range in percent: depending on main current Setting range, absolute: Imin to Imax.
$\overline{GPt}$	<b>Gas post-flow time</b>



## 5.2.11.2 RTF response

This function controls the current response during the main current phase. The user can choose between linear and logarithmic response. The logarithmic setting is especially suited for welding with low currents, e.g. for thin panels, as the logarithmic response enables a better control of the welding current.

In the machine configuration menu, the RTF response function  $\overline{FrE}$  can be toggled between linear response  $\overline{Lin}$  and logarithmic response  $\overline{LoG}$  (ex works) > see 5.11 chapter.

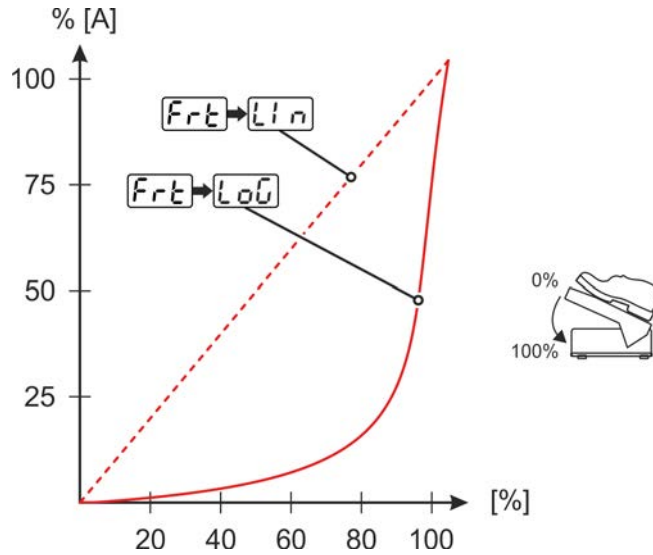

Figure 5-35

## 5.2.12 Expert menu (TIG)

The Expert menu has adjustable parameters stored that don't require regular setting. The number of parameters shown may be limited, e.g. if a function is deactivated.

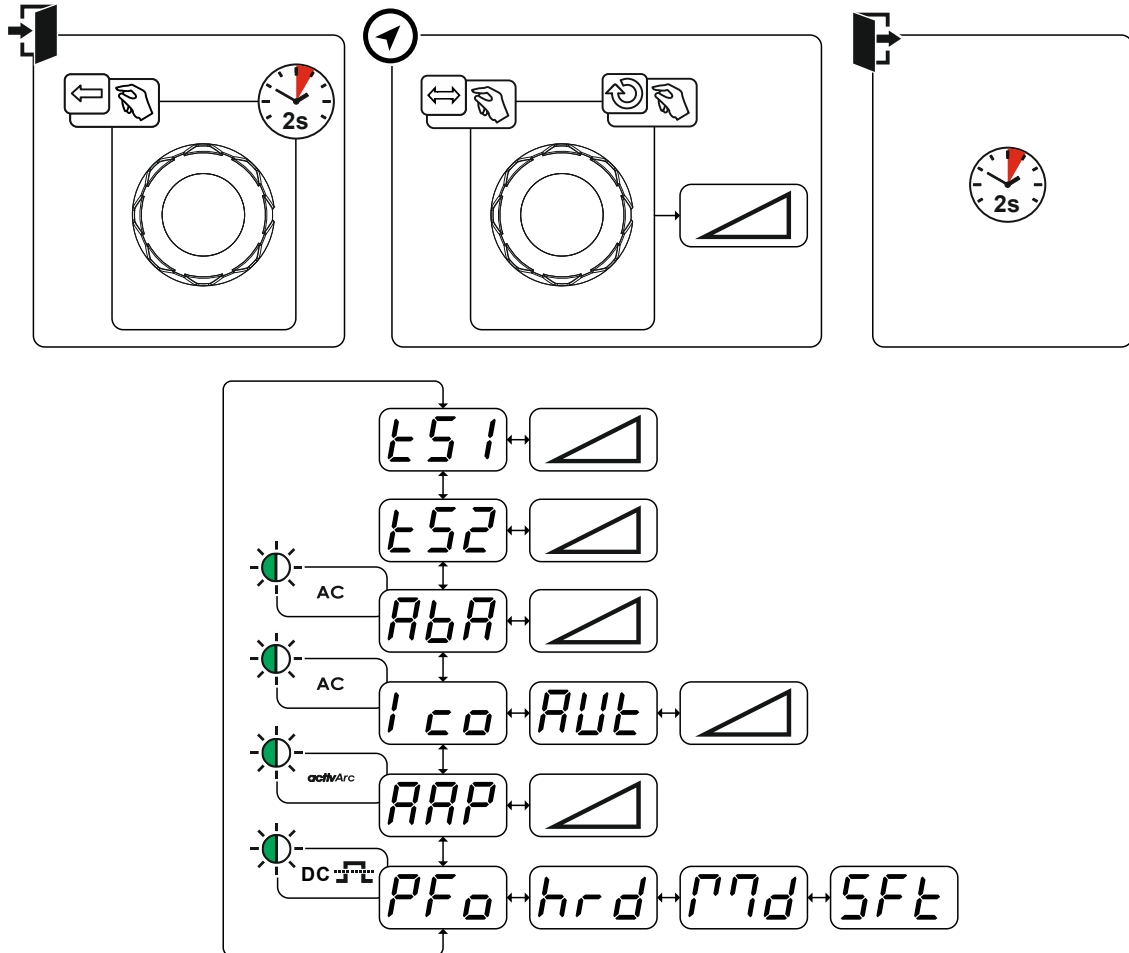

Figure 5-36

Display	Setting/selection
t51	Slope time (main current to secondary current)
t52	Slope time (secondary current to main current)
AbA	Amplitude balance > see 5.2.3.4 chapter
Ico	AC commutation optimisation > see 5.2.3.6 chapter
AAP	Parameter activArc > see 5.2.6 chapter Setting the intensity
PF0	<b>Pulse shape</b> hrd----- hard rectangular current curve and high arc force that however generates a louder arc noise (factory setting) r7d----- rectangular current curve with rounded edges and low noise. For universal welding tasks 5Ft----- heavily rounded current curve, lower arc force and low arc noise

## 5.2.13 Aligning the cable resistance

To ensure optimum welding properties, the electric cable resistance should be aligned again whenever an accessory component such as the welding torch or the intermediate hose package (AW) has been changed. The resistance value of the cables can be set directly or can be aligned by the power source. In the delivery state the cable resistance is set to the optimum values. To optimise the welding properties for other cable lengths, an alignment process (voltage correction) is necessary.

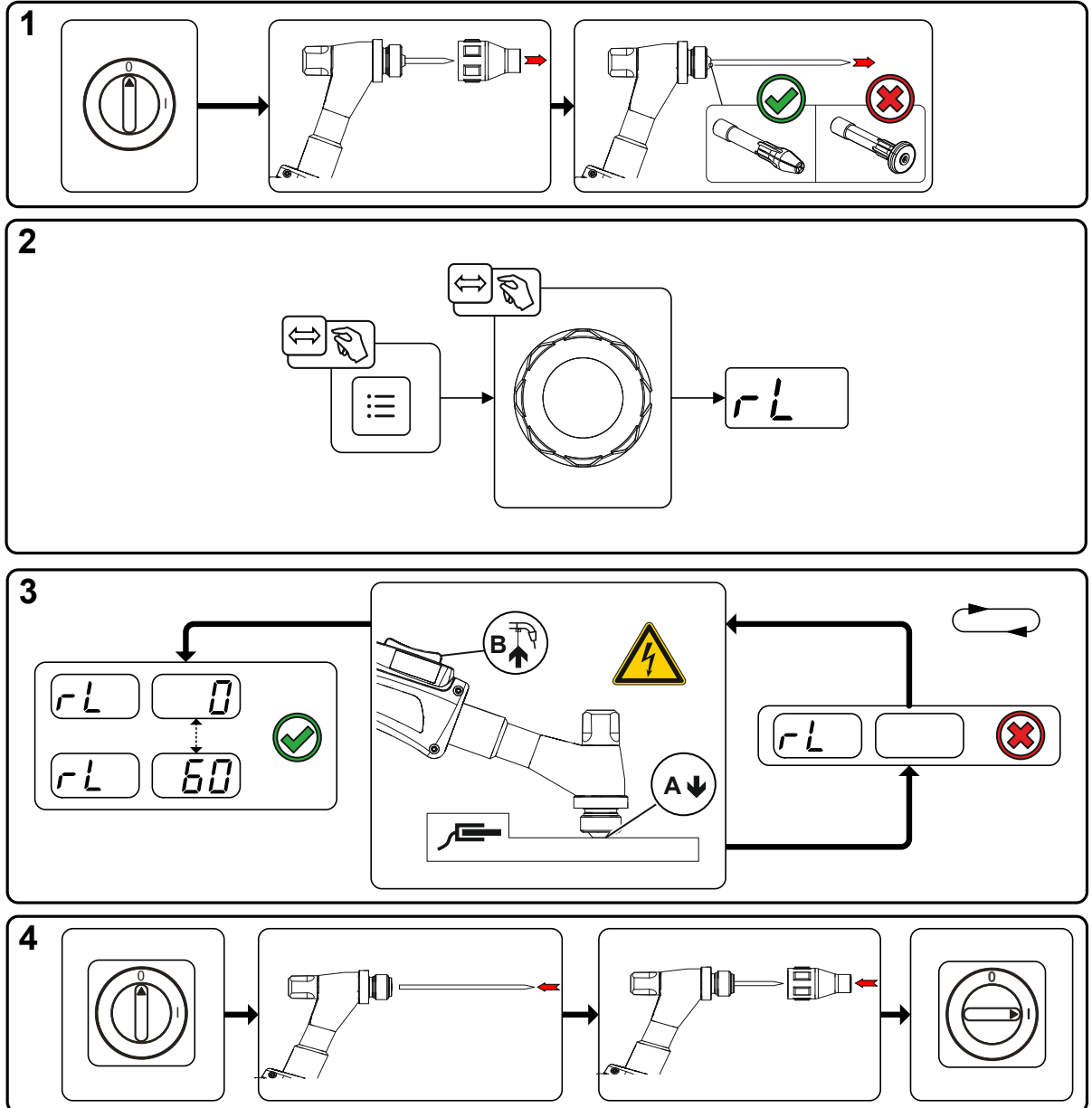



Figure 5-37

## 1 Preparation

- Switch off the welding machine.
- Unscrew the gas nozzle from the welding torch.
- Unfasten the tungsten electrode and extract.
- Switch on the welding machine.

## 2 Configuration

- Press push-button .
- Press the rotary button and select parameter .

## 3 Alignment / Measurement

- Applying slight pressure, press the welding torch with the collet against a clean, purged location on the workpiece and then press the torch trigger for approx. 2 seconds. A short-circuit current will flow briefly, which is used to determine and display the cable resistance. The value can be between 0 mΩ and 60 mΩ. The new value is immediately saved without requiring further confirmation. If no value is shown on the right-hand display, then measurement failed. The measurement must be repeated.

## 4 Restoring welding standby mode

- Switch off the welding machine.
- Lock the tungsten electrode in the collet again.
- Screw the gas nozzle onto the welding torch.
- Switch on the welding machine.

## 5.3 MMA welding

### 5.3.1 Welding task selection

It is only possible to change the basic parameters when no welding current is flowing and any possible access control is disabled > see 5.8 chapter.

The following welding task selection is an example of use. In general, the selection process always has the same sequence. Signal lights (LED) will show the selected combination.

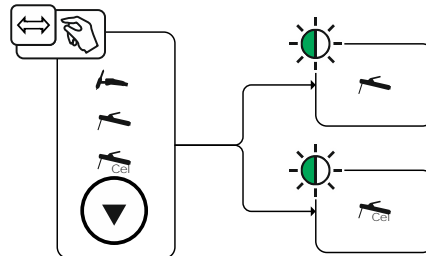

Figure 5-38

### 5.3.2 Hotstart

The function hot start ensures a secure igniting of the arc and a sufficient heating to the still cold parent metal at the beginning of the welding process. The ignition takes place here with increased current (hot start current) over a certain time (hot start time).

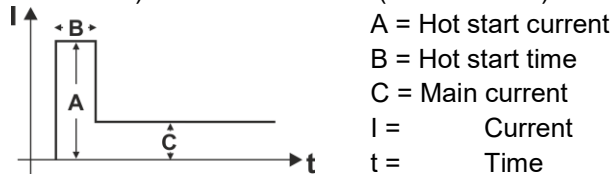

Figure 5-39

#### 5.3.2.1 Selection and adjustment

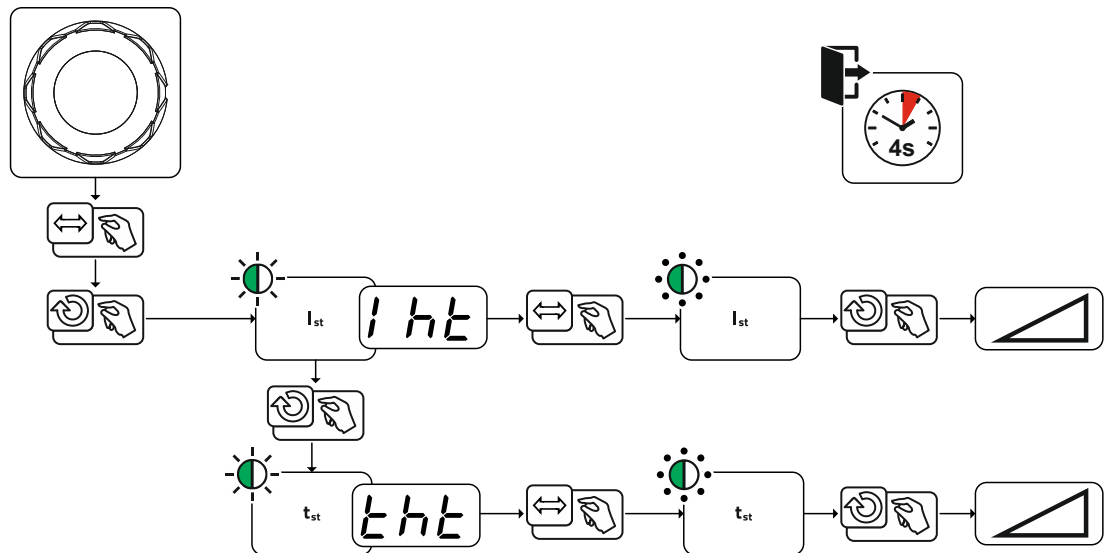

Figure 5-40

### 5.3.3 Arcforce

During the welding process, arcforce prevents the electrode sticking in the weld pool with increases in current. This makes it easier to weld large-drop melting electrode types at low current strengths with a short arc in particular.

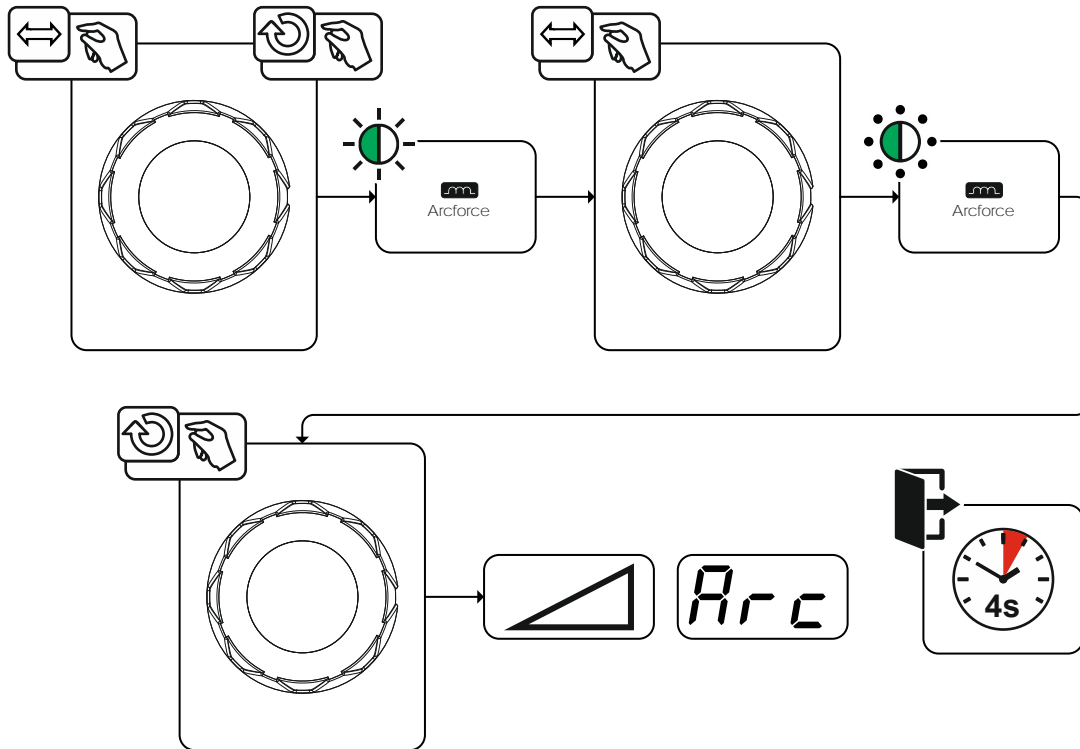
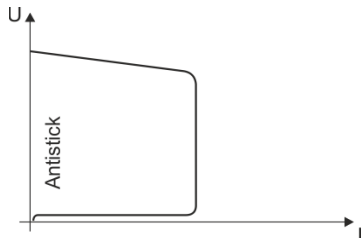

Figure 5-41

### 5.3.4 Antistick



**The Antistick feature prevents the electrode from annealing.**

Should the electrode stick despite the Arcforce feature, the machine automatically switches to the minimum current within approx. one second. This prevents the electrode from annealing. Check the welding current setting and correct for the welding task in hand.

Figure 5-42

### 5.3.5 Welding current polarity reversal (polarity reversal)

This function can be used to reverse the welding current polarity electronically.

For example, when welding with different electrode types for which different polarities are stipulated by the manufacturer, the welding current polarity can be switched easily on the control.

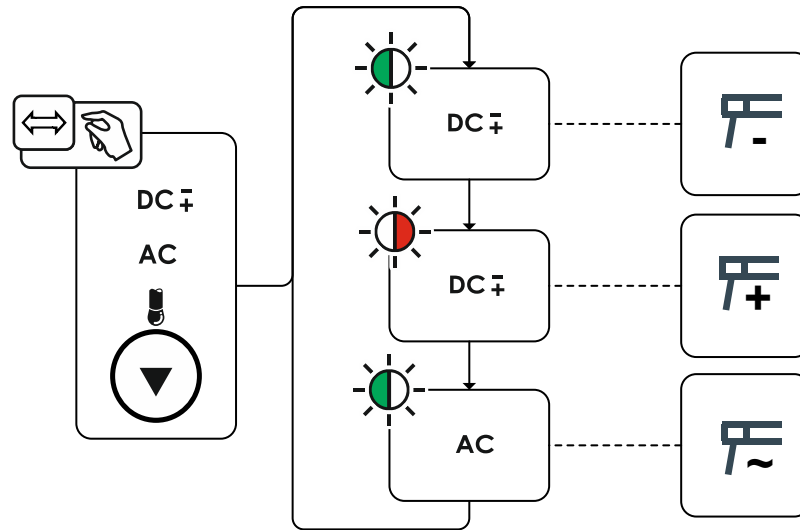

Figure 5-43

### 5.3.6 AC welding

#### 5.3.6.1 Automatic AC frequency

Activation takes place in the functional sequence using the parameter frequency  $f_{\text{freq}}$ . By turning to the left, the parameter value is reduced until the parameter  $f_{\text{aut}}$  (AC frequency automatic) is shown in the display. The signal light  $f_{\text{aut}}$  comes on when the function is enabled.

The machine control takes over the regulation or setting of the alternating current frequency depending on the set main current. The lower the welding current, the higher the frequency and vice versa. This achieves a concentrated, directionally stable arc when welding currents are low. The load on the tungsten electrode is minimised when the welding currents are high ensuring a longer service life.

The use of a foot-operated remote control with this function reduces manual intervention by the user during the welding process to a minimum.

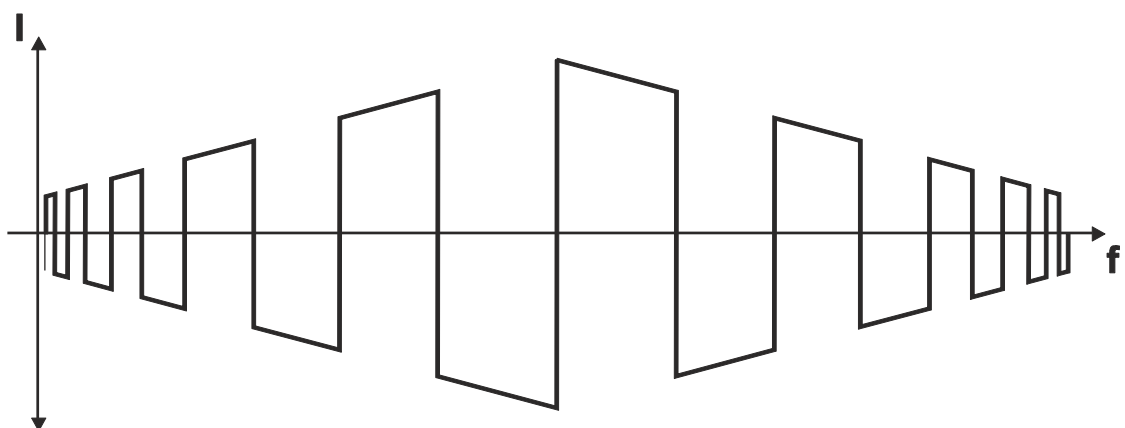

Figure 5-44

## Selection

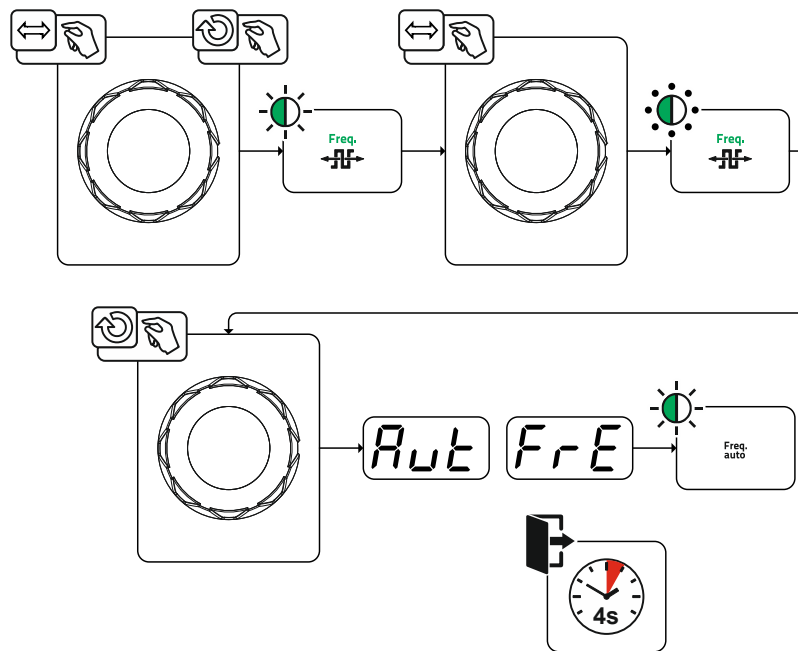

Figure 5-45

## 5.3.7 Pulse welding

### 5.3.7.1 Average value pulse welding

Average value pulse welding means that two currents are switched periodically, a current average value (AMP), a pulse current (Ipuls), a balance ( $\overline{bRL}$ ) and a frequency ( $\overline{FrE}$ ) having been defined first. The predefined ampere current average value is decisive, the pulse current (Ipuls) is defined by the  $\overline{IPL}$  parameter as a percentage of the current average value (AMP). The pulse pause current (IPP) requires no setting. This value is calculated by the machine control, so that the welding current average value (AMP) is maintained at all times.

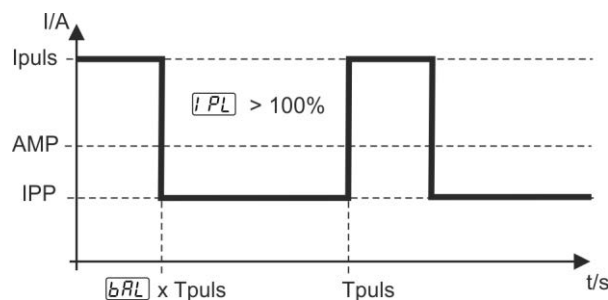

Figure 5-46

AMP = Main current; e.g. 100 A

Ipuls = Pulse current =  $\overline{IPL}$  x AMP; e.g. 140% x 100 A = 140 A

IPP = Pulse pause current

Tpuls = Duration of one pulse cycle =  $1/\overline{FrE}$ ; e.g. 1/1 Hz = 1 s

$\overline{bRL}$  = Balance

## 5.4 Arc length restriction (USP)

The arc length restriction  $\overline{USP}$  function stops the welding process when an excessive arc voltage is detected (unusually large gap between electrode and workpiece). The function can be switched on or off depending on the process > see 5.11 chapter.



## 5.5 JOB favourites

Favourites are additional locations for storing and loading frequently used welding tasks, programs and their settings. The status of the Favourites (loaded, changed, not loaded) is indicated by signal lights.

- Five Favourites are available to save any settings.
- As required, the access control can be adjusted with the key switch or Xbutton function.

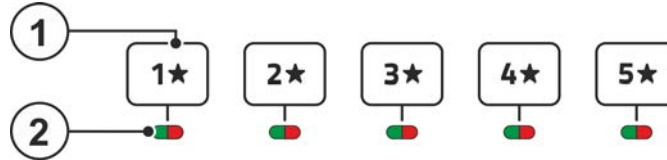

Figure 5-47

Item	Symbol	Description
1		<b>push-button - JOB Favourites</b> <ul style="list-style-type: none"> <li>•-----Pressing the push-button briefly: Loading Favourites</li> <li>•-----Press and hold the push-button (&gt;2 s): Saving as a Favourite</li> <li>•-----Press and hold the push-button (&gt;12 s): Deleting a Favourite</li> </ul>
2		<b>Signal light of Favourite status</b> <ul style="list-style-type: none"> <li>-----Signal light is green: Favourite loaded, settings of the Favourite and the current device settings are identical</li> <li>-----Signal light is red: Favourite loaded, but settings of the Favourite and the current device settings are not identical (for example, the operating point has been changed)</li> <li>-----Signal light is off: Favourite not loaded (e.g. JOB number has been changed)</li> </ul>

### 5.5.1 Saving current settings to Favourites

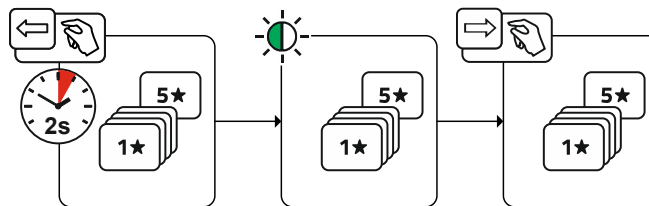

Figure 5-48

- Press and hold the favourite memory push-button for 2 s (the signal light of the favourite status is green).

### 5.5.2 Loading saved Favourites

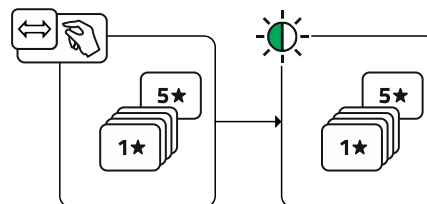

Figure 5-49

- Press the favourite memory push-button (the signal light of the favourite status is green).

## 5.5.3 Deleting saved Favourites

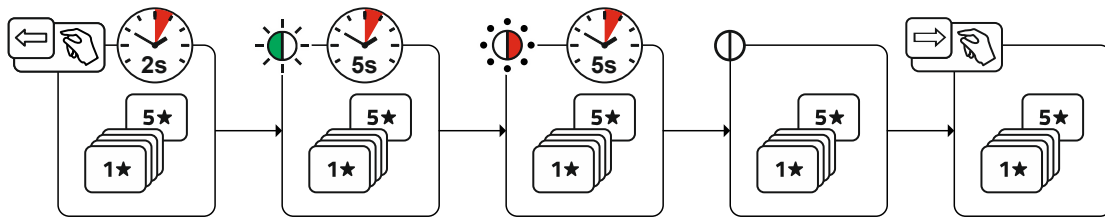

Figure 5-50

- Press and hold the favourite memory push-button.  
After 2 seconds, the signal light of the favourite status turns green  
after another 5 s, the signal light starts flashing red  
after another 5 s the signal light goes out
- Release the favourite memory push-button.

## 5.6 Managing welding tasks (JOB manager)

### 5.6.1 Copying welding tasks (JOB)

Use this function to copy the JOB data of the currently selected JOB to a target -JOB to be specified.

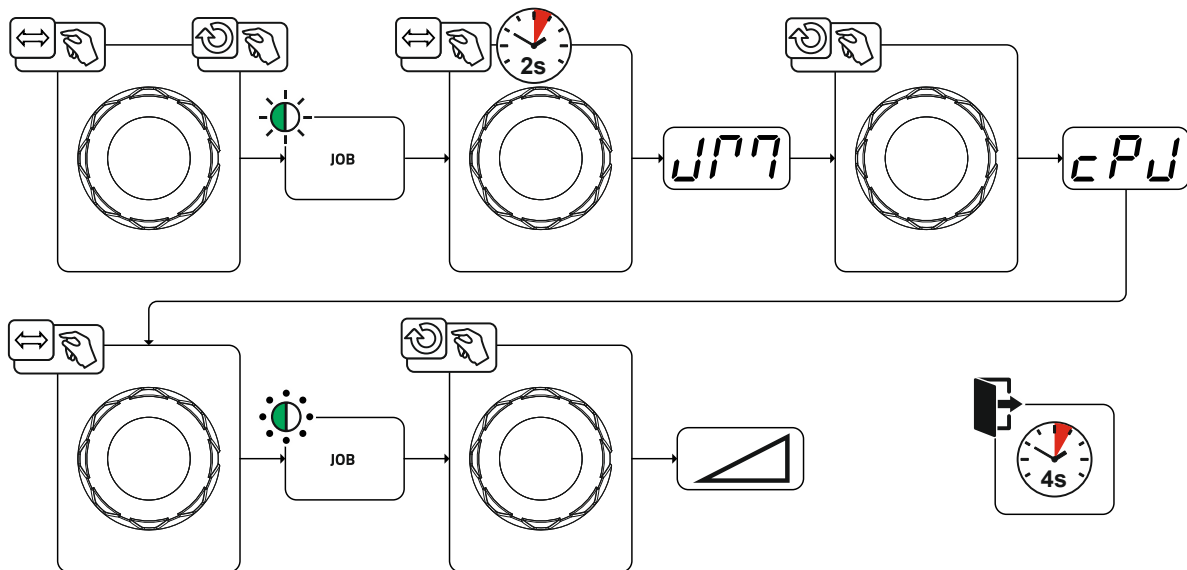

Figure 5-51

### 5.6.2 Reset welding task (JOB) to the factory setting

This function resets the JOB data of a welding task (JOB) to be selected to the factory settings.

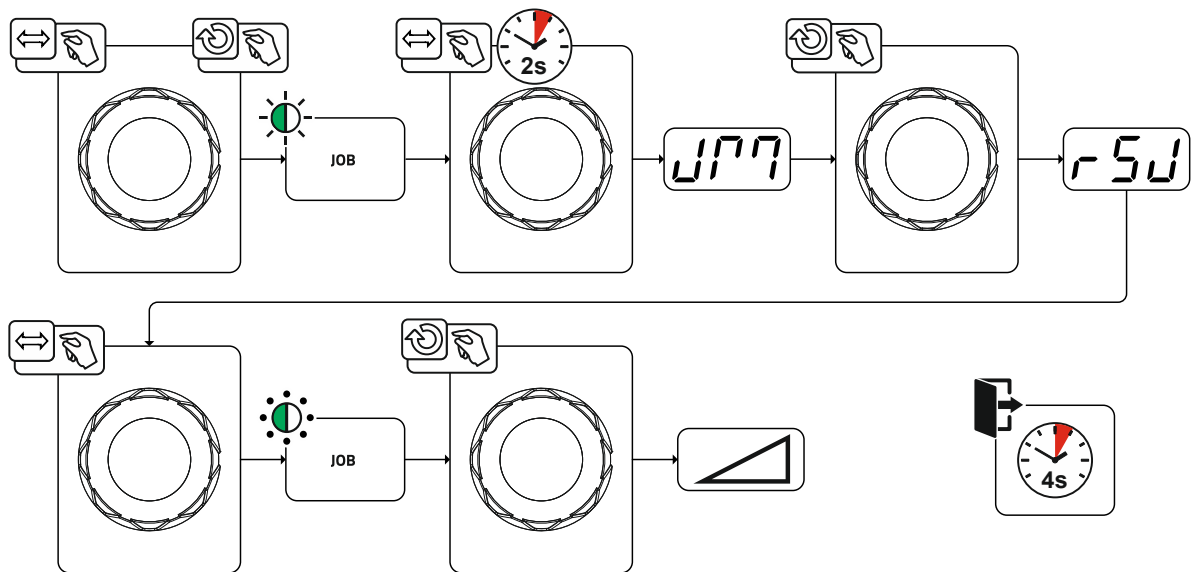
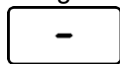

Figure 5-52

### 5.7 Power-saving mode (Standby)

You can activate the power-saving mode by either pressing the push-button > see 4 chapter for a prolonged time or by setting a parameter in the machine configuration menu (time-controlled power-saving mode **[5bR]**) > see 5.11 chapter.



When power-saving mode is activated, the machine displays show the horizontal digit in the centre of the display only.

Pressing any operating element (e.g. turning a rotary knob) deactivates power-saving mode and the machine is ready for welding again.

### 5.8 Access control

The machine control can be locked to secure it against unauthorised or unintentional adjustment. The access block has the following effect:

- The parameters and their settings in the machine configuration menu, Expert menu and operation sequence can only be viewed but not changed.
- Welding procedure and welding current polarity cannot be changed.

The parameters for setting the access block are configured in the machine configuration menu > see 5.11 chapter.

#### Enabling access block

- Assign the access code for the access block: Select parameter **[cod]** and select a number code (0–999).
- Enable access block: Set parameter **[Loc]** to access block enabled **[on]**.

The access block activation is indicated by the "Access block active" signal light > see 4 chapter.

#### Disabling access block

- Enter the access code for the access block: Select parameter **[cod]** and enter the previously selected number code (0–999).
- Disable access block: Set parameter **[Loc]** to access block disabled **[off]**. The only way to disable the access block is to enter the selected number code.

## 5.9 Voltage reducing device

The voltage reduction device (VRD) is used to increase safety, especially in dangerous environments (such as shipbuilding, pipeline construction, mining).

The use of a voltage reduction device is mandatory in some countries and specified in many in-house safety regulations for welding power sources.

The VRD > see 4.1.2 chapter signal light lights up when the voltage reducing device is working properly and the output voltage has been reduced to the values specified in the relevant standard (technical data).

## 5.10 Dynamic power adjustment

**This requires use of the appropriate mains fuse.**

**Observe mains fuse specification!**

This function enables aligning the machine to the mains connection fusing. This may counteract frequent tripping of the mains fuse. The maximum input power of the machine is limited with an exemplary value for the existing mains fuse (infinitely variable).

You can predefine this value in the machine configuration menu > see 5.11 chapter using parameter `FUS`.

The function automatically adjusts the welding power to an uncritical level for the corresponding mains fuse.



***When using a 25-A mains fuse, a suitable mains plug has to be installed by a qualified electrician.***

## 5.11 Machine configuration menu

Basic machine settings are defined in the machine configuration menu.

### 5.11.1 Selecting, changing and saving parameters

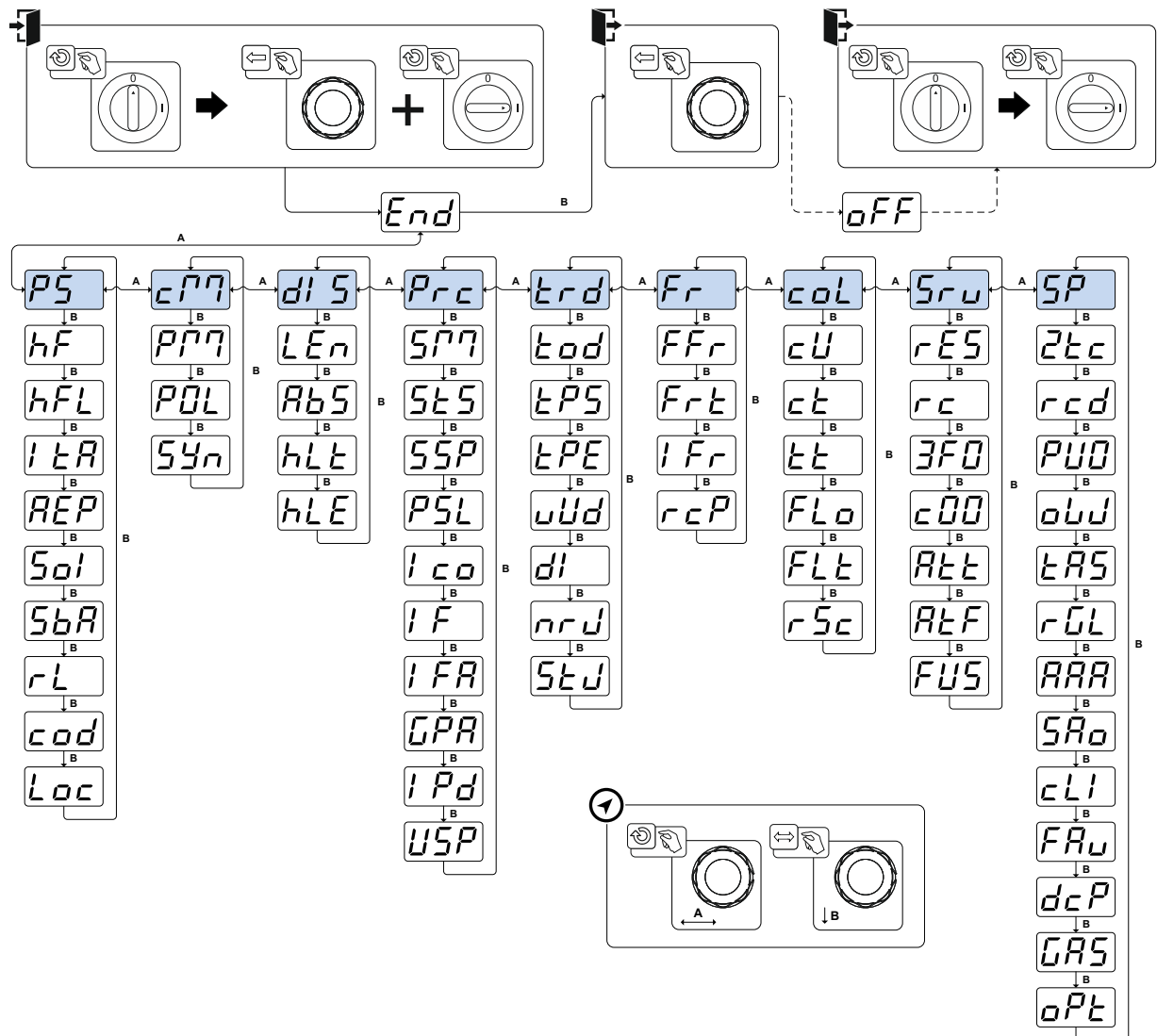

Figure 5-53

Display	Setting/selection
<b>End</b>	<b>Exit the menu</b> Exit
<b>off</b>	<b>Switching the machine off and on</b> Required for applying various configuration parameters
<b>PS</b>	<b>Power source menu</b>
<b>HF</b>	<b>Switch ignition mode</b> on -----HF ignition off -----Liftarc
<b>HFL</b>	<b>HF intensity</b> Std -----Standard setting (factory setting) rEd -----Reduced HF intensity
<b>lEtA</b>	<b>Re-ignition after arc interruption &gt; see 5.2.4.3 chapter</b> Job -----JOB-dependent time (ex works 5 s). off -----Function disabled or numerical value 0.1–5.0 s.

Display	Setting/selection
<b>REP</b>	<b>Reconditioning pulse (tungsten ball stability) <sup>1</sup></b> Cleaning effect of the tungsten ball at the end of welding. <input type="checkbox"/> ----- Function enabled (ex works) <input type="checkbox"/> ----- Function disabled
<b>SoI</b>	<b>TIG HF start (soft/hard) switching</b> <input type="checkbox"/> ----- soft ignition (factory setting). <input type="checkbox"/> ----- hard ignition.
<b>SbA</b>	<b>Time-based power-saving mode &gt; see 5.7 chapter</b> Time to activation of the power-saving mode in case of inactivity. Setting <input type="checkbox"/> = disabled or numerical value 5-60 min..
<b>rL</b>	<b>Cable resistance alignment &gt; see 5.2.13 chapter</b>
<b>cod</b>	<b>Access control – access code</b> Setting: 000 to 999 (000 ex works)
<b>Loc</b>	<b>Access control &gt; see 5.8 chapter</b> <input type="checkbox"/> ----- Function enabled <input type="checkbox"/> ----- Function disabled (ex works)
<b>cPn</b>	<b>Operating mode menu</b>
<b>pPn</b>	<b>Program mode</b> <input type="checkbox"/> ----- Function disabled (factory setting) <input type="checkbox"/> ----- Function enabled
<b>POL</b>	<b>Program lock (P0)</b> The program P0 is locked when locking with the key switch. It is only possible to switch between programs P1 to P15. <input type="checkbox"/> ----- Function disabled (factory setting) <input type="checkbox"/> ----- Function enabled
<b>Syn</b>	<b>Operating principle</b> <input type="checkbox"/> ----- synergic parameter setting (factory setting) <input type="checkbox"/> ----- conventional parameter setting
<b>dI S</b>	<b>Machine display menu</b>
<b>LEn</b>	<b>Setting the system of units</b> <input type="checkbox"/> ----- Units of length in mm, m/min. (metric system) <input type="checkbox"/> ----- Unit of length in inches, ipm (imperial system)
<b>AbS</b>	<b>Absolute value setting (ignition, secondary, end and hot start current) &gt; see 4.3.2 chapter</b> <input type="checkbox"/> ----- Welding current setting, absolute <input type="checkbox"/> ----- Welding current setting, as a percentage of the main current (ex works)
<b>HLt</b>	<b>Hold value TIG</b> <input type="checkbox"/> ----- Hold value is displayed until activated by rotary transducer or welding start (factory setting) <input type="checkbox"/> ----- Hold value is only displayed for a defined time <input type="checkbox"/> ----- Function disabled
<b>HLt</b>	<b>Hold value MMA</b> <input type="checkbox"/> ----- Hold value is only displayed for a defined time (factory setting) <input type="checkbox"/> ----- Function disabled
<b>Prc</b>	<b>Process menu</b>

Display	Setting/selection
577	<b>spotmatic operating mode &gt; see 5.2.5.5 chapter</b> Ignition by contact with the workpiece <input type="checkbox"/> -----Function enabled (ex works) <input type="checkbox"/> -----Function disabled
5t5	<b>Spot time setting &gt; see 5.2.5.5 chapter</b> <input type="checkbox"/> -----Short spot time, setting range 5 ms to 999 ms, increments of 1 ms (ex works) <input type="checkbox"/> -----Long spot time, setting range 0.01 s to 20.0 s, increments of 10 ms (ex works)
5SP	<b>Process activation setting &gt; see 5.2.5.5 chapter</b> <input type="checkbox"/> -----Separate process activation (ex works) <input type="checkbox"/> -----Permanent process activation
PSL	<b>Pulsed TIG welding (thermic) in the upslope and downslope phases &gt; see 5.2.9.4 chapter</b> <input type="checkbox"/> -----Function enabled (ex works) <input type="checkbox"/> -----Function disabled
1co	<b>AC commutation optimisation &gt; see 5.2.3.6 chapter<sup>1</sup></b> <input type="checkbox"/> -----Function enabled <input type="checkbox"/> -----Function disabled (ex works)
1F	<b>AC waveform</b> <input type="checkbox"/> -----Manual setting of the waveform (factory setting) <input type="checkbox"/> -----Synergy to current (only usable with x-connect)
1FA	<b>AC waveform - advanced</b> <input type="checkbox"/> -----Function disabled (factory setting) <input type="checkbox"/> -----Function enabled
GPA	<b>Automatic gas post-flow function &gt; see 5.1.1.1 chapter</b> <input type="checkbox"/> -----Function on <input type="checkbox"/> -----Function off (factory setting)
1Pd	<b>Ignition pulse dynamics</b> <input type="checkbox"/> -----Function enabled (factory setting) <input type="checkbox"/> -----Function disabled
USP	<b>Arc length restriction &gt; see 5.4 chapter</b> <input type="checkbox"/> -----Function switched on <input type="checkbox"/> -----Function switched off
trd	<b>Torch configuration menu</b> Set welding torch functions
tod	<b>Torch mode (ex works 1) &gt; see 5.2.10.1 chapter</b>
EPS	<b>Alternative welding start – tapping start</b> Available from torch mode 11 (welding stop by tapping remains active). <input type="checkbox"/> -----Function enabled (ex works) <input type="checkbox"/> -----Function disabled
EPF	<b>Tap end &gt; see 5.2.10.2 chapter</b> <input type="checkbox"/> -----Function enabled <input type="checkbox"/> -----Function disabled (factory setting)
udd	<b>Up/down speed &gt; see 5.2.10.3 chapter</b> Increase value > rapid current change Decrease value > slow current change
dl	<b>Current jump &gt; see 5.2.10.4 chapter</b> Current jump setting in ampere
nrU	<b>Get JOB number</b> Set maximum selectable JOBS for function torch Retox XQ (setting: 1 to 100, factory setting 10).

Display	Setting/selection
<b>StU</b>	<b>Start JOB</b> Set first retrievable JOB (setting: 1 to 100, factory setting 1).
<b>Fr</b>	<b>Remote control menu</b>
<b>FFr</b>	<b>RTF start ramp &gt; see 5.2.11.1 chapter</b> <input type="checkbox"/> <b>on</b> ----- Welding current rises to the specified main current level in a ramp function (ex works) <input type="checkbox"/> <b>oFF</b> ----- Welding current immediately jumps to the specified main current level
<b>FrL</b>	<b>RTF response &gt; see 5.2.11.2 chapter</b> <input type="checkbox"/> <b>Lin</b> ----- Linear response <input type="checkbox"/> <b>LoU</b> ----- Logarithmic responsive (ex works)
<b>IFr</b>	<b>RTF-Minimum current setting (AC)</b>
<b>rCP</b>	<b>Welding current polarity switching <sup>1</sup></b> <input type="checkbox"/> <b>on</b> ----- polarity switching at the RT PWS 1 19POL remote control (ex works) <input type="checkbox"/> <b>oFF</b> ----- polarity switching at the welding machine control
<b>coL</b>	<b>Torch cooling menu</b>
<b>cu</b>	<b>Torch cooling mode</b> <input type="checkbox"/> <b>Aut</b> ----- Automatic operation (ex works) <input type="checkbox"/> <b>on</b> ----- Permanently enabled <input type="checkbox"/> <b>oFF</b> ----- Permanently disabled
<b>ct</b>	<b>Welding torch cooling, post-flow time</b> Setting 1–60 min. (ex works 5 min.)
<b>tL</b>	<b>Temperature error limit</b> Setting 50 - 80°C / 122 - 176°F (factory setting 70°C / 158°F)
<b>FLo</b>	<b>Flow monitoring</b> <input type="checkbox"/> <b>oFF</b> ----- Function disabled <input type="checkbox"/> <b>on</b> ----- Function enabled (factory setting)
<b>FLt</b>	<b>Flow error limit</b> Setting 0.5 l - 2.0 l / 0.13 gal - 0.53 gal (factory setting 0.6 l / 0.16 gal)
<b>rSc</b>	<b>Reset Cool</b> <input type="checkbox"/> <b>on</b> ----- Function enabled <input type="checkbox"/> <b>oFF</b> ----- Function disabled (factory setting)
<b>SrU</b>	<b>Service menu</b> Any changes to the service menu should be agreed with the authorised service personnel.
<b>rES</b>	<b>Reset (to factory setting)</b> <input type="checkbox"/> <b>oFF</b> ----- Disabled (ex works) <input type="checkbox"/> <b>cFu</b> ----- Reset the values in the machine configuration menu <input type="checkbox"/> <b>cPL</b> ----- Complete reset of all values and settings Resetting is performed when exiting the menu ( <b>End</b> ).
	<b>Software version query</b> System bus ID and version number are separated by a dot. Example: 07.0040 = 07 (system bus ID) 0.0.4.0 (version number)
<b>ALt</b>	<b>Show warnings &gt; see 6.1 chapter</b> <input type="checkbox"/> <b>oFF</b> ----- Function disabled (ex works) <input type="checkbox"/> <b>on</b> ----- Function enabled
<b>ALF</b>	<b>Fuse protection warning</b> <input type="checkbox"/> <b>oFF</b> ----- Function disabled (factory setting) <input type="checkbox"/> <b>on</b> ----- Function enabled



Display	Setting/selection
<b>FUS</b>	<b>Dynamic power adjustment &gt; see 5.10 chapter</b>
<b>SP</b>	<b>Special parameters menu</b>
<b>2tc</b>	<b>Non-latched operation (version C) &gt; see 5.2.5.6 chapter</b> <input type="checkbox"/> on -----Function enabled <input type="checkbox"/> off -----Function disabled (ex works)
<b>rcd</b>	<b>Welding current actual value display &gt; see 4.2 chapter</b> <input type="checkbox"/> on -----Actual value display <input type="checkbox"/> off -----Nominal value display
<b>PUO</b>	<b>Pulsed TIG welding (thermal)</b> <input type="checkbox"/> on -----Function enabled (ex works) <input type="checkbox"/> off -----For special applications only
<b>ovw</b>	<b>Filler wire welding, operating mode <sup>2</sup></b> <input type="checkbox"/> 1-0 -----Filler wire operation for automated applications, wire is fed when current flows <input type="checkbox"/> 2t -----Non-latched operating mode (ex works) <input type="checkbox"/> 3t ----- 3rd cycle operating mode <input type="checkbox"/> 4t -----Latched operating mode
<b>LAS</b>	<b>TIG antistick &gt; see 5.2.7 chapter</b> <input type="checkbox"/> on -----function active (factory setting). <input type="checkbox"/> off -----function inactive.
<b>AVL</b>	<b>AC average value controller <sup>1</sup></b> <input type="checkbox"/> on -----Function enabled (ex works) <input type="checkbox"/> off -----Function disabled
<b>AAA</b>	<b>activArc voltage measuring</b> <input type="checkbox"/> on -----Function enabled (ex works) <input type="checkbox"/> off -----Function disabled
<b>SAO</b>	<b>Error output to interface for automated welding, contact SYN_A</b> <input type="checkbox"/> off -----AC synchronisation or hot wire (ex works) <input type="checkbox"/> FSn -----Error signal, negative logic <input type="checkbox"/> FSp -----Error signal, positive logic <input type="checkbox"/> RuC -----AVC (Arc voltage control) connection
<b>CLI</b>	<b>Minimum current limit (TIG) &gt; see 5.1.2 chapter</b> Depending on the set tungsten electrode diameter <input type="checkbox"/> off -----Function disabled <input type="checkbox"/> on -----Function enabled (ex works)
<b>FAU</b>	<b>Fast take-over of control voltage (automation) <sup>3</sup></b> <input type="checkbox"/> on -----Function enabled <input type="checkbox"/> off -----Function disabled (ex works)
<b>dcP</b>	<b>Welding current polarity switch (dc+) with TIG DC <sup>1</sup></b> <input type="checkbox"/> on -----Polarity switch released <input type="checkbox"/> off -----Polarity switch blocked; protects the tungsten electrode from being permanently damaged (ex works).

Display	Setting/selection
<b>GAS</b>	<p><b>Gas monitoring</b> Depending on where the gas sensor is situated, the use of a pilot static tube and the welding process monitoring phase.</p> <p><input type="checkbox"/> <b>0FF</b>----- Function disabled (ex works).</p> <p><input type="checkbox"/> <b>1</b>----- Monitoring during the welding process. Gas sensor between gas valve and welding torch (with pilot static tube).</p> <p><input type="checkbox"/> <b>2</b>----- Monitoring prior to the welding process. Gas sensor between gas valve and welding torch (without pilot static tube).</p> <p><input type="checkbox"/> <b>3</b>----- Permanent monitoring Gas sensor between gas cylinder and gas valve (with pilot static tube).</p>
<b>opt</b>	<p><b>Arc detection for welding helmets (TIG)</b> Modulated waviness for better arc detection</p> <p><input type="checkbox"/> <b>0</b>----- Function disabled</p> <p><input type="checkbox"/> <b>1</b>----- Medium intensity</p> <p><input type="checkbox"/> <b>2</b>----- High intensity</p>

<sup>1</sup> for AC welding machines only.

<sup>2</sup> For machines with filler wire (AW) only.

<sup>3</sup> for components for automated welding (RC) only.

## 6 Rectifying faults

All products are subject to rigorous production checks and final checks. If, despite this, something fails to work at any time, please check the product using the following flowchart. If none of the fault rectification procedures described leads to the correct functioning of the product, please inform your authorised dealer.

### 6.1 Warnings

Depending on the display options of the machine display, a warning message is displayed as follows:

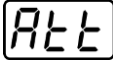
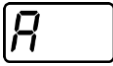
Display type - machine control	Display
Graphic display	
two 7-segment displays	
one 7-segment display	

The cause of the warning is indicated by a corresponding warning number (see table).

- In case of multiple warnings, these are displayed in sequence.
- Document machine warning and inform service personnel, if required.

Warning	Possible cause / remedy
1 Excess temperature	A shutdown is imminent due to excess temperature.
2 Half-wave failures	Check process parameters.
3 Torch cooling warning	Check coolant level and top up if necessary.
4 Shielding gas	Check shielding gas supply.
5 Coolant flow	Check min. flow rate. <sup>[2]</sup>
6 Wire reserve	Only a small amount of wire is left on the spool.
7 CAN-bus failure	Wire feeder not connected; automatic circuit-breaker of wire feed motor (reset the tripped automatic circuit-breaker by actuating).
8 Welding circuit	The welding circuit inductance is too high for the selected welding task.
9 WF configuration	Check WF configuration.
10 Partial inverter	One of several partial inverters is not supplying welding current.
11 Excess temperature, coolant <sup>[1]</sup>	Check temperature and switching thresholds. <sup>[2]</sup>
12 Welding monitor	The actual value of a welding parameter is outside the specified tolerance field.
13 Contact error	The resistance in the welding circuit is too high. Check earth connection.
14 Adjustment error	Switch the machine off and on. If the error persists, notify Service.
15 Mains fuse	The power limit of the mains fuse is reached and the welding power is reduced. Check the fuse setting.
16 Protective gas warning	Check the gas supply.
17 Plasma gas warning	Check the gas supply.
18 Forming gas warning	Check the gas supply.
19 Gas warning 4	reserved
20 Coolant temperature warning	Check coolant level and top up if necessary.

Warning	Possible cause / remedy
21 Excess temperature 2	reserved
22 Excess temperature 3	reserved
23 Excess temperature 4	reserved
24 Coolant flow warning	Check coolant supply. Check coolant level and top up if necessary. Check flow and switching thresholds. <sup>[2]</sup>
25 Flow 2	reserved
26 Flow 3	reserved
27 Flow 4	reserved
28 Wire stock warning	Check wire feeding.
29 Low wire 2	reserved
30 Low wire 3	reserved
31 Low wire 4	reserved
32 Tacho error	Fault of wire feeder - permanent overload of the wire drive.
33 Wire feed motor excess current	Excess current detected on wire feed motor.
34 JOB unknown	JOB selection was not performed because the JOB number is unknown.
35 Wire feed motor slave excess current	Excess current detected on wire feed motor slave (push/push system or intermediate drive).
36 Slave tacho error	Fault of wire feeder - permanent overload of the wire drive (push/push system or intermediate drive).
37 FAST-bus failure	Wire feeder not connected (reset by actuating the automatic cutout of the wire feed motor).
38 Incomplete component information	Check XNET component management.
39 Mains half-wave failure	Check supply voltage.
40 Mains undervoltage	Check supply voltage.
41 Cooling module not recognised	Check the cooling unit connection.
47 Battery (Bluetooth remote control)	Battery level is low (replace battery)



<sup>[1]</sup> only for XQ machine series

<sup>[2]</sup> See technical data for values and other switching thresholds.

## 6.2 Error messages (power source)

The possible error numbers displayed depend on the machine series and version!

Depending on the options of the machine display, a fault is shown as follows:

Display type - machine control	Display
Graphic display	
two 7-segment displays	
one 7-segment display	

The possible cause of the fault is signalled by a corresponding fault number (see table). In the case of an error, the power unit shuts down.

- Document machine errors and inform service staff as necessary.
- If multiple errors occur, these are displayed in succession.
- Document machine warning and inform service personnel, if required.
- If there are several errors in a control system, the error with the lowest error number (Err) is displayed. If this error is corrected, the next higher error number appears. This process is repeated until all errors have been resolved.

### Reset error (category legend)



<sup>A</sup> The error message disappears when the error is eliminated.

<sup>B</sup> The error message can be reset by pressing a push-button ◀.

All other error messages can only be reset by switching the machine off and on again.

Error (category)	Possible cause	Remedy
3 <sup>A, B</sup> Tacho error	Wire feed unit interference	Check connections (connections, pipes).
	Permanent overload of the wire drive.	Do not place the liner in tight radii. Check liner for smooth movement.
4 <sup>A</sup> Excess temperature	Power source overheated	Allow the switched on machine to cool down.
	Fan blocked, dirty or defective.	Check fan and clean or replace.
	Air inlet or outlet blocked.	Check air inlet and outlet.
5 Mains overvoltage	Mains voltage too high	Check the mains voltages and compare with the power source connection voltages.

Error (category)	Possible cause	Remedy
7 <sup>B</sup> Low coolant level	low flow rate	Fill coolant.
		Check coolant flow - remove kinks in hose package.
		Adjust flow threshold. <sup>[1]</sup> <sup>[3]</sup>
		Clean water block.
	Pump does not turn	Turn the pump shaft.
	Air in the coolant circuit	Vent coolant circuit.
	Hose package not completely filled with coolant.	Switch the machine off and on again > pump running > filling process.
Operation with gas-cooled welding torch.	Deactivate torch cooling.	
	Connecting coolant feed and return to hose bridges.	
Failure of automatic circuit-breaker <sup>[2]</sup>	Reset automatic circuit-breaker.	
8 <sup>A, B</sup> Shielding gas error	No shielding gas	Check shielding gas supply.
	Pre-pressure too low.	Remove kinks in the hose package (nominal value: 4-6 bar pre-pressure).
9 Overvoltage on secondary	Overvoltage at output: Inverter error	Request service.
10 Earth fault (PE error)	Connection between welding wire and machine casing	Remove electrical connection.
11 <sup>A, B</sup> Fast shut-down	Removing the logical signal "robot ready" during the process.	Eliminate errors on the higher-level control.
16 <sup>A</sup> General pilot arc	Emergency stop circuit error	Check emergency stop circuit.
	Temperature error	See description of error 4.
	Short circuit on welding torch	Check welding torch.
	Request service	
17 <sup>B</sup> Cold wire error	See description of error 3.	See description of error 3.
18 <sup>B</sup> Plasma gas error	Low gas level	See description of error 8.
19 <sup>B</sup> Shielding gas error	Low gas level	See description of error 8.
20 <sup>B</sup> Low coolant level	see description of error 7.	See description of error 7.
22 <sup>A</sup> Excess coolant temperature <sup>[1]</sup>	Coolant overheated <sup>[3]</sup>	Allow the switched on machine to cool down.
	Fan blocked, dirty or defective.	Check fan and clean or replace.
	Air inlet or outlet blocked.	Check air inlet and outlet.
23 <sup>A</sup> Excess temperature of the HF choke	External XF ignition unit overheated	Allow the switched on machine to cool down.
24 <sup>B</sup> Pilot arc ignition error	Pilot arc cannot ignite.	Check welding torch equipment.
25 <sup>B</sup> Forming gas error	Low gas level	See description of error 8.
26 <sup>A</sup> Excess pilot arc module temperature	Pilot arc module overheated	See description of error 4.
32 Error I>0 <sup>[1]</sup>	Current recording faulty	Request service.

Error (category)	Possible cause	Remedy
33 Error UIST <sup>[1]</sup>	Voltage recording faulty	Eliminate short circuit in welding circuit.
		remove external sensor voltage.
		Request service.
34 Electronics error	A/D-channel error	Switch the machine off and on again.
		Request service.
35 Electronics error	Slope error	Switch the machine off and on again.
		Request service.
36  -Error	 -Conditions violated.	Switch the machine off and on again.
		Request service.
37 Electronics error	Temperature error	Allow the switched on machine to cool down.
38 Error IIST <sup>[1]</sup>	Short circuit in welding circuit before welding.	Eliminate short circuit in welding circuit.
		Request service.
39 Electronics error	Secondary overvoltage	Switch the machine off and on again.
		Request service.
40 Electronics error	I>0 error	Request service.
47 <sup>B</sup> Bluetooth error	-	Observe accompanying documentation for Bluetooth function.
48 <sup>B</sup> Ignition error	no ignition at process start (automated machines).	Check wire feeding
		Check load cable connections in welding current circuit.
		clean corroded surfaces on workpiece before welding if necessary.
49 <sup>B</sup> Arc interruption	An arc interruption occurred during welding with an automated system.	Check wire feeding.
		Adjust welding speed.
50 <sup>B</sup> Program number	Internal error	Request service.
51 <sup>A</sup> Emergency stop	The emergency stop circuit of the power source has been activated.	Disable the activation of the emergency stop circuit (release protective circuit).
52 No wire feeder	After switching on the automated system, no wire feeder (DV) was detected.	Check or connect the control lines of the wire feeders;
		Check the identification number of the automated wire feeder (for 1DV: number 1, for 2DV: each a wire feeder with number 1 and a wire feeder with number 2).
53 <sup>B</sup> No wire feeder 2	Wire feeder 2 not detected.	Check control cable connections.
54 VRD error	Open circuit voltage reduction error.	if necessary, disconnect external machine from the welding circuit.
		Request service.
55 <sup>B</sup> Excess wire feeder current	Excess current detected on wire feed mechanism.	Do not place the liner in tight radii.
		Check liner for smooth movement.

Error (category)	Possible cause	Remedy
56 Mains phase failure	One phase of the mains voltage has failed.	Check mains connection, mains plug and mains fuses.
57 <sup>B</sup> Slave tacho error	Wire feeder fault (slave drive).	Check connectors, cables, connections.
	Permanent overload of the wire drive (slave drive).	Do not place the liner in tight radii. Check liner for smooth movement.
58 <sup>B</sup> Short circuit	Check welding circuit for short circuit.	Check welding current circuit.
		Place welding torch on an insulated surface.
59 Incompatible machine	A machine connected to the system is not compatible.	Disconnect incompatible machine from system.
60 Incompatible software	A machine's software is not compatible.	Request service.
61 Welding monitor	The actual value of a welding parameter is outside the specified tolerance field.	Observe tolerance fields.
		Adjust welding parameters.
62 System component <sup>[1]</sup>	System component not found.	Request service.
63 Mains voltage error	Operating and mains voltage are incompatible	Check or adjust operating and mains voltage

<sup>[1]</sup> only for XQ. machine series

<sup>[2]</sup> not for XQ. machine series

<sup>[3]</sup> See technical data for values and other switching thresholds.

## 6.3 Resetting welding parameters to the factory settings

**All customised welding parameters that are stored will be replaced by the factory settings.**

To reset the welding parameters or machine settings to the factory settings, select parameter  $\overline{rE5}$  in the service menu  $\overline{5rU}$  > see 5.11 chapter.

## 6.4 Display machine control software version

The query of the software versions only serves to inform the authorised service staff. It is available in the machine configuration menu > see 5.11 chapter.



**7 Appendix**  
**7.1 Parameter overview – setting ranges**  
**7.1.1 TIG welding**

Name	Display			Setting range	
	Code	Standard	Unit	min.	max.
Gas pre-flow time	$\overline{GPr}$	0,5	s	0	- 20
Electrode diameter (metric)	$\overline{ndR}$	2,4	mm	1,0	- 4,8
Electrode diameter (imperial)	$\overline{ndR}$	93	mil	40	- 187
Ignition optimisation	$\overline{cor}$	100	%	25	- 175
Ignition current (per cent of $\overline{iI}$ )	$\overline{iSt}$	50	%	1	- 200
Ignition current (absolute, power source dependent)	$\overline{iSt}$	-	A	-	- -
Start time	$\overline{tSt}$	0,01	s	0,01	- 20,0
Slope time (time from $\overline{iSt}$ to $\overline{iI}$ )	$\overline{tUP}$	0,00	s	0,00	- 20,0
Main current (power source dependent)	$\overline{iI}$	-	A	-	- -
Slope time (time from $\overline{iI}$ to $\overline{i2}$ )	$\overline{tS1}$	0,00	s	0,00	- 20,0
Slope time (time from $\overline{i2}$ to $\overline{iI}$ )	$\overline{tS2}$	0,00	s	0,00	- 20,0
Secondary current (per cent of $\overline{i2}$ )	$\overline{i2}$	50	%	1	200
Secondary current (absolute, power source dependent)	$\overline{i2}$	-	A	-	-
Slope time (time from $\overline{iI}$ to $\overline{iEd}$ )	$\overline{tdn}$	0,00	s	0,00	- 20,0
End current (per cent of $\overline{iI}$ )	$\overline{iEd}$	20	%	1	- 200
End current (absolute, power source dependent)	$\overline{iEd}$	-	A	-	- -
End current time	$\overline{tEd}$	0,01	s	0,01	- 20,0
Gas post-flow time	$\overline{GPE}$	8	s	0,0	- 40,0
activArc (main current dependent)	$\overline{AAP}$			0	- 100
Welding tasks (JOB)	$\overline{Job}$	1		1	- 100
spotArc time	$\overline{tP}$	2	s	0,01	- 20,0
spotmatic time ( $\overline{StS} > \overline{on}$ )	$\overline{tP}$	200	ms	5	- 999
spotmatic time ( $\overline{StS} > \overline{OFF}$ )	$\overline{tP}$	2	s	0,01	- 20,0
JOB presets	$\overline{cPJ}$	-		1	100

## 7.1.1.1 Pulse parameters

Name	Display			Setting range	
	Code	Standard	Unit	min.	max.
Pulse current (average value pulsing)	$I_{PL}$	140	%	1	200
Pulse time (thermal pulsing)	$t_I$	0,01	s	0,00	- 20,0
Pulse pause time (thermal pulsing)	$t_2$	0,01	s	0,00	- 20,0
Pulse balance (average value pulsing, AC and DC)	$b_{RL}$	50,0	%	0,1	- 99,9
Pulse frequency (average value pulsing, DC)	$F_{rE}$	2,00	Hz	0,10	- 20000
Pulse frequency (average value pulsing, AC)	$F_{rE}$	2,00	Hz	0,10	- 5,00

## 7.1.1.2 AC parameters

Name	Display			Setting range	
	Code	Standard	Unit	min.	max.
Balance	$b_{RL}$	65	%	40	- 90
Frequency	$F_{rE}$	50	Hz	30	- 300
AC commutation optimisation	$t_{CO}$	auto		1	- 100
Amplitude balance	$R_{bA}$	100	%	70	- 160

## 7.1.2 MMA welding

Name	Display			Setting range	
	Code	Standard	Unit	min.	max.
Hot start current (per cent of $I_{HI}$ )	$I_{HE}$	120	%	1	- 200
Hot start current (absolute, power source dependent)	$I_{HE}$	-	A	-	- -
Hot start time	$t_{HE}$	0,5	s	0,0	- 10,0
Main current (power source dependent)	$I_{HI}$	-	A	-	- -
Arcforce	$R_{rC}$	0		-40	- 40
JOB presets	$c_{PU}$	-		102	- 108
JOB presets (CEL)	$c_{PU}$	-		109	- 116

### 7.1.2.1 Pulse parameters

Name	Display			Setting range	
	Code	Standard	Unit	min.	max.
Pulse current (average value pulsing)	<b>[iPL]</b>	142		1	- 200
Pulse balance (average value pulsing, AC and DC)	<b>[bAL]</b>	30	%	0,1	- 99,9
Pulse frequency (average value pulsing, DC)	<b>[FrE]</b>	1,2	Hz	0,1	- 500
Pulse frequency (average value pulsing, AC)	<b>[FrE]</b>	1,2	Hz	0,1	- 5

### 7.1.2.2 AC parameters

Name	Display			Setting range	
	Code	Standard	Unit	min.	max.
Frequency	<b>[FrE]</b>	100	Hz	30	- 300
Balance	<b>[bAL]</b>	60	%	40	- 90

### 7.1.3 Global parameters

Name	Display			Setting range	
	Code	Standard	Unit	min.	max.
Standby	<b>[SbA]</b>	20	m	5	- 60
Re-ignite after arc interruption	<b>[i tR]</b>	Job	s	0,1	- 5
Torch mode	<b>[tOd]</b>	1	-	1	- 6
Up/down speed	<b>[uUd]</b>	10	-	1	1 100
Current jump	<b>[dI]</b>	1	A	1	- 20
Retrieval of JOB number	<b>[nrJ]</b>	100	-	1	- 100
Start JOB	<b>[StJ]</b>	1	-	1	100
Minimum current - foot-operated remote control (AC)	<b>[i Fr]</b>	10	A	3	- 50
Torch cooling, follow-up time	<b>[ct]</b>	7	-	1	- 60
Torch cooling, temperature error limit	<b>[tE]</b>	70	C	50	- 80
Torch cooling, temperature error limit (imperial)	<b>[tE]</b>	158	F	122	- 176
Torch cooling, flow error limit	<b>[FLo]</b>	0,6	l	0,5	- 2,0
Torch cooling, flow error limit (imperial)	<b>[FLo]</b>	0.16	gal	0.13	- 0.53
Dynamic power adjustment	<b>[FUS]</b>	16	-	10	- 32
Arc detection for welding helmets (TIG)	<b>[oPt]</b>	0	-	0	- 2

## 7.2 Searching for a dealer

Sales & service partners  
[www.ewm-group.com/en/specialist-dealers](http://www.ewm-group.com/en/specialist-dealers)



"More than 400 EWM sales partners worldwide"